

# IRON AGE ARCHITECTURAL METALS®

Italian Architectural Metal Components

Forged Steel ❖ Stainless Steel ❖ Aluminum

**ORLANDO, FLORIDA**



## QUICK REFERENCE CATALOG #7

[www.ironagemetals.com](http://www.ironagemetals.com)

Phone: 407-293-5788

Fax: 407-295-6847

Toll Free: 800-299-5788







# IRON AGE ARCHITECTURAL METALS®

Italian Architectural Forged Steel Components

2401 Clark Street Apopka, FL 32703

Tel: 407-293-5788 • 800-299-5788

Fax: 407-295-6847

[www.ironagemetals.com](http://www.ironagemetals.com)



Iron Age Architectural Metals® is centrally located in Metro Orlando, with a beautiful showroom offering the largest inventory of Ornamental Iron components in Florida, as well as Sample Designs to use as inspiration for your project. Our metal work is accessible and on display, rather than relying on ill-representative catalogues.

Our expert staff can handle any inquiry from general interest questions, to designers needing exact industry specifications. We can also assist with design ideas and layouts, as well as any special orders you might need. And unlike our competitors, we have a fleet of trucks that can personally deliver your order directly to the job site, your home, or your shop, reducing overall costs up to 40%!

Conveniently located in Central Florida, our state-of-the-art warehouse has a vast inventory of ornamental metals readily available to use in your renovation or fabrication project. Our stock includes forged steel and aluminum as well as wrought iron, cast iron, steel, cast aluminum, and brass. Our inventory of hand forged iron and wrought iron balusters, handrails, burglar bars, brackets, fittings (including pipe) and rosettes for staircases, balustrades or railings, are just some of the architectural metal components you'll find on hand.

Contact us for a quote or visit our showroom to inquire about all the services available to you. We are conveniently located at 2401 Clark Street in Apopka adjacent to Surplus Steel & Supply. Showroom hours are Monday through Friday, 8:00 a.m. to 5:00 p.m. Closed for lunch 12:00 p.m. to 1:00 p.m.

***Iron Age Architectural Metals® has the largest inventory of Ornamental Iron in Florida!***

Authorized Distributor

Proudly Affiliated with



# TABLE OF CONTENTS

2-4	Introduction	139-142		Shoes, Bushings and Baskets
5-18	 Scrolls	143-146		Ring and Spheres
19-30	 Rosettes	147-154		Spear Points
31-32	 Snap - Ons	155-156		Finials and Plates
33-62	 Panels	157-162		Flowers and Ornaments
63-102	 Pickets	163-168		Accessories
103-108	 Belly Pickets	169-184		Aluminum
109-116	 Newel Posts	185-194		Hand Carved Stair Parts
117-130	 Handrail and Long Bars	195-216		Powder Coated Pickets
131-136	 Pierced Bars	217-259		ARTEFERRO INOX
137-138	 Gate Tops	260-264		Catalogs





# FORGINGS

Quick Reference Catalog #7

While wrought iron has been a part of the architecture styles seen throughout Europe for centuries, it is accurate to note that in the United States this is becoming a growing trend in regional and even national appeal. Of great interest is the consumer involvement in developing their own projects for a myriad of applications. We are proud to introduce new designs that take the guess work out of “what is next” in the evolving world of home building, commercial endeavors, or DIY projects. As a manufacturer we welcome a review of your own

designs. Pulling from an international portfolio of over 40,000 different component profiles, we may have what you are searching for to tackle that next project. For immediate sourcing We incorporate a national steel distribution network for fast, reliable sourcing of the over 3,000 wrought iron parts carried in our Houston, TX master warehouse. Many of the top sellers including balusters, newels, scrolls, rosettes, panels, decorative bar, and miscellaneous metal art accents can be sourced immediately within your local markets.

• <b>Scrolls.....</b>	<b>05</b>	• <b>Pierced Bars.....</b>	<b>131</b>
• <b>Rosettes.....</b>	<b>19</b>	• <b>Gate Tops.....</b>	<b>137</b>
• <b>Snap-Ons.....</b>	<b>31</b>	• <b>Shoes, Bushings &amp; Baskets.....</b>	<b>139</b>
• <b>Panels.....</b>	<b>33</b>	• <b>Ring and Spheres .....</b>	<b>143</b>
• <b>Pickets.....</b>	<b>63</b>	• <b>Spear Points.....</b>	<b>147</b>
• <b>Belly Pickets.....</b>	<b>103</b>	• <b>Finials and Plates.....</b>	<b>155</b>
• <b>Newel Posts.....</b>	<b>109</b>	• <b>Flowers and Ornaments.....</b>	<b>157</b>
• <b>Handrail.....</b>	<b>117</b>	• <b>Accessories.....</b>	<b>163</b>
		• <b>Aluminum.....</b>	<b>169</b>





**SCROLLS**

Quick Reference # 7 2011

# New Items

Steel Tubular



**Art. 630/1**  
Mtl 3/4" x 3/8" sq.  
W 4 1/2" x H 13 3/16"  
Wt. 3.04 lbs.



**Art. 650/1**  
Mtl 1/2" dia.  
W 5 1/8" x H 15"  
Wt. 0.81 lbs.



**Art. 650/2**  
Mtl 1/2" dia.  
W 5 5/16" x H 14 3/16"  
Wt. 0.81 lbs.



**Art. 650/3**  
Mtl 1/2" dia.  
W 4 3/4" x H 9 1/4"  
Wt. 0.74 lbs.



**Art. 650/4**  
Mtl 1/2" dia.  
W 5 5/16" x H 10 1/16"  
Wt. 0.74 lbs.



**Art. 630/3**  
Mtl 3/4" x 3/8" sq.  
W 4 1/2" x H 10 1/4"  
Wt. 2.73 lbs.



**Art. 630/4**  
Mtl 3/4" x 3/8" sq.  
W 4 3/4" x H 7 1/2"  
Wt. 3.75 lbs.



**Art. 630/5**  
Mtl 3/4" x 3/8" sq.  
W 3 15/16" x H 4 3/4"  
Wt. 1.21 lbs.



**Art. 630/6**  
Mtl 3/4" x 3/8" sq.  
W 3 1/8" x H 5 1/8"  
Wt. 1.06 lbs.



**Art. 658/2**  
Mtl 1/2" sq.  
W 9 1/2" x H 13 13/16"  
Wt. 2.42 lbs.



**Art. 658/1**  
Mtl 1/2" sq.  
W 9 1/2" x H 15 3/4"  
Wt. 2.64 lbs.



**Art. 92/C/4  
Left**  
Mtl 1/2" x 1/4"  
W 4 13/32" x H 20 1/16"  
Wt. 1.1 lbs.



**Art. 92/C/5  
Right**  
Mtl 1/2" x 1/4"  
W 4 13/32" x H 20 1/16"  
Wt. 1.1 lbs.



**Art. 658/4**  
Mtl 1/2" sq.  
W 7 7/8" x H 18 1/8"  
Wt. 2.64 lbs.

Shown: 658/2, 658/1





# New Items

## Steel Tubular



**Art. 651/4**  
Mtl 1/2" sq.  
W 5 1/8"  
H 14 31/32"  
Wt. 0.58 lbs.



**Art. 651/3**  
Mtl 1/2" sq.  
W 5 5/16"  
H 14 3/16"  
Wt. 0.57 lbs.



**Art. 651/1**  
Mtl 1/2" sq.  
W 4 23/32"  
H 9 1/4"  
Wt. 0.52 lbs.



**Art. 651/2**  
Mtl 1/2" sq.  
W 5 5/16"  
H 10 1/16"  
Wt. 0.53 lbs.

Shown: 651/3



ARTEFERRO

Shown: 24/F/2



ARTEFERRO



**Art. 24/F/2**  
Mtl 1/2" sq.  
W 11 13/16" x H 8 21/32"  
Wt. 4.36 lbs.



**Art. 1143/1**  
Mtl 1/2" sq.  
W 8 15/32" x H 7 1/2"  
Wt. 3.96 lbs.

6 9/32"



**Art. 1143/2**  
Mtl 1/2" sq.  
W 7 9/32" x H 11 13/16"  
Wt. 3.04 lbs.

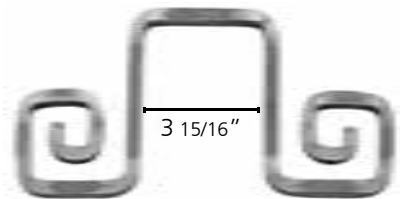

**Art. 1145/3**  
Mtl 1/2" sq.  
W 12 13/32" x H 6 11/16"  
Wt. 2.38 lbs.

3 15/16"



Art. GD0048

W 94 1/2"  
H 3 15/16"



Art. GD0049

W 94 1/2"  
H 5 1/8"



Art. GD0050

W 96 7/16"  
H 5 7/8"



Art. GD0051

W 99 3/16"  
H 3 15/16"



Art. 1281/11

Mtl. 13/16" x 5/16"  
W 43 5/16"  
H 12 7/32"  
Wt. 16.28 lbs.

Shown: 1281/4







**HOT FORGED  
ENDS**



**Art. 80/A/1**  
Mtl 1/2" x 1/4"  
W 4 11/32" x H 10 5/8"  
Wt. 0.73 lbs.



**Art. 80/A/3**  
Mtl 1/2" x 1/4"  
W 2 3/8" x H 4 5/16"  
Wt. 0.31 lbs.

Shown: 80/A/1, 80/A/3





ARTEFERRO

Shown: 80/A/9



Art. 80/A/11  
Mtl 1/2" x 1/4"  
W 2 9/16" x H 5 29/32"  
Wt. 0.42 lbs.



Art. 80/A/12  
Mtl 1/2" x 1/4"  
W 2 3/4" x H 7 1/2"  
Wt. 0.51 lbs.

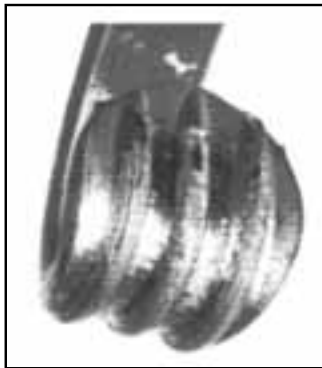

HOT FORGED  
ENDS

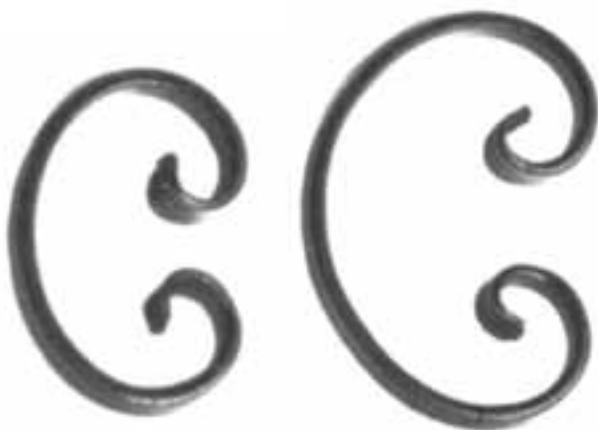

Art. 80/A/9  
Mtl 1/2" x 1/4"  
W 2 3/4" x H 4 1/8"  
Wt. 0.35 lbs.

Art. 80/A/10  
Mtl 1/2" x 1/4"  
W 3 3/4" x H 5 1/2"  
Wt. 0.48 lbs.

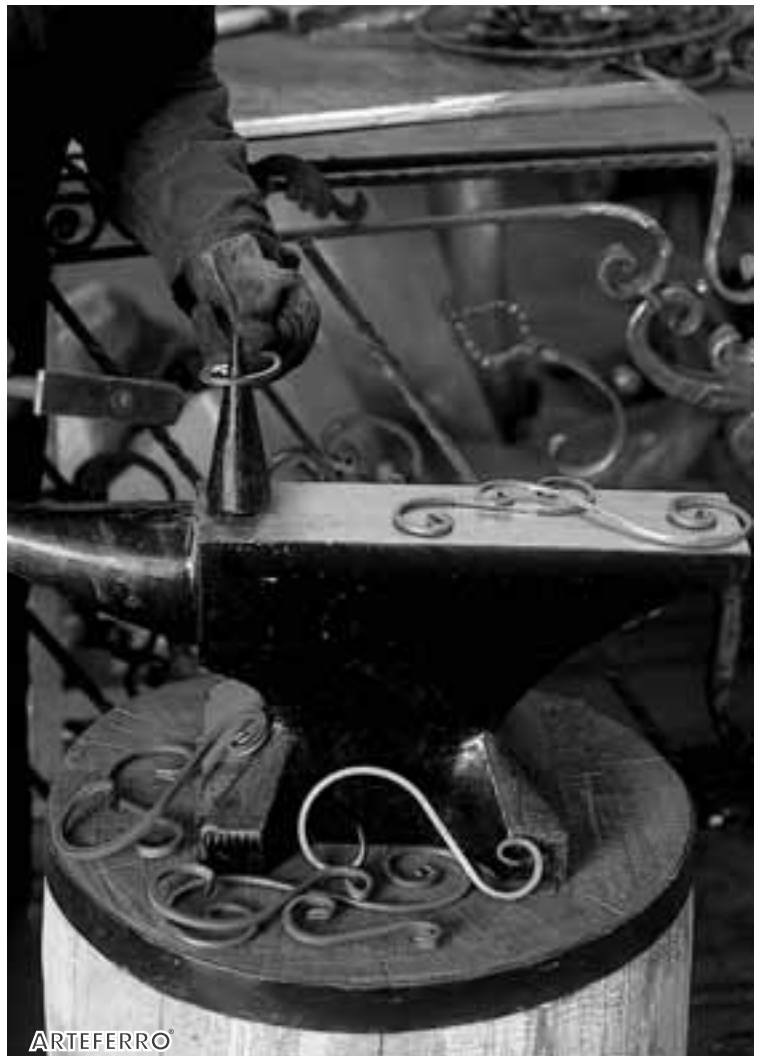

ARTEFERRO





ARTEFERRO



ARTEFERRO

Shown: 78/B/4, 80/A/1



ARTEFERRO



**Art. 84/7**  
Mtl 3/4" x 1/4"  
W 5 2/32" x H 8 7/8"  
Wt. 1.6 lbs.



**Art. 78/B/4**  
Mtl 9/16" sq.  
W 4 11/32" x H 8 21/32"  
Plain  
Wt. 2.1 lbs.



**Art. 93/4**  
Mtl 1/2" x 1/4"  
W 9 1/16" x H 13 25/32"  
Wt. 1.4 lbs.



**Art. 92/B/4**  
Mtl 1/2" x 1/4"  
W 6 9/32" x H 9 27/32"  
Wt. 1.5 lbs.



**Art. 94/3**  
Mtl 1/2" x 1/4"  
W 5 29/32" x H 7 7/8"  
Wt. 0.8 lbs.



**Art. 93/1**  
Mtl 1/2" x 1/4"  
W 12 19/32" x H 17 23/32"  
Wt. 1.8 lbs.



**Art. 93/3**  
Mtl 1/2" x 1/4"  
W 7 7/8" x H 17 23/32"  
Wt. 1.7 lbs.



**Art. 92/B/3**  
Mtl 1/2" x 1/4"  
W 13 25/32" x H 3 5/32"  
Wt. 0.8 lbs.



ARTEFERRO





**Art. 64/G/6**  
Mtl 1/2" x 1/4"  
W 2"  
H 9 1/16"  
Wt. 0.5 lbs.



**Art. 64/G/3**  
Mtl 1/2" x 1/4"  
W 4 1/8"  
H 5 29/32"  
Wt. 0.5 lbs.



**Art. 64/G/4**  
Mtl 1/2" x 1/4"  
W 2 3/8"  
H 4 1/8"  
Wt. 0.3 lbs.



**Art. 64/G/5**  
Mtl 1/2" x 1/4"  
W 2 3/8"  
H 4 1/8"  
Wt. 0.3 lbs.



**Art. 94/C/2**  
Mtl 1/8"  
W 6 11/16"  
H 5 1/2"  
Wt. 0.2 lbs.

**i** See page 27  
Art.1653/1  
Art.1652/1



**Art. 94/C/1**  
Mtl 1/8"  
W 5 1/8"  
H 3 15/16"  
Wt. 0.2 lbs.

Shown: 64/G/6, 94/C/1, 94/C/2, 94/C/3, 94/C/4



ARTEFERRO



**Art. 94/C/3**  
Mtl 3/8" dia.  
W 4 11/32"  
H 6 11/16"  
Wt. 0.6 lbs.



**Art. 94/C/4**  
Mtl 3/8" dia.  
W 4 11/32"  
H 6 11/16"  
Wt. 0.6 lbs.



**Art. 94/C/5**  
Mtl 3/8" dia.  
W 7 1/2" x H 10 5/8"  
Wt. 1.0 lbs.



**Art. 94/C/6**  
Mtl 3/8" dia.  
W 7 1/2" x H 10 5/8"  
Wt. 1.0 lbs.



**Art. GD0033**  
Mtl 5/8" x 3/8"  
W 3 15/16" approx.  
H 5 1/8" approx.  
Wt. 0.8 lbs.



**Art. GD0022/SX**  
Mtl 3/4" x 3/8"  
W 3 15/16" approx.  
H 9 9/16" approx.  
Wt. 1.5 lbs.



**Art. GD0022/DX**  
Mtl 3/4" x 3/8"  
W 3 15/16" approx.  
H 9 9/16" approx.  
Wt. 1.5 lbs.



**Art. GD0034**  
Mtl 5/8" x 3/8"  
W 12 1/4" approx.  
H 9 7/16" approx.  
Wt. 1.9 lbs.



**Art. GD0032**  
Mtl 5/8" x 3/8"  
W 9 1/16" approx.  
H 6 7/8" approx.  
Wt. 2.4 lbs.

**Art. GD0023/SX**  
Mtl 5/8" x 3/8"  
W 3 15/16" approx.  
H 9 9/16" approx.  
Wt. 1.2 lbs.

**Art. GD0023/DX**  
Mtl 5/8" x 3/8"  
W 3 15/16" approx.  
H 9 9/16" approx.  
Wt. 1.2 lbs.



**Art. GD0028**  
Mtl 5/8" x 3/8"  
W 3 15/16" approx.  
H 8 27/32" approx.  
Wt. 1.5 lbs.



**Art. GD0027**  
Mtl 5/8" x 5/16"  
W 3 15/16" approx.  
H 9 27/32" approx.  
Wt. 1.65 lbs.



**Art. GD0024**  
Mtl 5/8" x 3/8"  
W 3 15/16" approx.  
H 2 61/64" approx.  
Wt. 0.66 lbs.

**Art. GD0025**  
Mtl 3/4" x 3/8"  
W 3 15/16" approx.  
H 2 61/64" approx.  
Wt. 0.88 lbs.



**Art. GD0035**  
Mtl 5/8" x 3/8"  
W 1 3/16" approx.  
H x 6 7/8" approx.  
Wt. 0.4 lbs.



**Art. GD0026**  
Mtl 5/8" x 5/16"  
W 8 27/32" approx.  
H 2 3/4" approx.  
Wt. 1.0 lbs.



ARTEFERRO



Art. 1144/3  
Mtl 1/2" sq.  
W 5 23/32"  
H 13 25/32"  
Wt. 2.8 lbs.



Art. 1144/5  
Mtl 1/2" sq.  
W 6 11/16"  
H 13 3/16"  
Wt. 2.5 lbs.

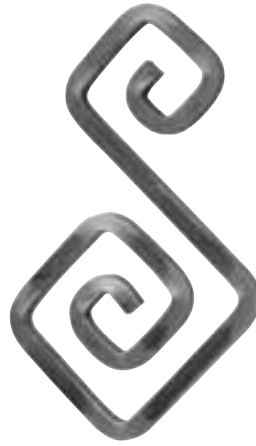

Art. 1144/6  
Mtl 1/2" sq.  
W 6 5/16"  
H 10 5/8"  
Wt. 2.2 lbs.



Art. 1144/4  
Mtl 1/2" sq.  
W 4 1/8"  
H 8 7/8"  
Wt. 1.5 lbs.



Art. 1144/1  
Mtl 1/2" sq.  
W 4 23/32"  
H 8 7/16"  
Wt. 2.5 lbs.



Art. 1144/2  
Mtl 1/2" sq.  
W 3 3/4"  
H 7 9/32"  
Wt. 1.5 lbs.



Art. 1145/3  
Mtl 1/2" sq.  
W 12 13/32"  
H 6 11/16"  
Wt. 2.6 lbs.





**Art. 73/1**  
Mtl 5/16" sq.  
W 4 11/32" x H 11 13/16"  
Wt. 1.0 lbs.



**Art. 73/2**  
Mtl 5/16" sq.  
W 4 11/32" x H 9 1/16"  
Wt. 0.6 lbs.



**Art. 73/3**  
Mtl 5/16" sq.  
W 3 17/32" x H 7 3/32"  
Wt. 0.5 lbs.

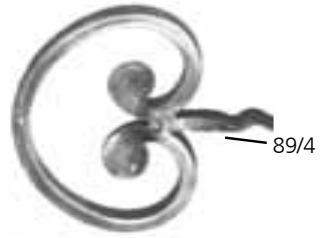

**Art. 89/2**  
Mtl 5/16" sq.  
W 4 15/16" x H 4 17/32"  
Wt. 0.5 lbs.



**Art. 1046/3**  
Mtl 1/2" sq.  
W 9 15/32" x H 17 5/32"  
Wt. 4.1 lbs.



**Art. 1046/4**  
Mtl 1/2" sq.  
W 7 9/32" x H 12 19/32"  
Wt. 2.5 lbs.



**Art. 1046/5**  
Mtl 1/2" sq.  
W 7 3/32" x H 17 17/32"  
Wt. 2.0 lbs.



**Art. 1046/6**  
Mtl 1/2" sq.  
W 4 1/8" x H 2 9/16"  
Wt. 0.9 lbs.



**Art. 1046/7**  
Mtl 1/2" sq.  
W 2 9/16" x H 4 1/8"  
Wt. 0.51 lbs.



ARTEFERRO



**Art. 1295/1**  
Mtl 1/2" dia.  
W 4 3/4"  
H 14 3/16"  
Wt. 2.1 lbs.



**Art. 1295/2**  
Mtl 1/2" dia.  
W 4 3/4"  
H 14 3/16"  
Wt. 1.8 lbs.



**Art. 1295/3**  
Mtl 1/2" dia.  
W 4 3/4"  
H 11 7/16"  
Wt. 1.7 lbs.



**Art. 1295/4**  
Mtl 1/2" dia.  
W 4 3/4"  
H 8 21/32"  
Wt. 1.4 lbs.



**Art. 1295/5**  
Mtl 1/2" dia.  
W 4 17/32"  
H 10 1/32"  
Wt. 1.83 lbs.



**Art. 1295/6**  
Mtl 1/2" dia.  
W 3 9/16"  
H 7 3/32"  
Wt. 1.23 lbs.



**Art. 1295/7**  
Mtl 1/2" dia.  
W 2 3/8"  
H 4 17/32"  
Wt. 0.73 lbs.



**Art. 635/3**  
Mtl 1/2" sq.  
W 4 11/32" x H 14 9/16"  
Wt. 1.73 lbs.



**Art. 635/4**  
Mtl 1/2" sq.  
W 3 3/4" x H 11 7/16"  
Wt. 1.33 lbs.



**Art. 625/3**



**Art. 635/1**  
Mtl 1/2" sq.  
W 4 15/16"  
H 17 23/32"  
Wt. 1.9 lbs.



**Art. 635/2**  
Mtl 1/2" sq.  
W 6 1/8"  
H 15 11/32"  
Wt. 2.04 lbs.



Shown: 1296/12

ARTEFERRO



**Art. 1296/12**  
Mtl 1/2" dia.  
W 3 9/16"  
H 5 5/16"  
Wt. 0.81 lbs.



**Art. 600/4**

Hammered Mtl



**Art. 1296/13**  
Mtl 1/2" dia.  
W 2 3/4"  
H 4 11/32"  
Wt. 0.7 lbs.

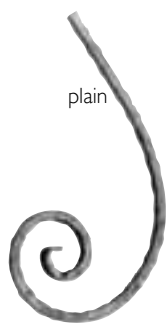

plain

**Art. 1038/3**  
Mtl 9/16" sq.  
W 7 7/8" x H 15 3/4"  
Plain  
Wt. 2.5 lbs.



**Art. 1039/3**  
Mtl 9/16" sq.  
W 3 17/32" x H 4 3/4"  
Hammered  
Wt. 0.9 lbs.



**Art. 1039/2**  
Mtl 9/16" sq.  
W 7 7/8" x H 11 13/16"  
Hammered  
Wt. 2.6 lbs.



**Art. 88/C/2**  
Mtl 3/4" x 1/4"  
W 9 1/4" x  
H 28 11/32"  
Wt. 3.3 lbs.



**Art. 540/1**  
Mtl 1/2" dia.  
W 9 7/8" x  
H 28 11/32"  
Wt. 3.4 lbs.

Shown: 1309/2



ARTEFERRO



(Art. 497/1)

**Art. 1309/1**  
Mtl 1/2" dia.  
W 4 5/16"  
H 17 3/4"  
Wt. 1.9 lbs.



(Art. 499/1)

**Art. 1309/2**  
Mtl 1/2" dia.  
W 4 5/16"  
H 17 3/4"  
Wt. 1.9 lbs.



(Art. 99/1)

**Art. 1309/3**  
Mtl 1/2" sq.  
W 4 5/16"  
H 17 3/4"  
Wt. 2.5 lbs.



(Art. 105/2)

**Art. 1309/4**  
Mtl 1/2" sq.  
W 4 5/16"  
H 17 3/4"  
Wt. 3 lbs.



(Art. 98/1)

**Art. 1309/5**  
Mtl 1/2" sq.  
W 4 5/16"  
H 17 3/4"  
Wt. 4.1 lbs.



**ROSETTES**

Quick Reference # 7 2011





New Items **New Items**

Floral Element 116/A/4



**Art. 1667/3**  
Mtl 9/16" x 5/16" sq.  
27" dia.  
Wt. 19.8 lbs.



Rosette on both sides

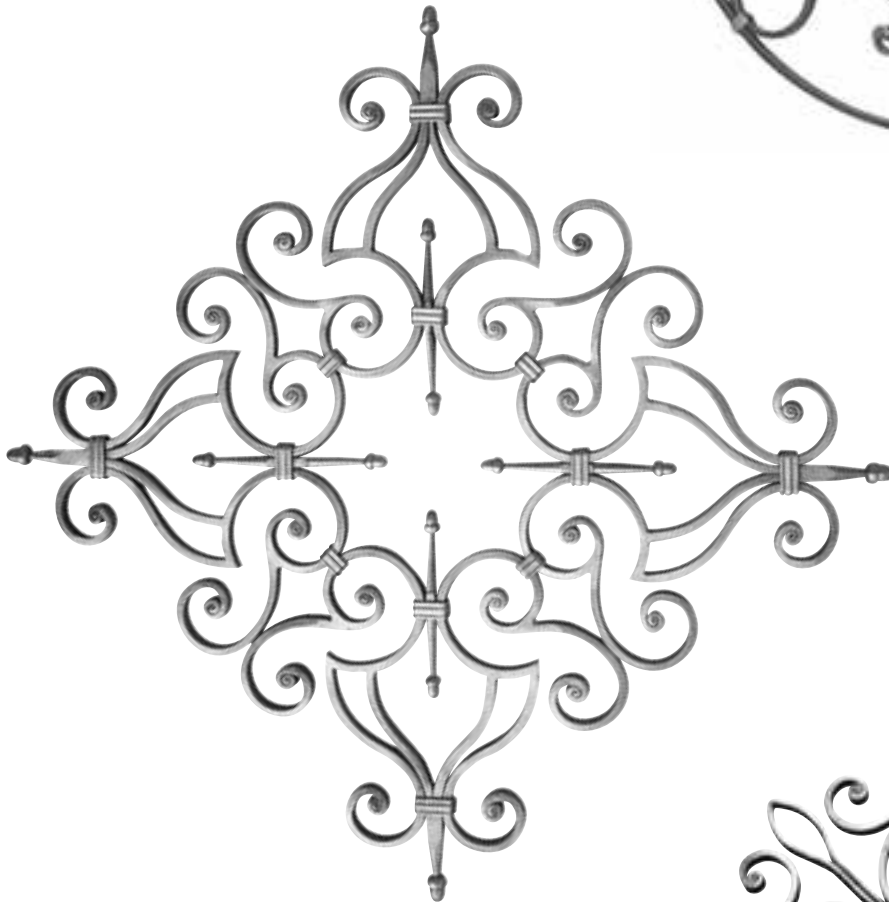

**Art. GD151/2**  
Mtl 9/16" x 5/16" sq.  
W 30 5/16" x H 21 21/32"  
Wt. 17.8 lbs.

**Art. 1667/2**  
Mtl 9/16" x 5/16" sq.  
23 1/4" dia.  
Wt. 12.1 lbs.

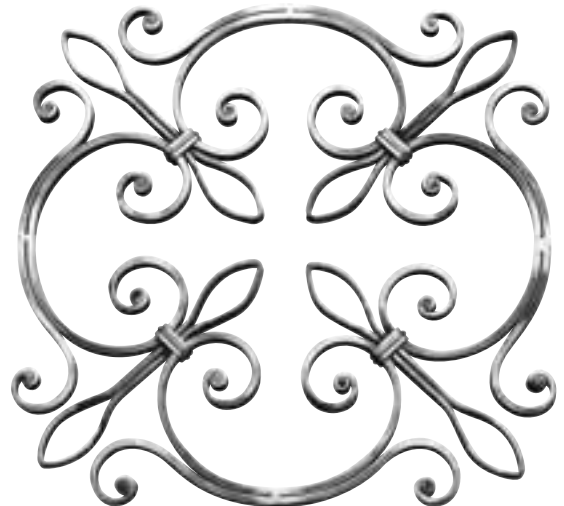

Shown: 1667/3



New Items **New Items**

Shown: 1668/2



**Art. 1668/2**  
Mtl 9/16" x 5/16" sq.  
20 11/16" dia.  
Wt. 11.22 lbs.

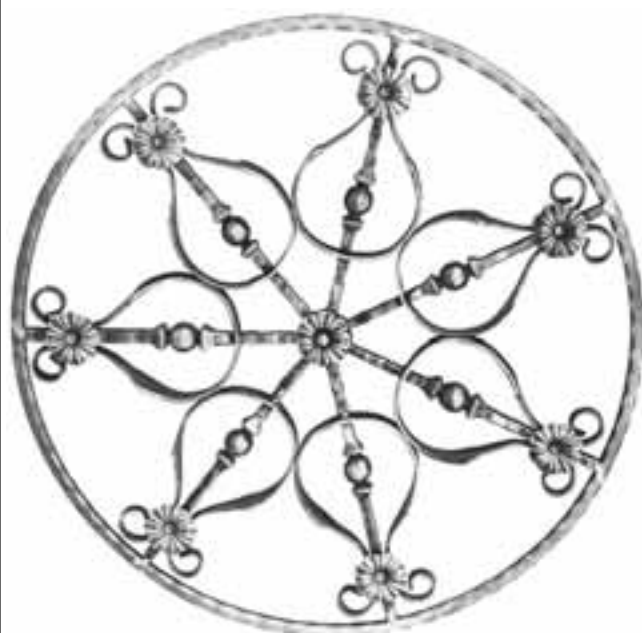

**Art. 718/1**  
Mtl 9/16" sq.  
28 15/16" dia.  
Wt. 28.6 lbs.

Shown: 718/1



New Items **New Items**

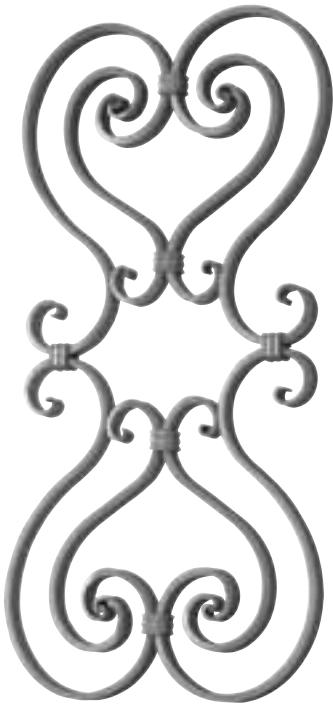

**Art. NEW0009**  
Mtl 5/8" x 1/4" sq.  
W 10 1/4" x H 20 9/32"  
Wt. 6.3 lbs.

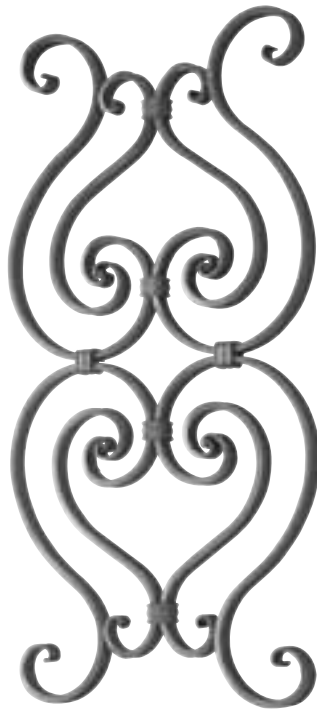

**Art. NEW0010**  
Mtl 5/8" x 1/4" sq.  
W 10 1/4" x H 20 9/32"  
Wt. 6.6 lbs.

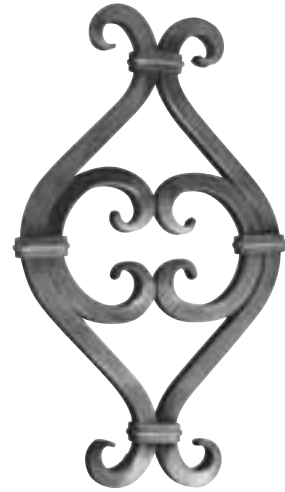

**Art. 1665/18**  
Mtl 9/16" sq.  
W 7 7/8" x H 13 13/32"  
Wt. 5.32 lbs.

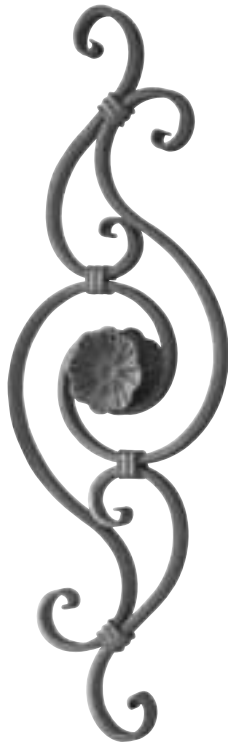

**Art. NEW0016**  
Mtl 5/8" x 1/4" sq.  
W 6 29/32" x H 20 3/32"  
Wt. 3.52 lbs.





Items 17/1 and 17/2 are identical except for the collar material which covers the weld points

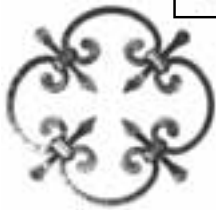

**Art. 17/1**  
Mtl 5/16" sq.  
9 27/32" dia.  
Wt. 2 lbs.



**Art. 17/2**  
Mtl 5/16" sq.  
9 27/32" dia.  
Wt. 1.7 lbs.

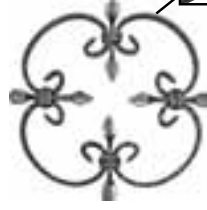

**Art. 23/1**  
Mtl 3/8" x 3/16"  
9 27/32" dia.  
Wt. 1.7 lbs.

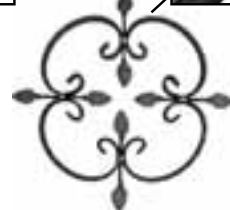

**Art. 23/2**  
Mtl 3/8" x 3/16"  
9 27/32" dia.  
Wt. 2.3 lbs.

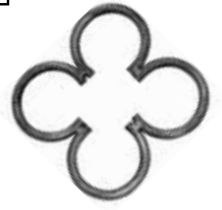

**Art. 1019/2**  
Mtl 1/2" sq.  
Mtl 9 13/32" dia.  
Wt. 2.14 lbs.

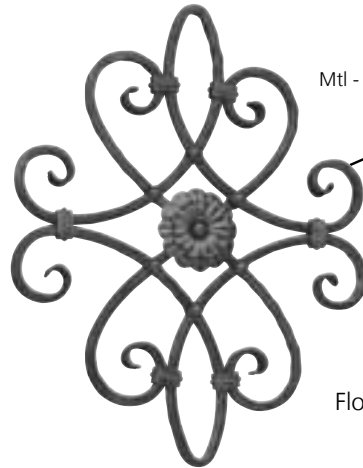

Mtl - 118/1



**Art. 26/C/1**  
Mtl 1/2" sq.  
W 16 15/16"  
H 20 7/8"  
Hammered bar  
Floral element on one side only  
Wt. 9.8 lbs.



Mtl - 118/17

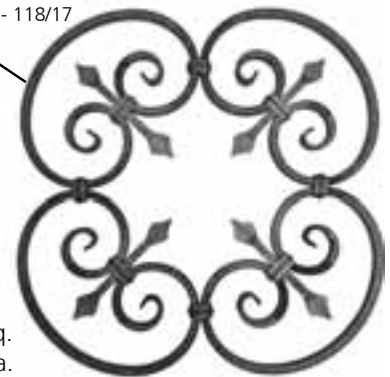

**Art. 24/3**  
Mtl 1/2" sq.  
23 5/8" dia.  
Wt. 13 lbs.



**Art. 24/2**  
Mtl 3/8" x 3/16"  
15" dia.  
Wt. 3.3 lbs.



**Art. 1009/1**  
Mtl 1/2" x 1/4"  
14 3/16" dia.  
Wt. 2.7 lbs.

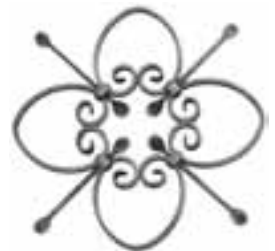

**Art. 1009/2**  
Mtl 1/2" x 1/4"  
16 15/16" dia.  
Wt. 3.5 lbs.



**Art. 1010/1**  
Mtl 1/2" sq.  
19 5/16" dia.  
Wt. 8.3 lbs.

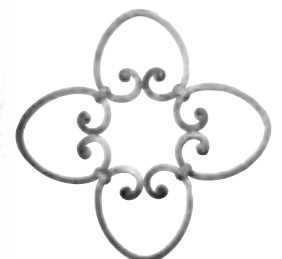

**Art. 1010/2**  
Mtl 1/2" sq.  
17 17/32" dia.  
Wt. 6.6 lbs.





Shown: 26/C/1



**Art. 446/4**  
Mtl 9/16" dia.  
22 1/4" dia.  
Floral element on  
one side only  
Wt. 12.54 lbs.

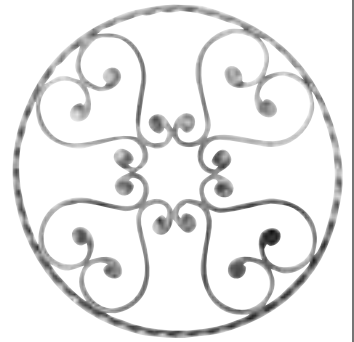

**Art. 451/1**  
Mtl 5/16" sq.  
22 21/32" dia.  
Wt. 6.4 lbs.

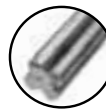

Mtl - 626/11

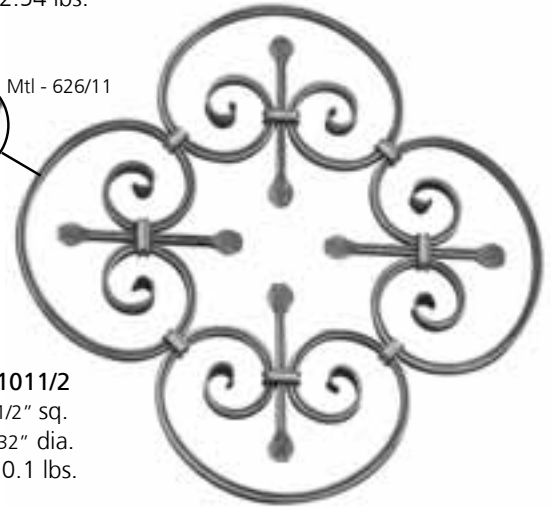

**Art. 1011/2**  
Mtl 1/2" sq.  
24 1/32" dia.  
Wt. 10.1 lbs.

Mtl - 1370/13

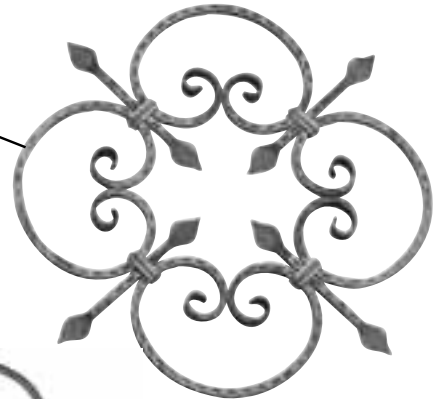
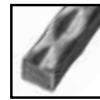

**Art. 1011/3**  
Mtl 1/2" sq.  
21 7/8" dia.  
Wt. 10.8 lbs.



**Art. 1014/2**  
Mtl 1/2" dia.  
Mtl 10 5/8" dia.  
Wt. 3.4 lbs.



**Art. 1010/3**  
Mtl 1/2" sq.  
11 7/16" dia.  
Wt. 4.4 lbs.



**Art. 1011/1**  
Mtl 3/8" dia.  
17 5/16" dia.  
Wt. 5.7 lbs.



**Art. 1012/1**  
Mtl 1/2" dia.  
22 1/16" dia.  
Wt. 11.44 lbs.

Sq Mtl - 623/5

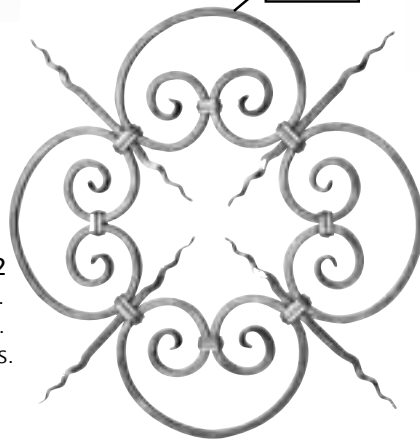

**Art. 1012/2**  
Mtl 1/2" sq.  
23 3/4" dia.  
Wt. 13.5 lbs.



**Art. 1028/2**  
Mtl 1/2" sq.  
24 13/16" dia.  
Wt. 16.1 lbs.



**Art. 1028/1**  
Mtl 1/2" sq.  
16 17/32" dia.  
Wt. 8.65 lbs.



**Art. 1017/3**  
Mtl 1/2" dia.  
Mtl 8 21/32" dia.  
Wt. 3.32 lbs.

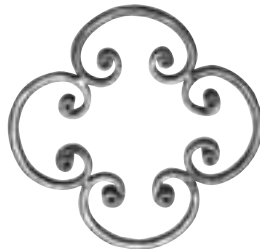

**Art. 1017/4**  
Mtl 1/2" dia.  
Mtl 10 27/32" dia.  
Wt. 2.81 lbs.



**Art. 460/1**  
Mtl 1/2" sq.  
W 18 1/8" x H 21 21/32"  
Wt. 11 lbs.



**Art. 52/H/3**  
Mtl 1/2" x 1/4"  
W 4 3/4" x H 11 13/16"  
Wt. 1.2 lbs.



Plain Round Mtl



**Art. 1657/1**  
(ex 9104/2)  
Mtl 5/8" x 5/16"  
W 16 5/32" x H 15 3/4"  
Wt. 6.6 lbs.

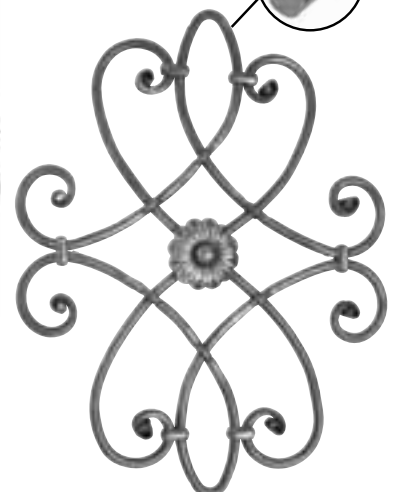

**Art. 1641/1**  
(ex 9104/3)  
Mtl 9/16" dia.  
W 18 23/32" x H 24"  
Wt. 13.2 lbs.

Shown: 1658/1

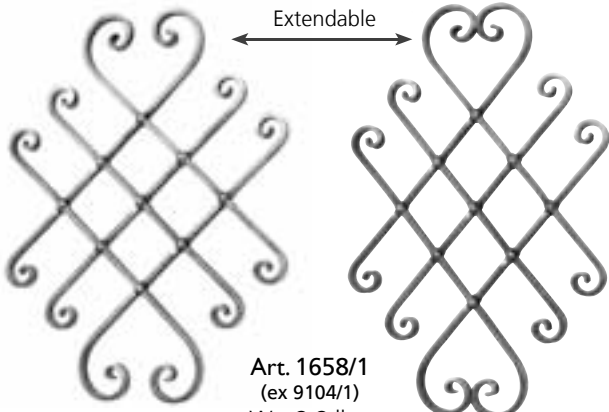

Art. 1658/1  
(ex 9104/1)  
Wt. 8.8 lbs.

Mtl 5/8" x 5/16"  
H 22 27/32"  
W 17 5/16"

Mtl 5/8" x 5/16"  
H 24 13/32"  
W 15"



Art. 1013/1  
Mtl 1/2" dia.  
11 5/8" dia.  
Wt. 5.3 lbs.



Art. 1013/2  
Mtl 1/2" sq.  
11 5/8" dia.  
Wt. 6.6 lbs.



Art. 1652/1  
(ex 9104/6)  
Mtl 1/2" x 1/4"  
9 27/32" dia.  
Wt. 1.8 lbs.



Art. 1653/1  
(ex 9104/7)  
Mtl 1/2" x 1/4"  
9 27/32" dia.  
Wt. 1.9 lbs.



Art. 1653/2  
(ex 9104/8)  
Mtl 1/2" x 1/4"  
9 27/32" dia.  
Wt. 1.6 lbs.

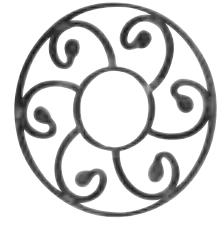

Art. 1652/5  
(ex 9104/8)  
Mtl 1/2" x 1/4"  
9 27/32" dia.  
Wt. 2.31 lbs.



Art. 1659/1  
(ex 9104/4)  
Mtl 9/16" sq.  
17 23/32" dia.  
Wt. 15 lbs.



Shown: 1659/1



Art. 1657/4  
(ex 9104/5)  
Mtl 5/8" x 5/16"  
W 15 3/4" x H 22 21/32"  
Wt. 8.8 lbs.





Shown: 679/2

**Art. 679/2**  
Mtl 1/2" dia.  
W 32 5/8" x H 32 5/8"  
Wt. 15.8 lbs.

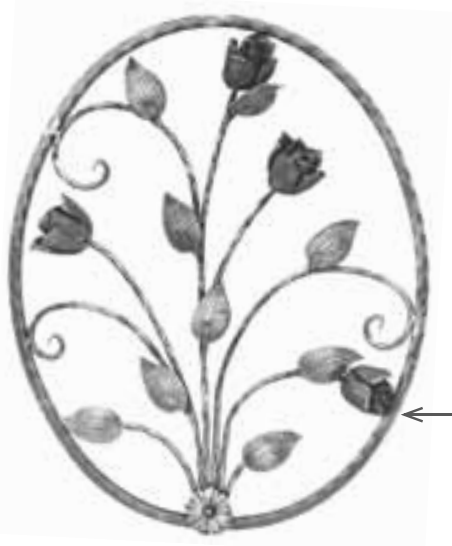
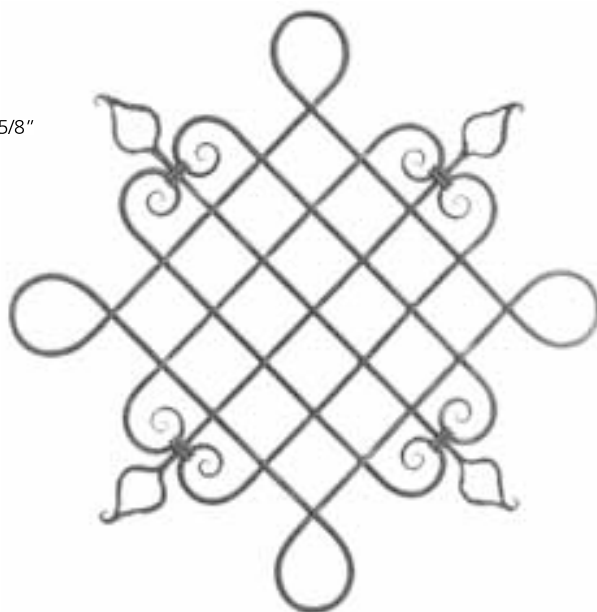

**Art. 720/1**  
Mtl 9/16"  
W 20 1/4" x H 26 3/8"  
Wt. 15.4 lbs.



**Art. 140/1/3**  
Mtl 5/32"  
H 2 11/16"  
Wt. 0.9 lbs



**Art. 719/1**  
Mtl 9/16"  
W 20 1/4" x H 26 3/8"  
Wt. 15 lbs.



**Art. 720/2**  
Mtl 1/2" x 1/4"  
16 11/32" dia.  
Wt. 5.7 lbs.



Shown: 679/1, 685/4



**Art. 685/4**  
Mtl 1/2" dia.  
W 9 7/16" x H 23 1/4"  
Wt. 5 lbs.

**Art. 679/1**  
Mtl 1/2" dia.  
W 18" x H 18"  
Wt. 7.6 lbs.



**Art. 679/3**  
Mtl 1/2" dia.  
W 24 13/16"  
H 24 13/16"  
Wt. 12.14 lbs.



**Art. 480/1**  
Mtl 1/2" sq.  
W 26" x H 26"  
Wt. 23 lbs.



**Art. 719/2**  
Mtl 5/8" x 5/16"  
W 25 3/16" x H 27 15/16"  
Wt. 15.8 lbs.  
single sides

Shown:26/C/1





**SNAP-ONS**

Quick Reference # 7 2011



## Unbreakable Snap-Ons for 1/2" bar or tube

Steel snap-ons add elegance and style to even the simplest design. They will not break like cast iron. Also, the coatings or patinas apply equally to all of the steel components

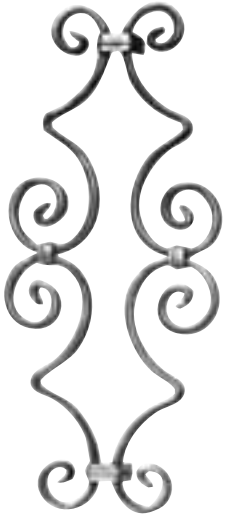

**Art. 35/1**  
Mtl 1/2" x 1/4"  
W 8 1/16" x H 17 1/2"  
Wt. 2.7 lbs.



**Art. 35/2**  
Mtl 1/2" x 1/4"  
W 7 7/8" x H 13 9/16"  
Wt. 2.1 lbs.

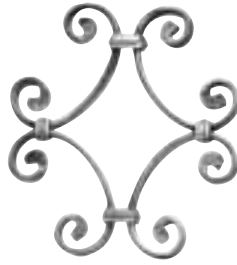

**Art. 36/1**  
Mtl 1/2" x 1/4"  
W 8 11/16" x H 9 27/32"  
Wt. 1.7 lbs.



**Art. 36/2**  
Mtl 1/2" x 1/4"  
W 9 1/16" x H 15"  
Wt. 2.8 lbs.



**Art. 37/3**  
Mtl 1/2" x 1/4"  
W 3 3/4" x H 3 3/4"  
Wt. 0.6 lbs.

Shown: 36/2, 36/1

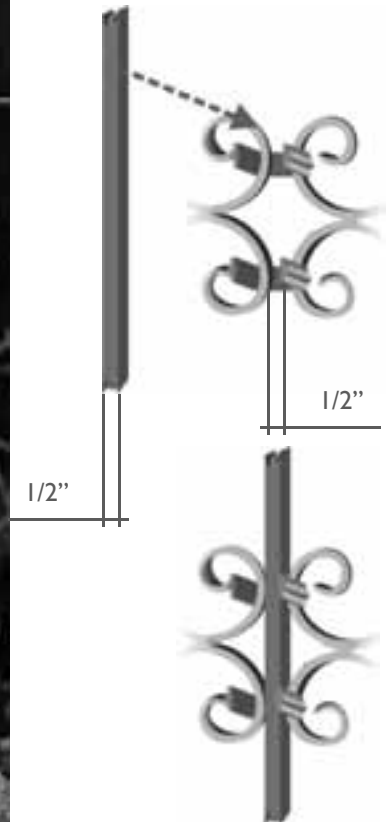



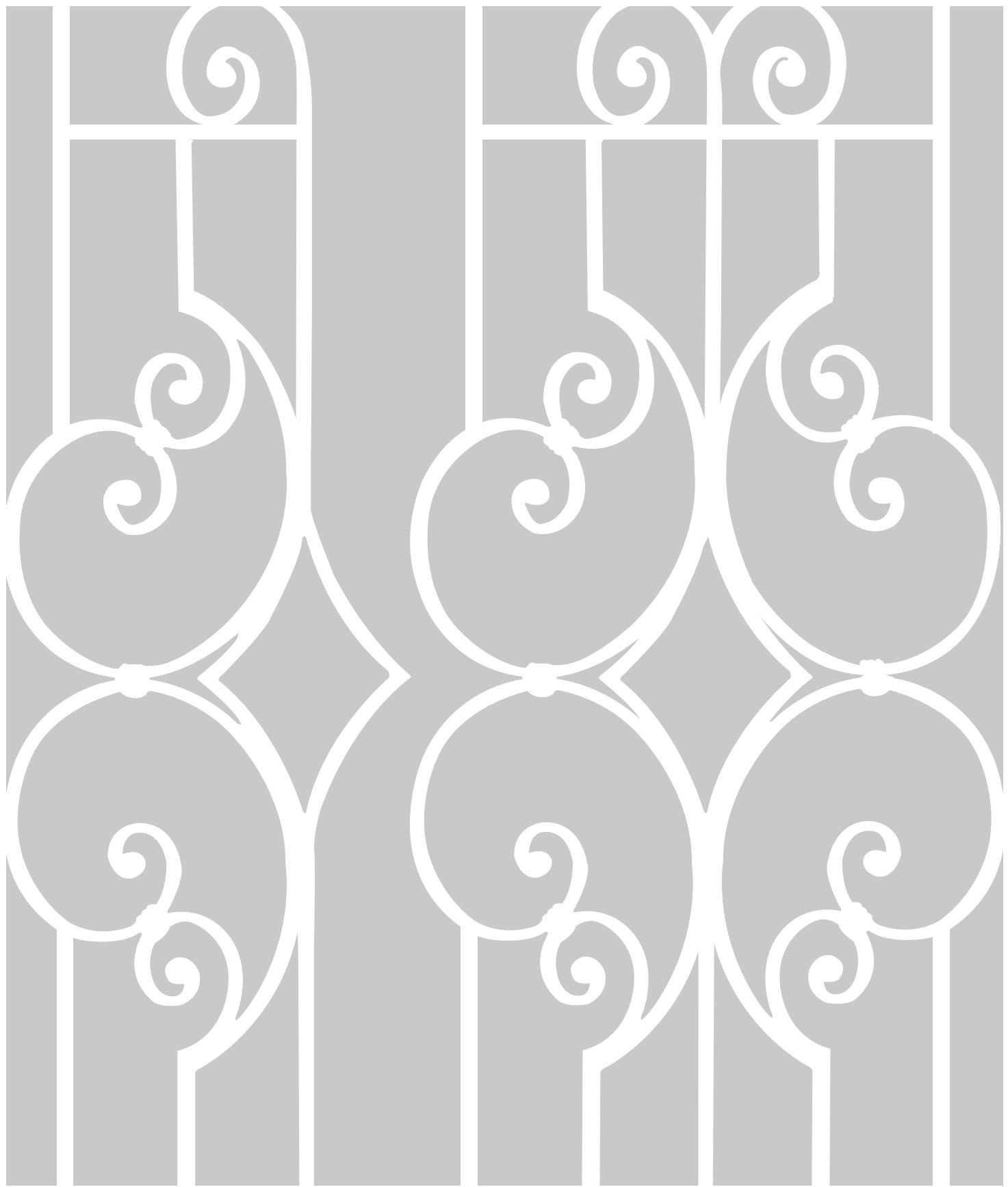

## PANELS

Quick Reference # 7 2011



New Items **New Items**

Shown: GD150/2



ARTEFERRO

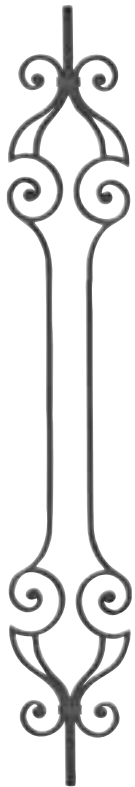

Art. GD150/2  
Mtl 9/16" sq.  
W 8 3/32" x H 39 3/8"  
Wt. 8.8 lbs.



Art. GD150/3  
Mtl 9/16" sq.  
W 7 1/2" x H 39 3/8"  
Wt. 8.14 lbs.



Art. GD151/1  
Mtl 9/16" sq.  
W 8 3/32" x H 39 3/8"  
Wt. 8.5 lbs.

Art. GD76/1  
Mtl 1" sq.  
W 19 11/16" x H 39 3/8"  
Wt. 23.1 lbs.

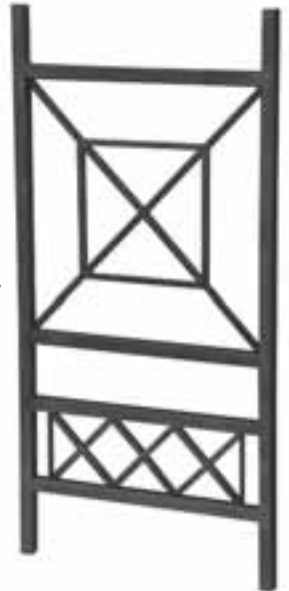

Art. GD76/2  
Mtl 1" sq.  
W 19 11/16" x H 27 9/16"  
Wt. 15.4 lbs.

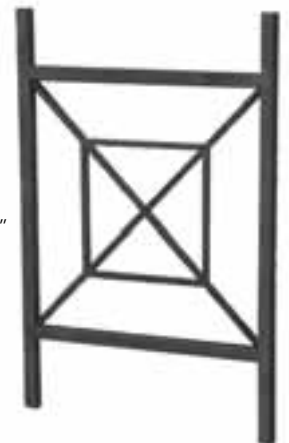

New Items **New Items**

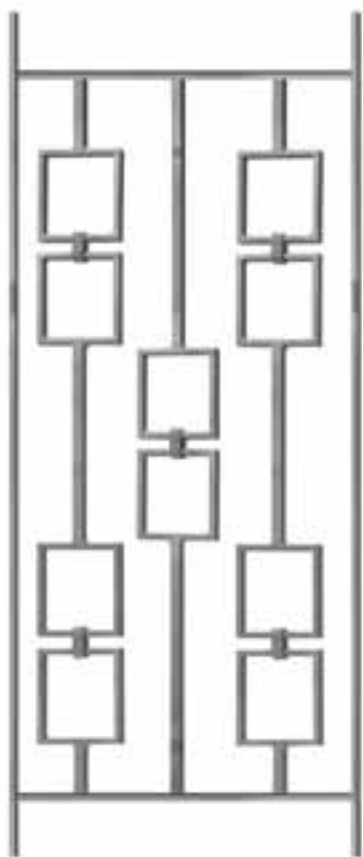

**Art. GD183/1**  
Mtl 9/16" x 5/16" sq.  
W 15 3/4" x H 39 3/8"  
Wt. 17.38 lbs.



**Art. GD184/1**  
Mtl 9/16" sq.  
W 4 17/32" x H 39 3/8"  
Wt. 5.10 lbs.



**Art. GD184/2**  
Mtl 9/16" sq.  
W 4 17/32" x H 39 3/8"  
Wt. 6.02 lbs.

Shown: GD 84/1, GD184/2



Shown: GD99/1



Art. GD99/1  
 Mtl 5/8" x 5/16"  
 W 16 9/16" x H 39 3/8"  
 Wt. 22.9 lbs



Art. GD175/7  
 Mtl 9/16" x 5/16"  
 W 7 7/8" x H 39 3/8"  
 Wt. 8.4 lbs



Art. GD245/1  
 Mtl 9/16" x 5/16"  
 W 13" x H 39 3/8"  
 Wt. 13.6 lbs



Art. GD245/2  
 Mtl 9/16" x 5/16"  
 W 13" x H 39 3/8"  
 Wt. 14.3 lbs



Tree bark effect -  
Art. 599/2

**Art. 485/1**  
Mtl 3/8" dia.  
W 14 9/16" x H 35 7/16"  
Wt. 11.24 lbs

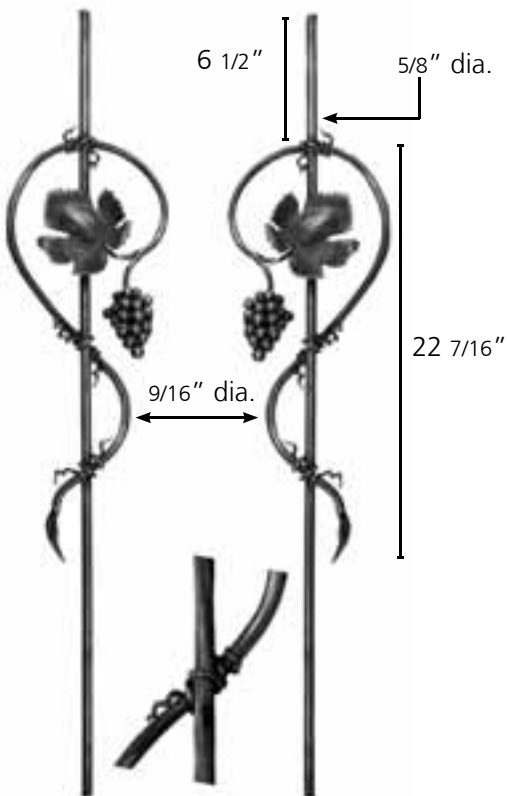

**Art. GD0039 left Art. GD0040 right**  
Mtl 5/8" dia.  
W 8 11/16" x H 45 1/4"  
Wt. 8.0 lbs.



**Art. 1670/2**  
Mtl 1/2" x 1/4"  
W 13 25/32" x H 34 1/4"  
Wt. 7.3 lbs



**Art. 1671/6**  
Mtl 1/2" x 1/4"  
W 7 11/16" x H 17 1/8"  
Wt. 2.7 lbs





Art. GD0042  
Mtl 5/8" sq.  
W 59 13/16" x H 33 7/8"  
Wt. 47.62 lbs.



Shown: GD0041

ARTEFERRO



Art. GD0045  
Mtl 9/16" dia.  
W 10" x H 34 5/8"  
Wt. 10.80 lbs.



Art. GD0046  
Mtl 9/16" dia.  
W 10" x H 31 7/8"  
Wt. 9.90 lbs.



Art. GD0041  
Mtl 5/8" sq.  
W 47 1/4" x H 33 7/8"  
Wt. 42.64 lbs.



Shown: GD0041

ARTEFERRO



**Art. GD0044**  
 Mtl 5/8" x 5/16" sq.  
 W 26" x H 29 15/16"  
 Wt. 21.10 lbs.



**Art. GD0043**  
 Mtl 5/8" x 5/16"  
 H 37 13/16"  
 W 11 13/16"  
 Wt. 9.41 lbs.



**Art. GD0047**  
 Mtl 5/8" x 5/16"  
 H 41 3/4"  
 W 11 13/16"  
 Wt. 10.18 lbs.

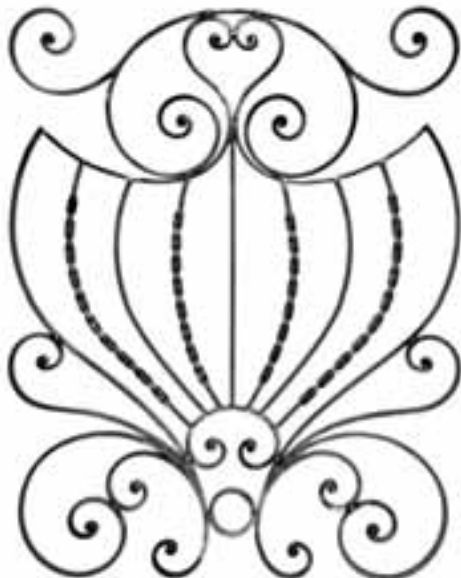

**Art. GD0038**  
 Mtl 5/8" x 5/16" sq.  
 W 27 15/16"  
 H 35 7/16"  
 Wt. 27.56 lbs.



**Art. GD0036**  
 Mtl 5/8" x 5/16" sq.  
 W 12 3/16"  
 H 31 7/8"  
 Wt. 9.66 lbs.



**Art. GD0037**  
 Mtl 5/8" x 5/16" sq.  
 W 27 15/16"  
 H 49 5/8"  
 Wt. 28.50 lbs.

Shown: 464/2



**Art. 464/1**  
Mtl 1/2" sq.  
W 9 1/16" x H 35 7/16"  
Wt. 7.2 lbs.



Basket Art. 159/3



**Art. 464/2**  
Mtl 1/2" sq.  
W 9 1/16" x H 35 7/16"  
Wt. 6.7 lbs.



**Art. 464/3**  
Mtl 1/2" sq.  
W 9 1/16" x H 35 7/16"  
Wt. 7.2 lbs.

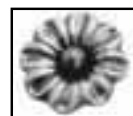

Flower Art. 697/4



**Art. 464/4**  
Mtl 1/2" sq.  
W 9 1/16" x H 35 7/16"  
Wt. 6.7 lbs.



**Art. GD39/1**  
Mtl 1/2" dia.  
W 7 7/8" x H 39 3/8"  
Wt. 6.3 lbs.

**Art. GD39/2**  
Mtl 1/2" dia.  
W 2 23/64" x H 39 3/8"  
Wt. 5.6 lbs.



**Art. GD39/3**  
Mtl 1/2" dia.  
W 7 1/2" x H 39 3/8"  
Wt. 5.13 lbs.

**Art. GD41/2**  
Mtl 1/2" dia.  
W 5 1/8" x H 39 3/8"  
Wt. 5.1 lbs.

Shown:GD41/2

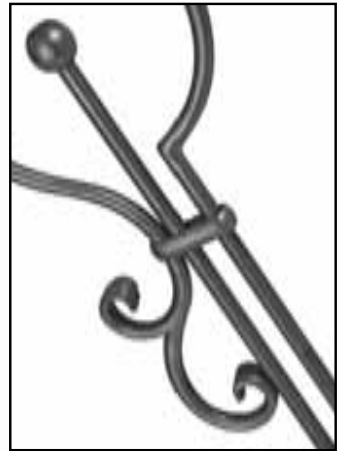

Hollow spheres 1 3/16" dia.

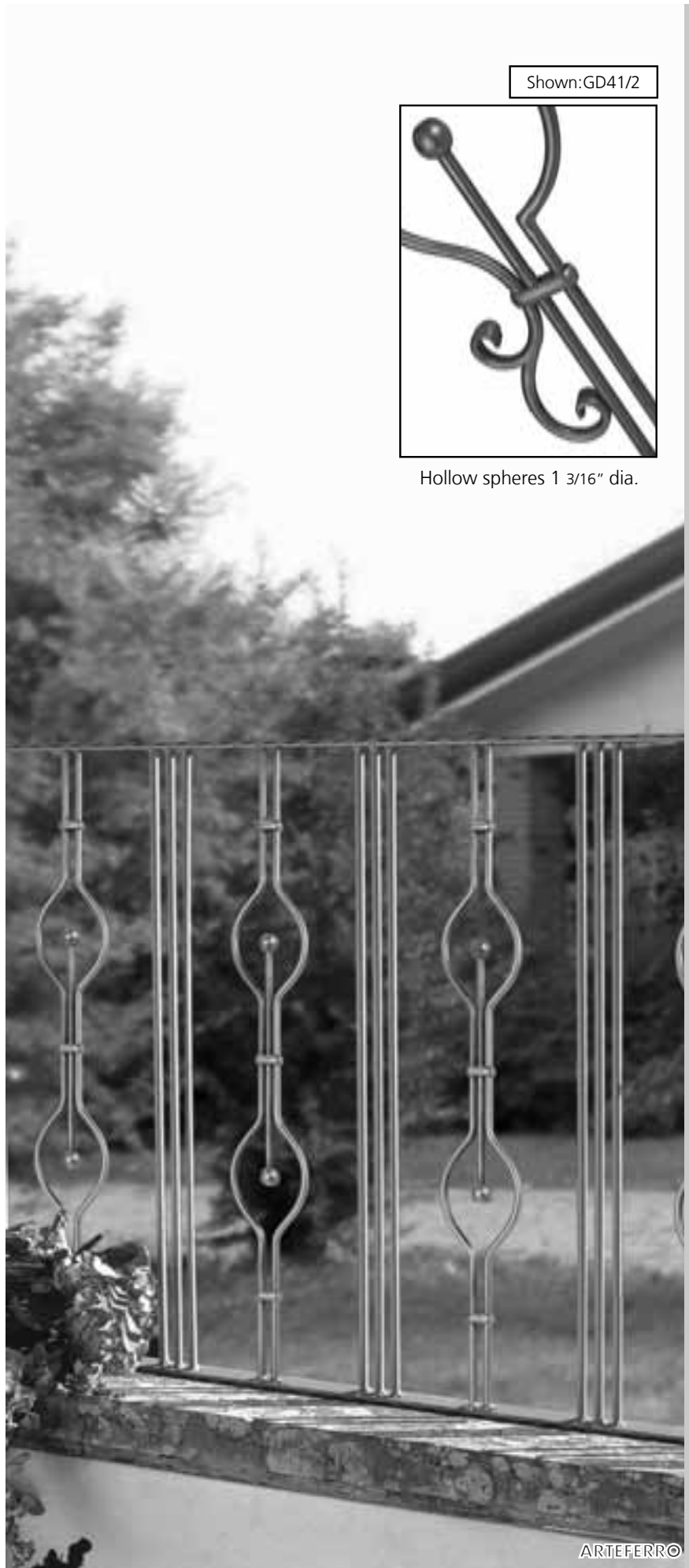

Shown:1670/1

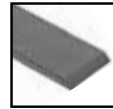
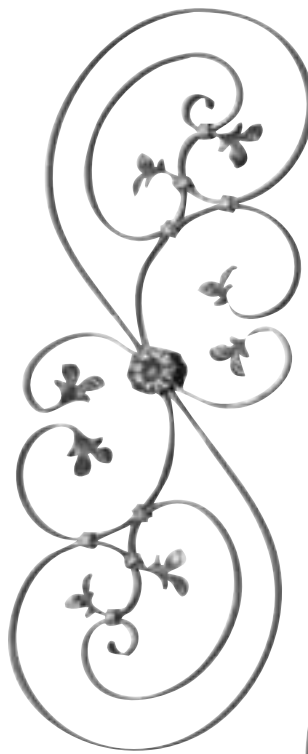

Plain

Art. 1670/1  
(ex 8021/1)  
Mtl 1/2" x 1/4"  
W 14 3/16"  
H 39 3/8"  
Wt. 8.4 lbs.

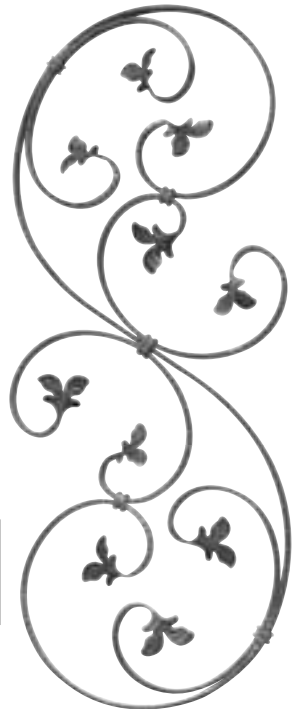

Hammered

Art. 1671/3  
(ex 8021/3)  
Mtl 1/2" x 1/4"  
W 13 25/32"  
H 34 1/4"  
Wt. 7.3 lbs.

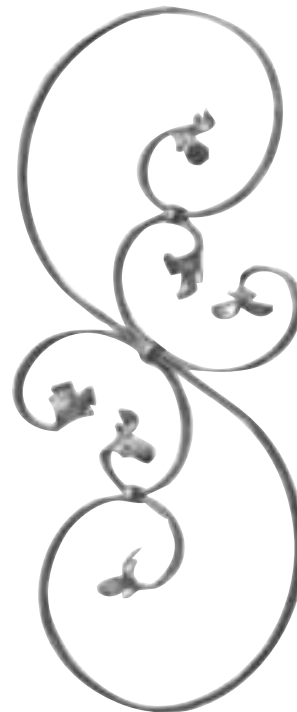

Plain

Art. 52/1  
Mtl 1/2" x 1/4"  
W 13 3/4"  
H 34 1/4"  
Wt. 5.5 lbs.





Plain

**Art. 541/2**  
 Mtl 9/16" dia.  
 W 13 13/32"  
 H 35 7/16"  
 Wt. 11 lbs.



**Art. 1051/5**  
 Mtl 1/2"x 1/4"  
 W 7 9/32"  
 H 23 5/8"  
 Wt. 3.52 lbs.



**Art. 1051/4**  
 Mtl 1/2"x 1/4"  
 W 5 29/32"  
 H 15 3/4"  
 Wt. 2.2 lbs.



Shown: 541/2

Ornate Floral Panels



**Art. 685/3**  
 Mtl 1/2" dia.  
 W 9 15/32"  
 H 23 1/4"  
 Wt. 5 lbs.



**Art. 685/4**  
 Mtl 1/2" dia.  
 W 9 15/32"  
 H 23 1/4"  
 Wt. 5 lbs.



**Art. 685/5**  
 Mtl 1/2" dia.  
 W 14 3/16"  
 H 31 29/32"  
 Wt. 9.02 lbs.



**Art. 685/6**  
 Mtl 1/2" dia.  
 W 14 3/16"  
 H 31 29/32"  
 Wt. 9.02 lbs.



**Art. 681/1**  
 Mtl 5/8" x 5/16"  
 W 10 5/8"  
 H 23 5/8"  
 Wt. 7.2 lbs.  
 Grooved



**Art. 681/2**  
 Mtl 5/8" x 5/16"  
 W 10 5/8"  
 H 23 5/8"  
 Wt. 7.2 lbs.  
 Grooved



**Art. 681/3**  
 Mtl 5/8" x 5/16"  
 W 12 19/32"  
 H 29 1/8"  
 Wt. 11 lbs.  
 Grooved



**Art. 681/4**  
 Mtl 5/8" x 5/16"  
 W 12 19/32"  
 H 29 1/8"  
 Wt. 11 lbs.  
 Grooved



**Art. 687/3**  
Mtl 1/2" dia.  
W 4 3/4" x H 6 11/16"  
Wt. 1.3 lbs.  
Grooved



**Art. 687/6**  
Mtl 1/2" dia.  
W 4 3/4" x H 6 11/16"  
Wt. 1.3 lbs.  
Grooved



**Art. 682/10**  
Mtl 5/8" x 5/16"  
W 11 13/16" x H 15 3/4"  
Wt. 3.3 lbs.  
Grooved



**Art. 682/11**  
Mtl 5/8" x 5/16"  
W 11 13/16" x H 15 3/4"  
Wt. 3.3 lbs.  
Grooved



**Art. 681/7**  
Mtl 5/8" x 5/16"  
W 13" x H 16 5/16"  
Wt. 4.7 lbs.  
Grooved



**Art. 681/8**  
Mtl 5/8" x 5/16"  
W 13" x H 16 5/16"  
Wt. 4.7 lbs.  
Grooved



**Art. 681/5**  
Mtl 5/8" x 5/16"  
W 9 15/32" x H 11 13/16"  
Wt. 3 lbs.  
Grooved



**Art. 681/6**  
Mtl 5/8" x 5/16"  
W 9 15/32" x H 11 13/16"  
Wt. 3 lbs.  
Grooved



**Art. 682/1**  
Mtl 5/8" x 5/16"  
W 9 15/32" x H 18 1/8"  
Wt. 3.5 lbs.  
Grooved



**Art. 682/2**  
Mtl 5/8" x 5/16"  
W 9 15/32" x H 18 1/8"  
Wt. 3.5 lbs.  
Grooved



## Ornate Floral Panels



**Art. 94/C/11**  
Mtl 1/2" dia.  
W 13"  
H 14 5/16"  
Wt. 3.5 lbs.



**Art. 94/C/12**  
Mtl 1/2" dia.  
W 13"  
H 14 5/16"  
Wt. 3.5 lbs.

**Art. 94/E/3**  
Mtl 1/2" dia.  
W 12 7/32"  
H 21 1/4"  
Wt. 3 lbs.



**Art. 94/E/4**  
Mtl 1/2" dia.  
W 12 7/32"  
H 21 1/4"  
Wt. 3 lbs.



**Art. 94/E/1**  
Mtl 1/2" dia.  
W 17 5/16"  
H 18 1/8"  
Wt. 4.9 lbs.



**Art. 94/E/2**  
Mtl 1/2" dia.  
17 5/16" W x  
18 1/8" H  
Wt. 4.9 lbs.

**Art. 94/E/5**  
Mtl 1/2" dia.  
W 16 5/32"  
H 24 13/32"  
Wt. 4.4 lbs.



**Art. 94/E/6**  
Mtl 1/2" dia.  
W 16 5/32"  
H 24 13/32"  
Wt. 4.4 lbs.

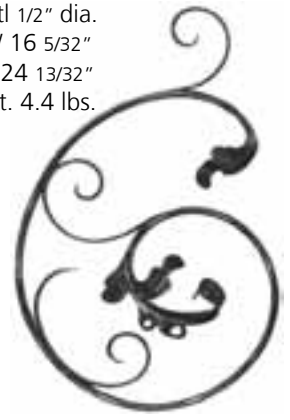

Shown: 94/C/12, 94/E/3



Shown: 94/C/12, 94/E/3



**Art. 94/F/1**  
Mtl 1/2" dia.  
W 12 19/32"  
H 27 3/16"  
Wt. 3.8 lbs.



**Art. 94/F/2**  
Mtl 1/2" dia.  
W 12 19/32"  
H 27 3/16"  
Wt. 3.8 lbs.



**Art. 94/F/3**  
Mtl 1/2" dia.  
W 19 5/16"  
H 31 1/2"  
Wt. 5.5 lbs.



**Art. 94/F/4**  
Mtl 1/2" dia.  
W 19 5/16"  
H 31 1/2"  
Wt. 5.5 lbs.



**Art. 94/F/5**  
Mtl 1/2" dia.  
W 16 17/32"  
H 38 3/16"  
Wt. 6.1 lbs.



**Art. 94/F/6**  
Mtl 1/2" dia.  
W 16 17/32"  
H 38 3/16"  
Wt. 6.1 lbs.





# Stair and Rail Panels



Art. 1046/1  
Mtl 1/2" sq.  
W 9 27/32"  
H 35 7/16"  
Wt. 9.2 lbs.



Art. 1046/2  
Mtl 1/2" sq.  
W 7 7/8"  
H 35 7/16"  
Wt. 6.6 lbs.



Art. 1043/1  
Mtl 1/2" sq.  
W 8 9/32"  
H 40 9/16"  
Wt. 7.7 lbs.

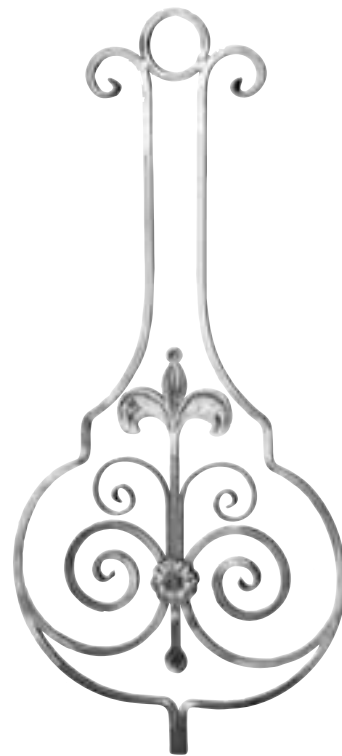

Art. 1043/2  
Mtl 1/2" sq.  
W 19 5/16"  
H 40 9/16"  
Wt. 15 lbs.

Shown: 1046/2



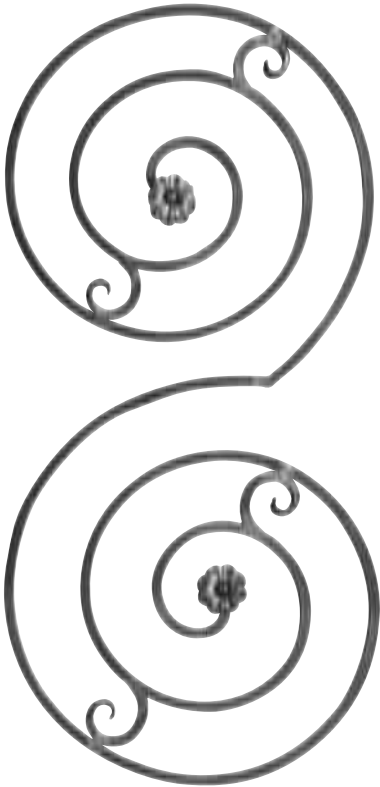

Art. 1038/1  
Mtl 9/16"  
W 20 25/32"  
H 42 1/2"  
Plain  
Wt. 18.7 lbs.



Art. 1039/1  
Mtl 9/16" sq  
W 22 7/16"  
H 30"  
Wt. 18.7 lbs.



Art. 1038/2  
Mtl 9/16" sq  
W 22 25/32"  
H 22 1/32"  
Plain  
Wt. 9.2 lbs.



Shown: 1038/1, 1038/2, 1039/1

Large Panels



Art. 715/1  
Mtl 1/2" dia.  
W 22 7/8"  
H 34 5/8"  
Hammered  
Wt. 14.0 lbs.



Art. 715/2  
Mtl 1/2" dia.  
W 22 7/8"  
H 34 5/8"  
Hammered  
Wt. 14.0 lbs.

Shown: 715/1, 715/2



Shown: GD61/1. GD23/1



Art. GD61/1  
Mtl 1/2" sq.  
W 16 7/8"  
H 39 3/8"  
Wt. 23.8 lbs.



Art. GD212/1  
Mtl 1/2" sq.  
W 16 1/2"  
H 39 3/8"  
Wt. 21.6 lbs.



Shown: GD255/1



ARTEFERRO

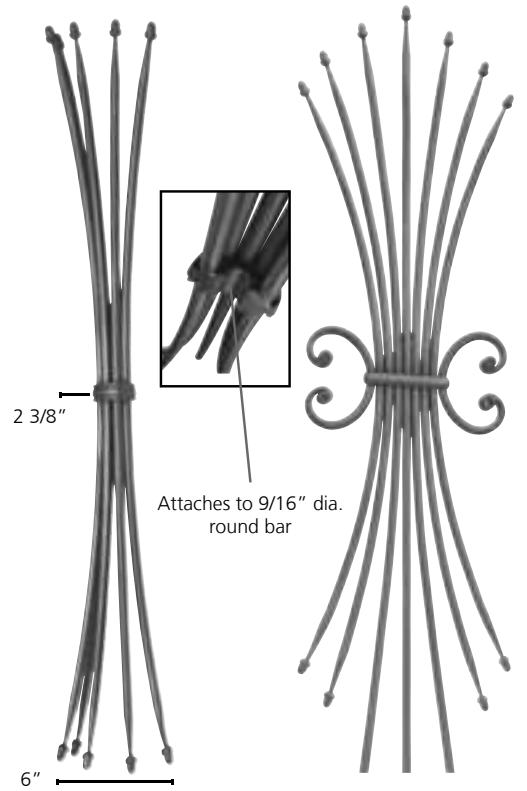

Art. GD253/1  
Mtl 1/2" dia.  
W 6"  
H 39 3/8"  
Wt. 8.2 lbs.

Art. GD255/1  
Mtl 1/2" dia.  
W 11 7/16"  
H 39 3/8"  
Wt. 13.6 lbs.

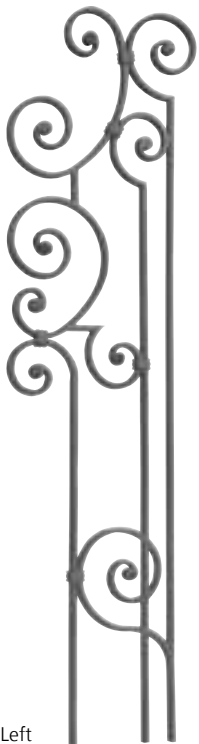

Left

Art. GD163/2  
Mtl 9/16" x 5/16"  
11 1/32" W x  
39 3/8" H  
Wt. 10.3 lbs.



Right

Art. GD163/1  
Mtl 9/16" x 5/16"  
11 1/32" W x  
39 3/8" H  
Wt. 10.3 lbs.



Art. GD159/1  
Mtl 9/16" x 5/16"  
W 11 1/32"  
H 39 3/8"  
Wt. 8 lbs.

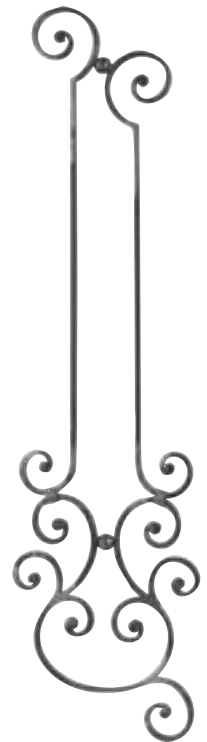

Art. GD159/2  
Mtl 9/16" x 5/16"  
W 11 1/32"  
H 39 3/8"  
Wt. 6.2 lbs.



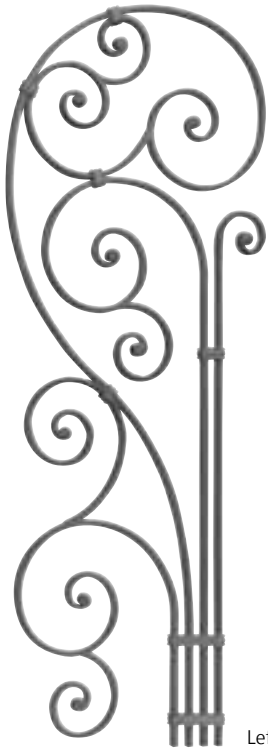

Left

Art. GD164/1  
Mtl 9/16" x 5/16"  
W 15"  
H 39 3/8"  
Wt. 14.1 lbs.

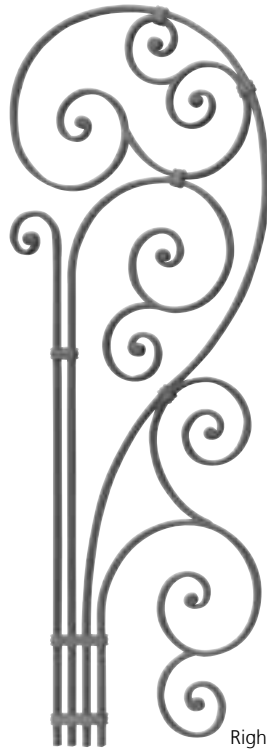

Right

Art. GD164/2  
Mtl 9/16" x 5/16"  
W 15"  
H 39 3/8"  
Wt. 14.1 lbs.



Art. GD222/2  
Mtl 9/16" x 5/16"  
W 19 11/16"  
H 39 3/8"  
Wt. 21 lbs.



Art. GD223/1  
Mtl 9/16" x 5/16"  
W 10 13/16"  
H 39 3/8"  
Wt. 12.3 lbs.

Shown: GD164/1 - GD164/2



Large Panels

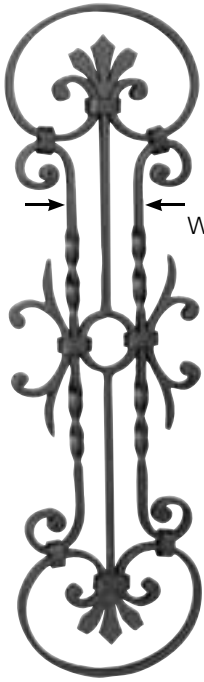

W 3 3/8" approx.

Art. GD0014  
Mtl 5/8" x 5/16"  
W 8 3/4" approx.  
H 29 15/16" approx.  
Wt. 9.9 lbs.

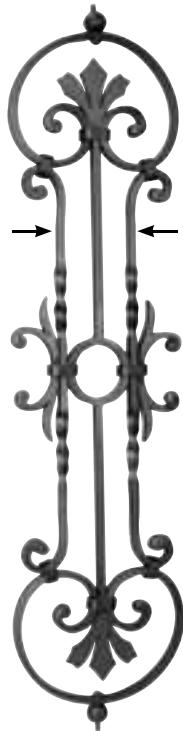

W 2 3/4" approx.

Art. GD0013  
Mtl 5/8" x 5/16"  
W 10 3/16" approx.  
H 37 7/16" approx.  
Wt. 16.5 lbs.



Art. GD009  
Mtl 5/8" x 5/16"  
W 9 9/16" approx.  
H 29 5/16" approx.  
Wt. 12.6 lbs.

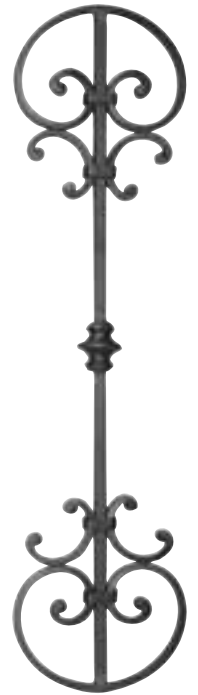

Art. GD008  
Mtl 5/8" x 5/16"  
W 9 9/16" approx.  
H 37 7/16" approx.  
Wt. 12.1 lbs.



Shown: GD0013, GD0029

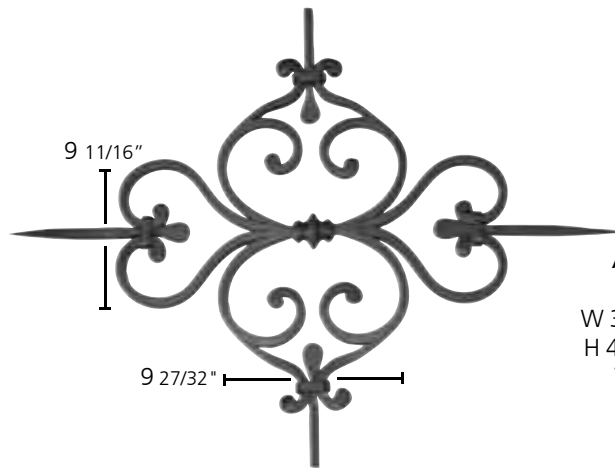

9 11/16"

9 27/32"

Art. GD0011  
Mtl 5/8" sq.  
W 31 57/64" approx.  
H 41 11/32" approx.  
Wt. 24.7 lbs.

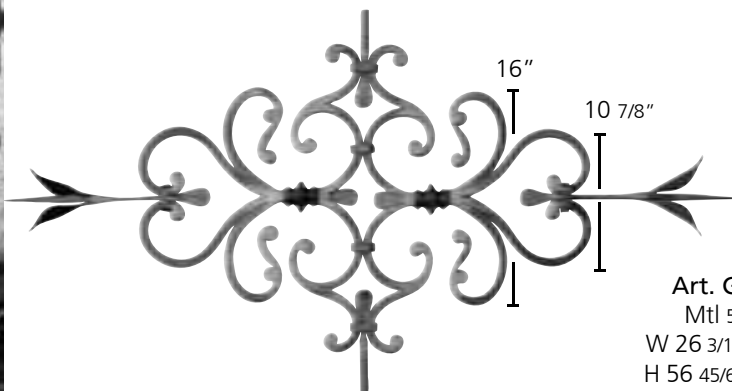

16"

10 7/8"

Art. GD0010  
Mtl 5/8" sq.  
W 26 3/16" approx.  
H 56 45/64" approx.  
Wt. 36.8 lbs.

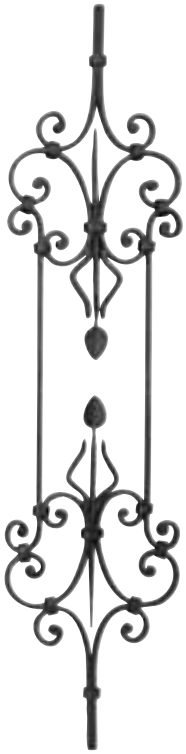

Art. GD0015  
Mtl 1/2" x 1/4"  
W 9 9/16" approx.  
H 39 3/8" approx.  
Wt. 7.5 lbs.

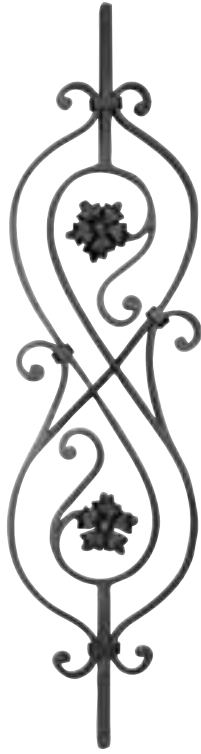

Art. GD0016  
Mtl 5/8" x 5/16"  
W 10 5/8" approx.  
H 39 3/8" approx.  
Wt. 12.3 lbs.

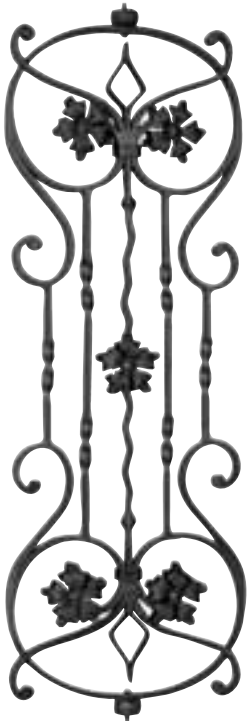

Art. GD0017  
Mtl 5/8" x 5/16"  
W 12 63/63" approx.  
H 37 13/64" approx.  
Wt. 16.7 lbs.

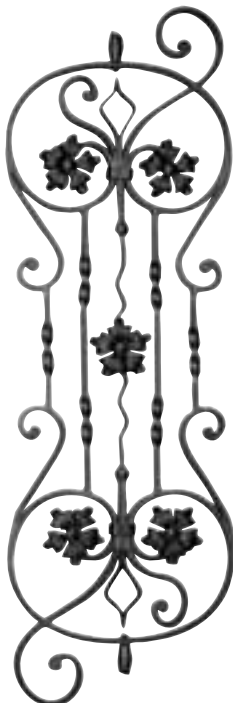

Art. GD0018  
Mtl 5/8" x 5/16"  
W 12 63/63" approx.  
H 36 7/32" approx.  
Wt. 17 lbs.



Shown: GD0012

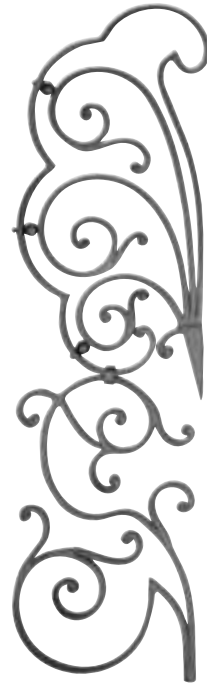

**Art. GD0020**  
Mtl 5/8" x 5/16"  
W 12 39/64" approx.  
H 44 7/8" approx.  
Wt. 21.2 lbs.



**Art. GD003**  
Mtl 5/8" x 5/16"  
W 28 11/32" approx.  
H 23 3/64" approx.  
Wt. 18.5 lbs.



**Art. GD0012**  
Mtl 5/8" x 5/16"  
W 24 1/64" approx.  
H 36 39/64" approx.  
Wt. 36.8 lbs.

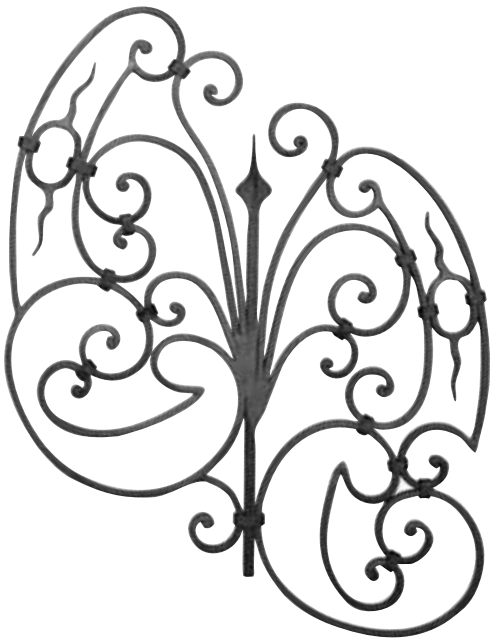

Art. GD007  
Mtl 5/8" x 5/16"  
W 28 47/64" approx.  
H 30 5/16" approx.  
Wt. 34.2 lbs.

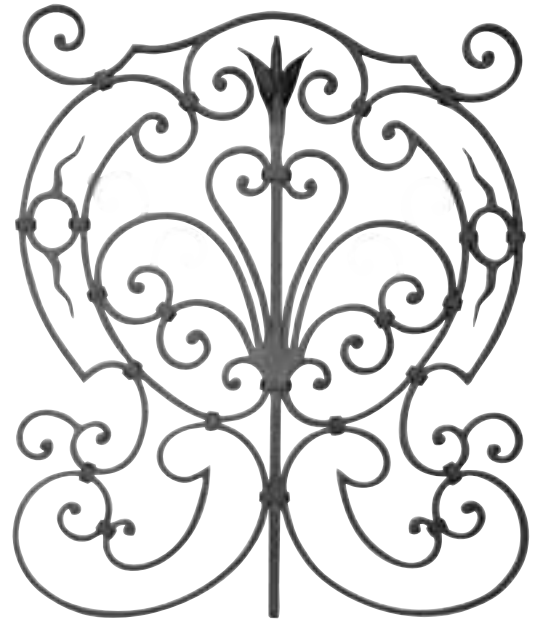

Art. GD006  
Mtl 5/8" x 5/16"  
W 31 1/2" approx.  
H 37 7/16" approx.  
Wt. 47 lbs.



Art. GD0019  
Mtl 5/8" x 5/16"  
W 25 13/64" approx.  
H 37 7/16" approx.  
Wt. 37.5 lbs.



Shown: GD007



# Large Panels

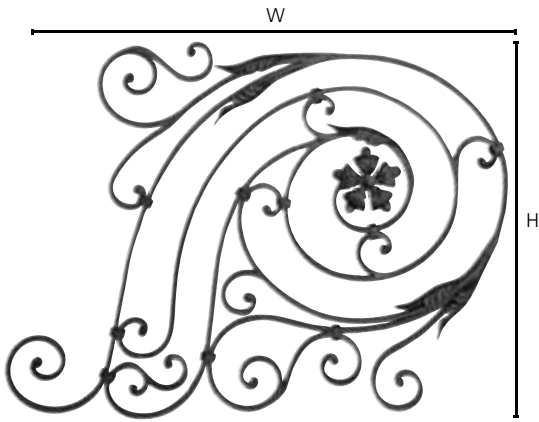

**Art. GD004**  
 Mtl 5/8" x 5/16"  
 W 30 5/16" approx.  
 H 40 35/64" approx.  
 Wt. 35.8 lbs.

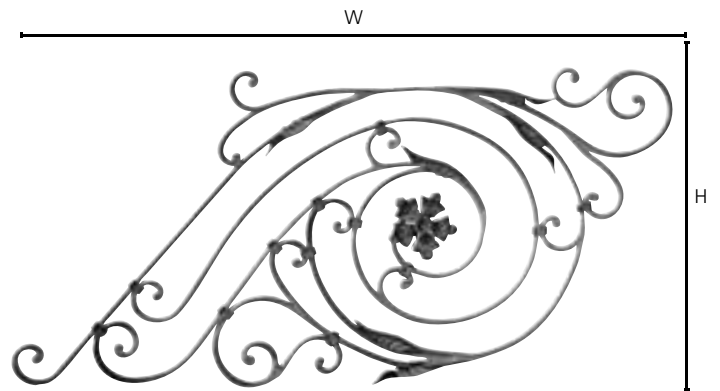

**Art. GD005**  
 Mtl 5/8" x 5/16"  
 W 55 21/64" approx.  
 H 26 3/8" approx.  
 Wt. 34 lbs.

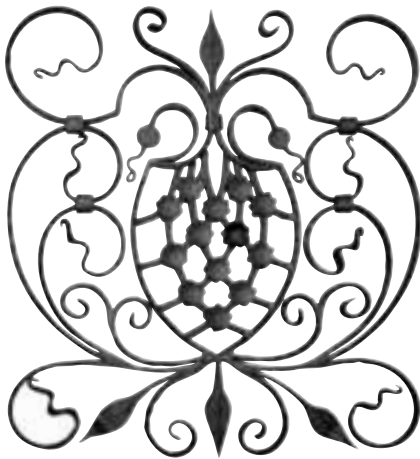

**Art. GD001**  
 Mtl 1" x 5/16"  
 W 31 1/2" approx.  
 H 33 15/32" approx.  
 Wt. 48.1 lbs.

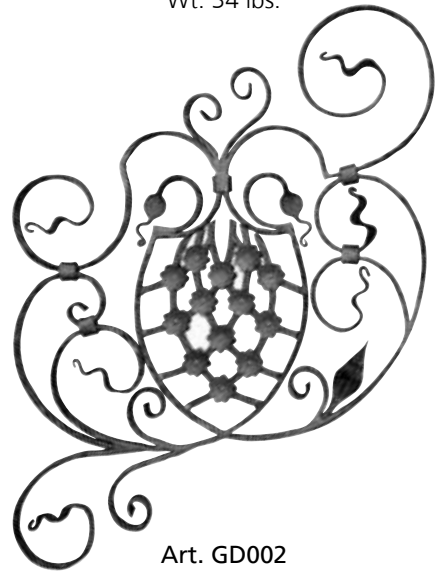

**Art. GD002**  
 Mtl 1" x 5/16"  
 W 31 7/64" approx.  
 H 30 5/16" approx.  
 Wt. 40.8 lbs.

Shown: GD001





**Art. GD0033**  
Mtl 5/8" x 3/8"  
W 3 15/16" approx.  
H 5 1/8" approx.  
Wt. 0.8 lbs.



**Art. GD0022/SX**  
Mtl 3/4" x 3/8"  
W 3 15/16" approx.  
H 9 9/16" approx.  
Wt. 1.5 lbs.



**Art. GD0022/DX**  
Mtl 3/4" x 3/8"  
3 15/16" W approx.  
x 9 9/16" H approx.  
Wt. 1.5 lbs.



**Art. GD0034**  
Mtl 5/8" x 3/8"  
W 12 1/4" approx.  
H 9 7/16" approx.  
Wt. 1.9 lbs.



**Art. GD0032**  
Mtl 5/8" x 3/8"  
W 9 1/16" approx.  
H 6 11/16" approx.  
Wt. 2.4 lbs.

**Art. GD0023/SX**  
Mtl 5/8" x 3/8"  
W 3 15/16" approx.  
H 9 9/16" approx.  
Wt. 1.2 lbs.

**Art. GD0023/DX**  
Mtl 5/8" x 3/8"  
3 15/16" W approx.  
x 9 9/16" H approx.  
Wt. 1.2 lbs.



**Art. GD0028**  
Mtl 5/8" x 3/8"  
W 3 15/16" approx.  
H 8 55/64" approx.  
Wt. 1.5 lbs.



**Art. GD0027**  
Mtl 5/8" x 3/8"  
W 3 15/16" approx.  
H 9 27/32" approx.  
Wt. 1.65 lbs.



**Art. GD0024**  
Mtl 5/8" x 3/8"  
W 3 15/16" approx.  
H 2 61/64" approx.  
Wt. 0.66 lbs.



**Art. GD0026**  
Mtl 5/8" x 3/8"  
W 8 55/64" approx.  
H 2 3/4" approx.  
Wt. 1.0 lbs.



**Art. GD0035**  
Mtl 5/8" x 3/8"  
W 1 9/16" approx.  
H 5 1/8" approx.  
Wt. 0.4 lbs.

**Art. GD0025**  
Mtl 5/8" x 3/8"  
W 3 15/16" approx.  
H 2 61/64" approx.  
Wt. 0.66 lbs.

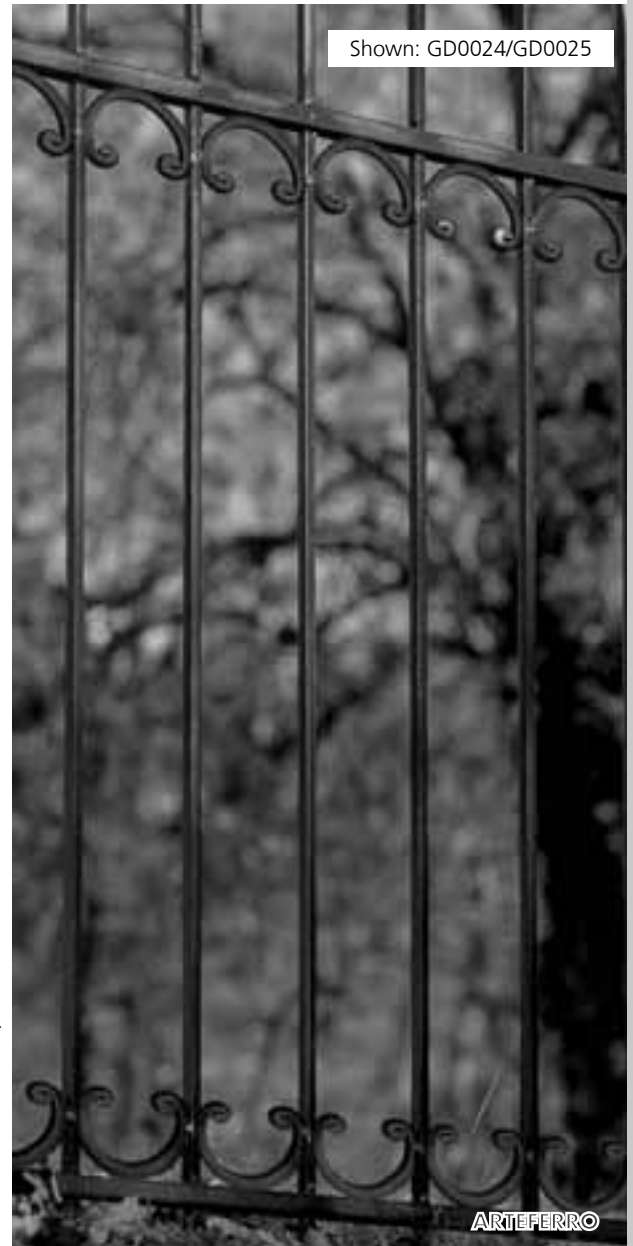

Shown: GD0024/GD0025

Stair and Rail Panels

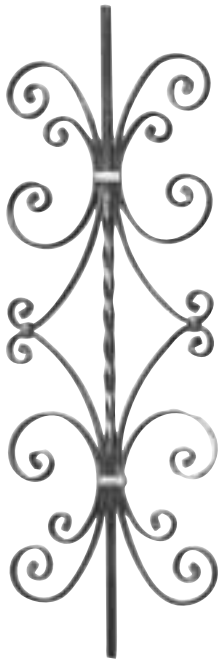

**Art. 51/3**  
Mtl 1/2" sq.  
W 11 13/16"  
H 35 7/16"  
Wt. 9.0 lbs.



**Art. 511/1**  
Mtl 1/2" sq.  
W 4 15/16"  
H 33 7/16"  
Wt. 5.4 lbs.



**Art. 103/2**  
Mtl 1/2" sq.  
W 6 1/2"  
H 33 7/16"  
Wt. 5.1 lbs.



**Art. 540/2**  
Mtl 1/2" dia.  
W 9 7/8"  
H 28 3/8"  
Wt. 5.0 lbs.



**Art. 62/1**  
Mtl 3/4" x 1/4"  
W 9 1/4"  
H 28 3/8"  
Wt. 5.2 lbs.

Shown: 479/2

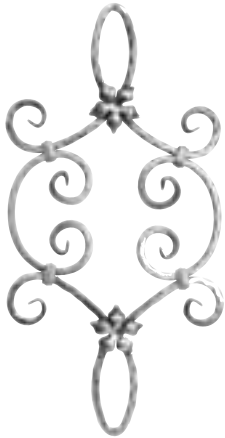

**Art. 474/1**

Mtl 1/2" sq

W 14 31/32" x H 29 23/32"

Hammered  
Wt. 10.6 lbs.



**Art. 475/1**

Mtl 1/2" sq.

W 15" x H 32 1/2"

Wt. 10 lbs.

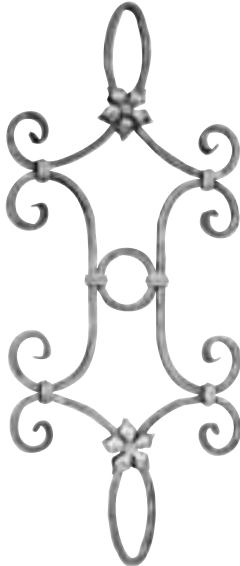

**Art. 479/2**

Mtl 1/2" sq.

W 15 1/8" x H 35 7/16"

Wt. 10 lbs.



**Art. 475/2**

Mtl 1/2" sq.

W 15"

H 35 7/16"

Wt. 12 lbs.



**Art. 476/1**

Mtl 1/2" sq.

W 15"

H 35 7/16"

Wt. 14 lbs.



**Art. 476/2**

Mtl 1/2" sq.

W 15"

H 32 7/16"

Wt. 11 lbs.



**Art. 478/1**

Mtl 1/2" sq.

W 15"

H 32 1/2"

Wt. 10 lbs.



**Art. 478/2**

Mtl 1/2" sq.

W 15"

H 35 7/16"

Wt. 12 lbs.



**Art. 479/1**

Mtl 1/2" sq

W 4 5/16"

H 35 7/16"

Plain

Wt. 3.0 lbs.



Shown: 1050/2

End scrolls are  
hot forged



**Art. 1050/2**

Mtl 3/8" sq.

W 9 5/8"

H 28 3/8"

Wt. 3.7 lbs.



**Art. 1050/3**

Mtl 9/16" sq.

W 10 7/16"

H 28 3/8"

Wt. 4.4 lbs.



GLASS

**Art. 478/3**

3 5/16" dia.

Wt. .4 lbs



WOOD

**Art. 745/1**

3 7/8" dia.

Wt. .13 lbs



BRASS

**Art. 160/H/N**

3 7/8" dia.

Wt. .72 lbs

Brass, glass and wooden embellishments are recommended for inside use only.

# Rail Panels



**Art. 1142/1**  
Mtl 1/2" sq.  
W 7 3/32"  
H 39 3/8"  
Wt. 8.1 lbs.



**Art. 1142/2/S**  
Mtl 1/2" sq.  
W 11 1/32"  
H 39 3/8"  
Wt. 11.4 lbs.



**Art. 1115/1**  
Mtl 1/2" sq.  
W 4 1/8"  
H 39 3/8"  
Wt. 2.0 lbs.



**Art. 1115/2**  
Mtl 1/2" sq.  
W 4 1/8"  
H 39 3/8"  
Wt. 2.8 lbs.



**Art. 1111/1**  
Mtl 1/2" sq.  
W 9 7/16"  
H 39 3/8"  
Wt. 6.1 lbs.



**Art. 1111/2**  
Mtl 1/2" sq.  
W 8 1/16"  
H 39 3/8"  
Wt. 6.0 lbs.



**Art. 1118/1**  
Mtl 1/2"x 1/4"  
W 8 7/16"  
H 39 3/8"  
Wt. 4.0 lbs.

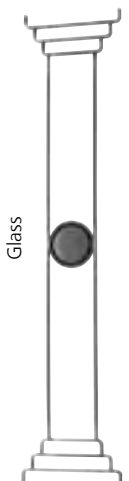

**Art. 1118/2**  
Mtl 1/2"x 1/4"  
W 8 7/16"  
H 39 3/8"  
Wt. 4.0 lbs.



Shown: 1685/1

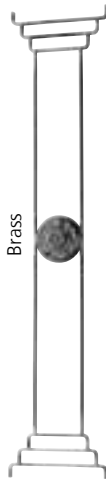

**Art. 1118/3**  
Mtl 1/2"x 1/4"  
W 8 7/16"  
H 39 3/8"  
Wt. 4.0 lbs.

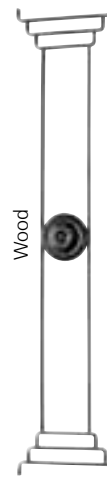

**Art. 1118/4**  
Mtl 1/2"x 1/4"  
W 8 7/16"  
H 39 3/8"  
Wt. 4.0 lbs.



**Art. 1097/1**  
Mtl 1/2" sq.  
W 12"  
H 39 3/8"  
Wt. 8.8 lbs.



**Art. 1097/3**  
Mtl 1/2" sq.  
W 4 1/8"  
H 39 3/8"  
Wt. 3.1 lbs.

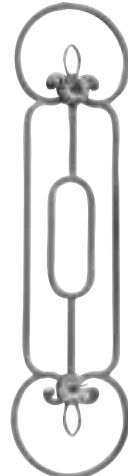

**Art. 1685/1**  
(ex 9133/1)  
Mtl 9/16" sq.  
H 39 3/8"  
Wt. 13.6 lbs.



**Art. 1685/2**  
(ex 9133/1)  
Mtl 9/16" sq.  
H 39 3/8"  
Wt. 13.6 lbs.

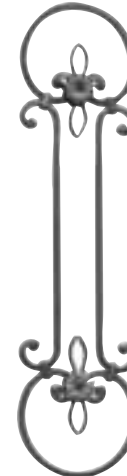

**Art. 1682/1**  
(ex 9133/3)  
Mtl 9/16" sq.  
H 39 3/8"  
Wt. 13.2 lbs.



**Art. 1682/2**  
(ex 9133/4)  
Mtl 9/16" sq.  
H 39 3/8"  
Wt. 7.7 lbs.



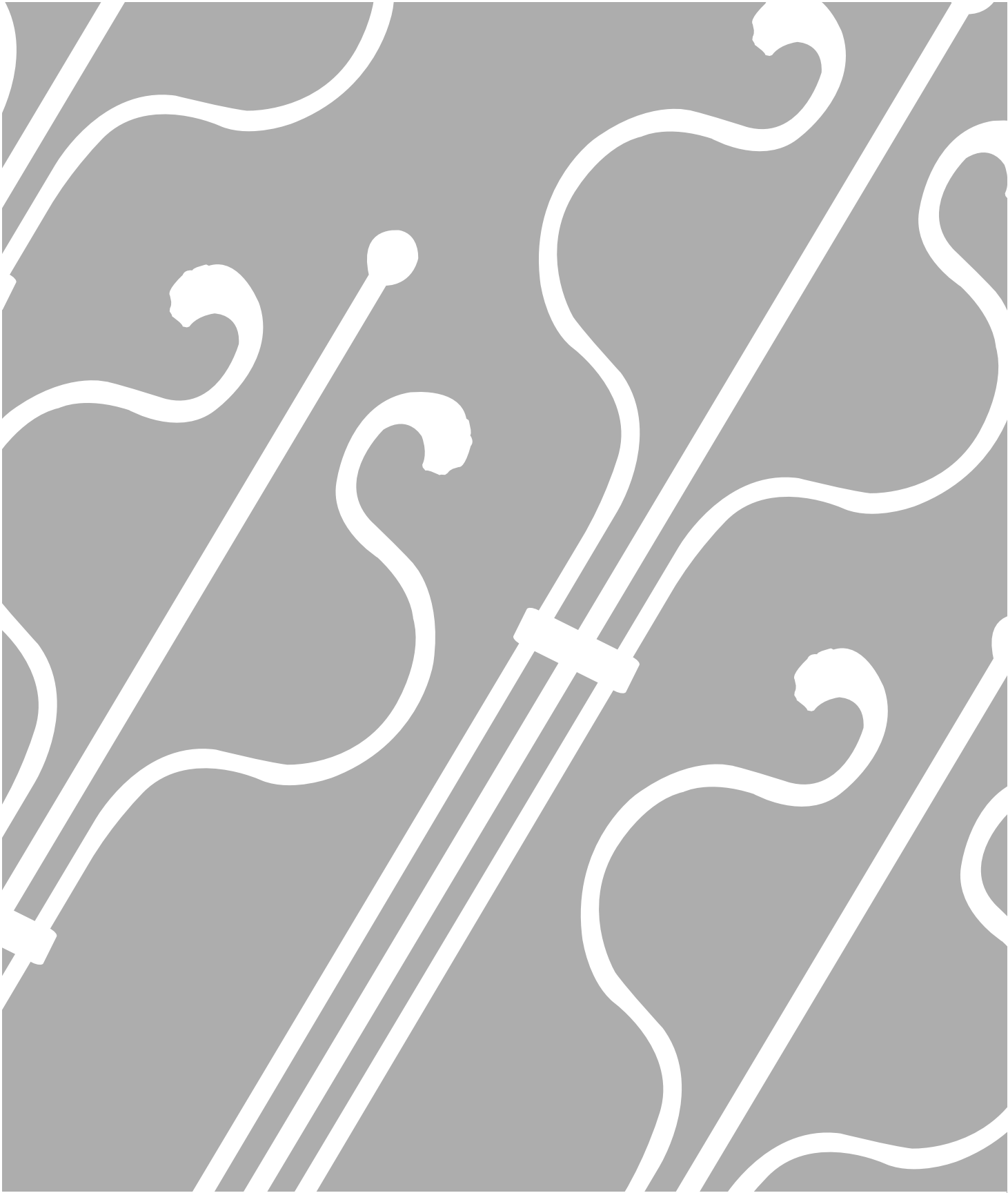

# PICKETS

Quick Reference # 7 2011

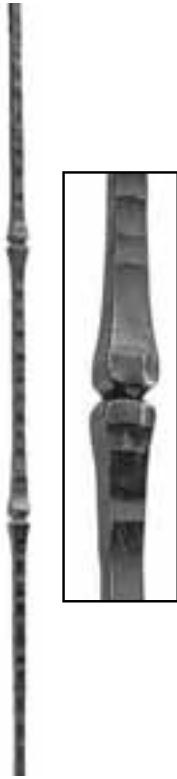

**Art. 1192/5**  
Mtl 3/8" sq.  
H 39 3/8"  
Wt. 2.42 lbs.



**Art. 1192/6**  
Mtl 3/8" sq.  
H 39 3/8"  
Wt. 2.2 lbs.



**Art. 1733/13**  
Mtl 1/2" sq.  
W 2 3/16"  
H 39 3/8"  
Wt. 2.64 lbs.



**Art. 1733/15**  
Mtl 1/2" sq.  
W 2 3/16"  
H 39 3/8"  
Wt. 2.75 lbs.



**Art. 490/2**  
Mtl 9/16" sq.  
H 39 3/8"  
Wt. 3.36 lbs.



**Art. 490/1**  
Mtl 9/16" sq.  
H 39 1/2"  
Wt. 2.2 lbs.

Shown: 489/2



**Art. 489/2**  
Mtl 1/2" sq.  
H 39 3/8"  
Wt. 3.37 lbs.



**Art. 489/1**  
Mtl 1/2" sq.  
H 39 3/8"  
Wt. 3.7 lbs.

# New Items

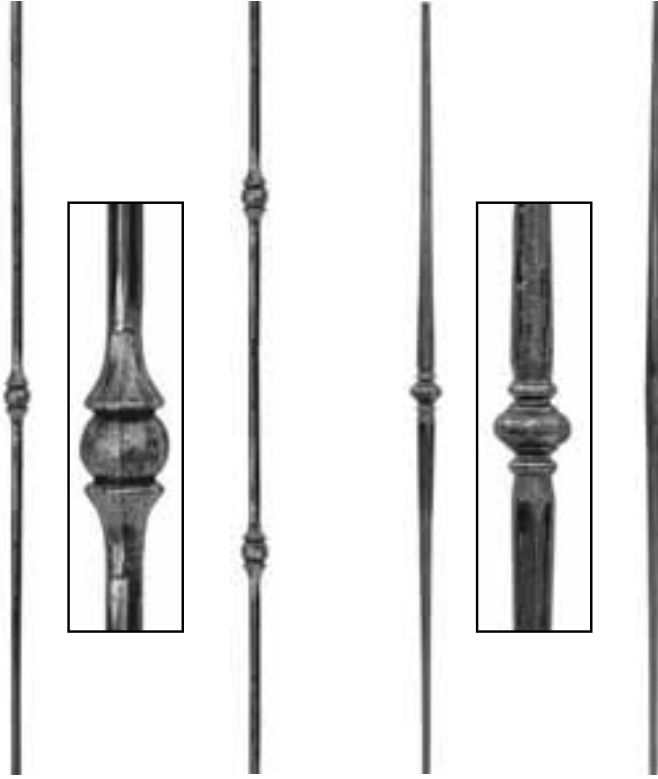

**Art. 1187/4**  
Mtl 9/16" dia.  
H 39 3/8"  
Wt. 3.08 lbs.

**Art. 1187/5**  
Mtl 9/16" dia.  
H 39 3/8"  
Wt. 3.4 lbs.

**Art. 1187/1**  
Mtl 1/2" dia.  
H 39 3/8"  
Wt. 4.4 lbs.

**Art. 1187/2**  
Mtl 1/2" dia.  
H 39 3/8"  
Wt. 3.52 lbs.

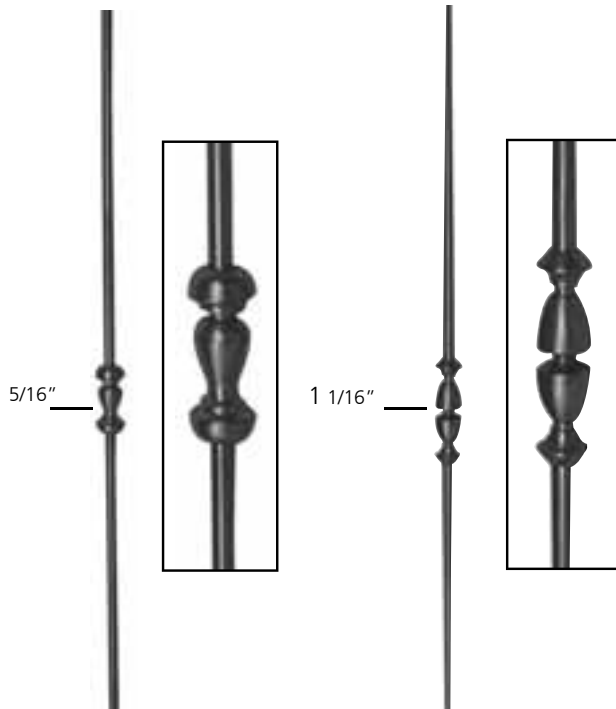

**Art. GD251/3**  
Mtl 1/2" dia.  
H 39 3/8"  
Wt. 2.6 lbs.

**Art. GD251/4**  
Mtl 1/2" dia.  
H 39 3/8"  
Wt. 2.4 lbs.

Shown: 1187/1



# New Items



Art. 755/2  
Mtl 5/8" dia.  
35 7/16" H  
Wt. 4.2 lbs.



Art. 755/3  
Mtl 5/8" dia.  
35 7/16" H  
Wt. 4.7 lbs.



Art. 755/4  
Mtl 5/8" dia.  
35 7/16" H  
Wt. 3.8 lbs.

Shown: 755/2



# New Items

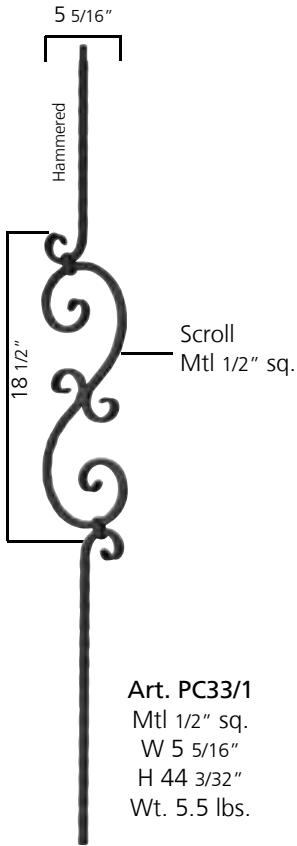

Art. PC33/1  
Mtl 1/2" sq.  
W 5 5/16"  
H 44 3/32"  
Wt. 5.5 lbs.

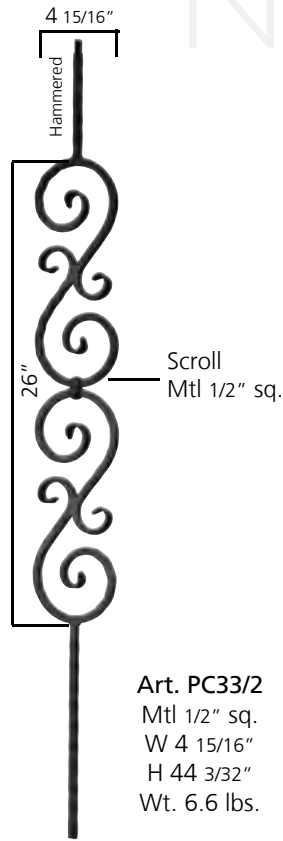

Art. PC33/2  
Mtl 1/2" sq.  
W 4 15/16"  
H 44 3/32"  
Wt. 6.6 lbs.

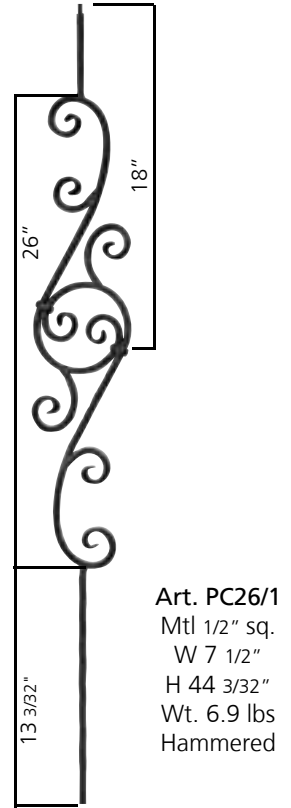

Art. PC26/1  
Mtl 1/2" sq.  
W 7 1/2"  
H 44 3/32"  
Wt. 6.9 lbs  
Hammered



Art. PC48/1  
Mtl 1/2" sq.  
W 2 3/4"  
H 44 3/32"  
Wt. 5 lbs.



Art. PC47/1  
Mtl 1/2" sq.  
W 4"  
H 44 3/32"  
Wt. 5.6 lbs.

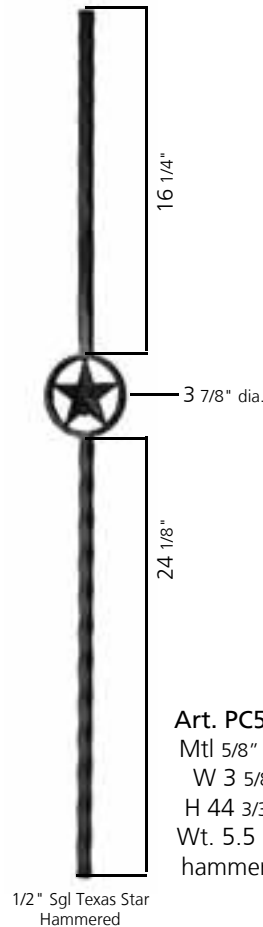

1/2" Sgl Texas Star  
Hammered

Art. PC52/1  
Mtl 5/8" sq.  
W 3 5/8"  
H 44 3/32"  
Wt. 5.5 lbs.  
hammered

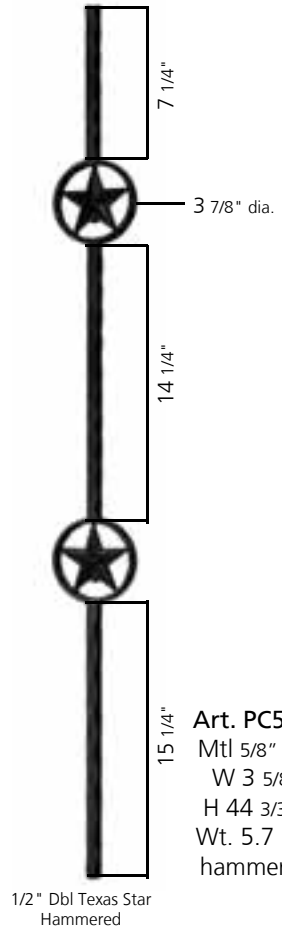

1/2" Dbl Texas Star  
Hammered

Art. PC52/2  
Mtl 5/8" sq.  
W 3 5/8"  
H 44 3/32"  
Wt. 5.7 lbs.  
hammered



# Forged Pickets

SUGGESTED NEWEL POSTS



Art. 112/5  
Mtl 1" sq.  
H 47"  
Wt. 12.54 lbs.

Art. 112/7  
Mtl 1" sq.  
H 47"  
Wt. 14.5 lbs.

Art. 799/3  
Mtl 1 9/16" sq.  
H 47"  
Wt. 37.4 lbs.



Art. 105/2  
Mtl 1/2" sq.  
H 39 3/8"  
Wt. 3.01 lbs.





Art. 105/1  
Mtl 1/2" sq.  
H 39 3/8"  
Wt. 3.3 lbs.



Art. 99/1  
Mtl 1/2" sq.  
H 39 3/8"  
Wt. 2.5 lbs.

Art. 99/2  
Mtl 1/2" sq.  
H 39 3/8"  
Wt. 2.5 lbs.

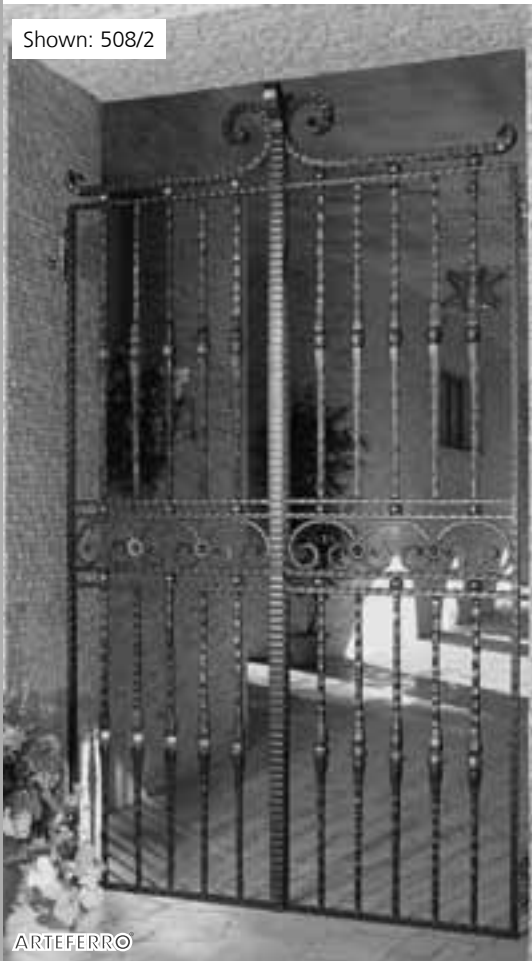
1 3/4"



3/8"

Art. 98/1  
H 39 3/8"  
Wt. 5.03 lbs.



Art. 508/2  
Mtl 11/16" sq.  
H 39 3/8"  
Wt. 7.68 lbs.



1 3/16" dia.  
7/8"

Art. 109/3  
H 39 3/8"  
Wt. 3.08 lbs.

SUGGESTED NEWEL POSTS



**Art. 797/2**  
Mtl 1 3/16" dia.  
H 47"  
Wt. 11.5 lbs.  
**Art. 797/7**  
Mtl 1 9/16" dia.  
H 47"  
Wt. 29 lbs.

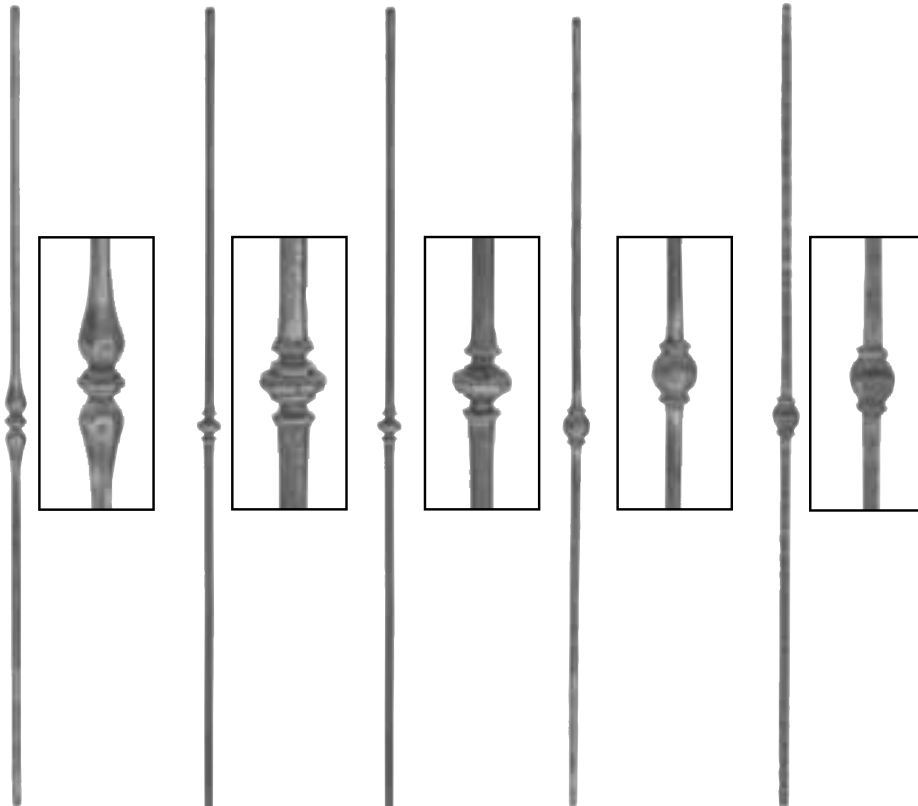

**Art. 1770/1**  
(ex 9000/8)  
Mtl 1/2" dia.  
H 39 3/8"  
Wt. 2.2 lbs.

**Art. 1770/2**  
(ex 9000/9)  
Mtl 1/2" dia.  
H 39 3/8"  
Wt. 2.2 lbs.

**Art. 1770/3**  
(ex 9000/10)  
Mtl 1/2" dia.  
H 39 3/8"  
Wt. 2.2 lbs.

**Art. 1770/4**  
(ex 9000/11)  
Mtl 1/2" dia.  
H 39 3/8"  
Wt. 2.2 lbs.

**Art. 1770/8**  
(ex 9000/15)  
Mtl 1/2" sq.  
H 39 3/8"  
Wt. 2.66 lbs.

Shown: 499/1



ARTEFERRO®

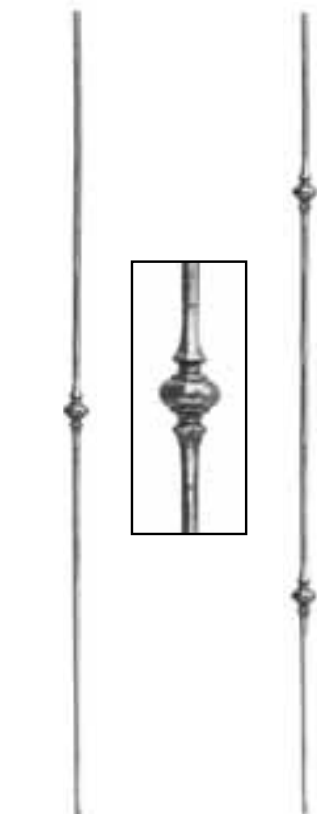

**Art. 499/1**  
Mtl 1/2" dia.  
H 39 3/8"  
Wt. 2.2 lbs.

**Art. 499/2**  
Mtl 1/2" dia.  
39 3/8" H  
Wt. 2.46 lbs.

Shown: 505/3

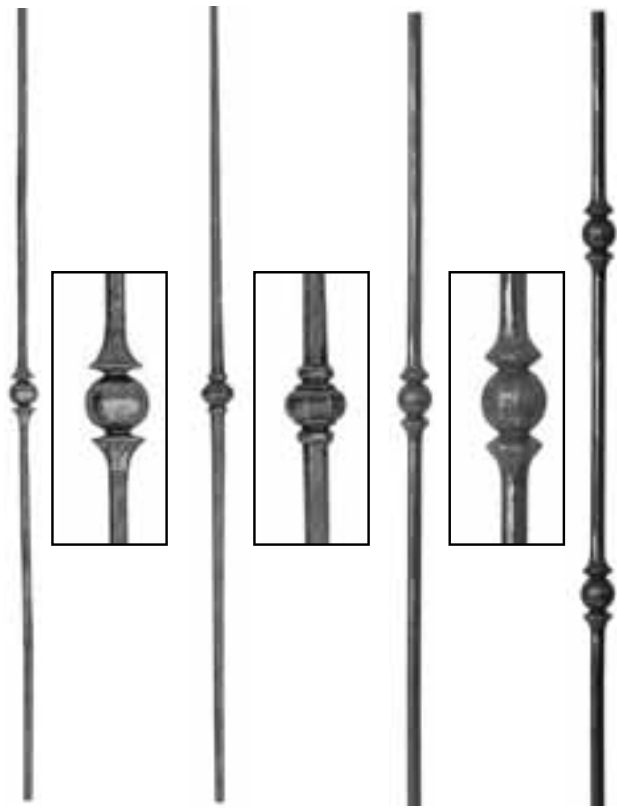

**Art. 1184/4**  
Mtl 1/2" dia.  
H 39 3/8"  
Wt. 2.2 lbs.

**Art. 1184/5**  
Mtl 9/16" dia.  
H 39 3/8"  
Wt. 3.0 lbs.

**Art. 504/2**  
Mtl 9/16" dia.  
H 39 3/8"  
Wt. 2.9 lbs.

**Art. 504/3**  
Mtl 9/16" dia.  
H 39 3/8"  
Wt. 3.5 lbs.



**Art. 505/3**  
Mtl 9/16" sq.  
H 39 3/8"  
Wt. 3.41 lbs.



**Art. 505/4**  
Mtl 9/16" sq.  
H 39 3/8"  
Wt. 3.92 lbs.

SUGGESTED NEWEL POSTS



**Art. 799/1**  
Mtl 1 3/16" sq.  
H 47"  
Wt. 14.5 lbs.

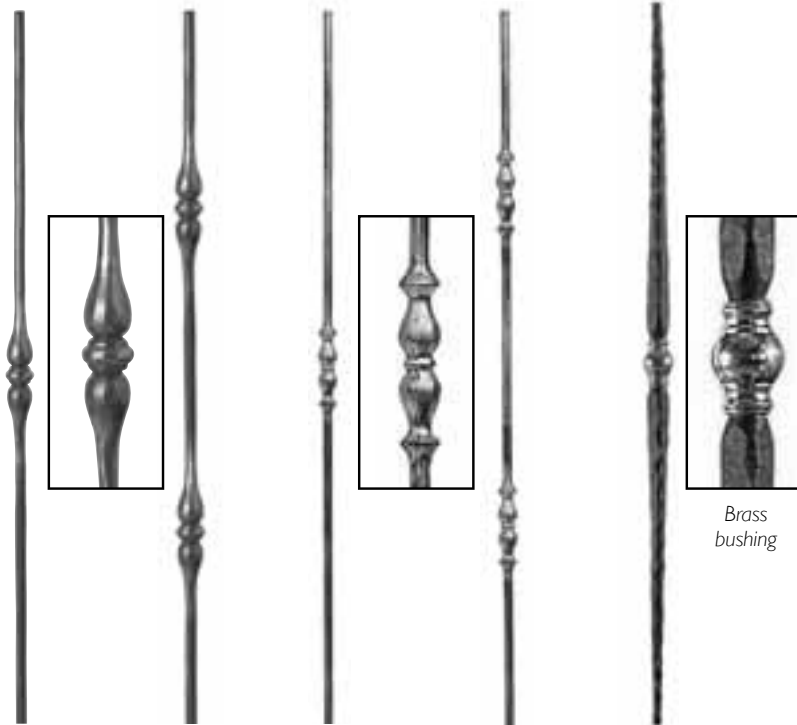

**Art. 508/3**  
 Mtl 9/16" dia.  
 H 39 3/8"  
 Wt. 4.0 lbs.

**Art. 508/4**  
 Mtl 9/16" dia.  
 H 39 3/8"  
 Wt. 5.3 lbs.

**Art. 497/1**  
 Mtl 1/2" dia.  
 H 39 3/8"  
 Wt. 2.2 lbs.

**Art. 497/2**  
 Mtl 1/2" dia.  
 H 39 3/8"  
 Wt. 2.64 lbs.

**Art. 111/2**  
 Mtl 1 17/32" dia.  
 H 35 7/16" approx  
 Wt. 4.2 lbs.

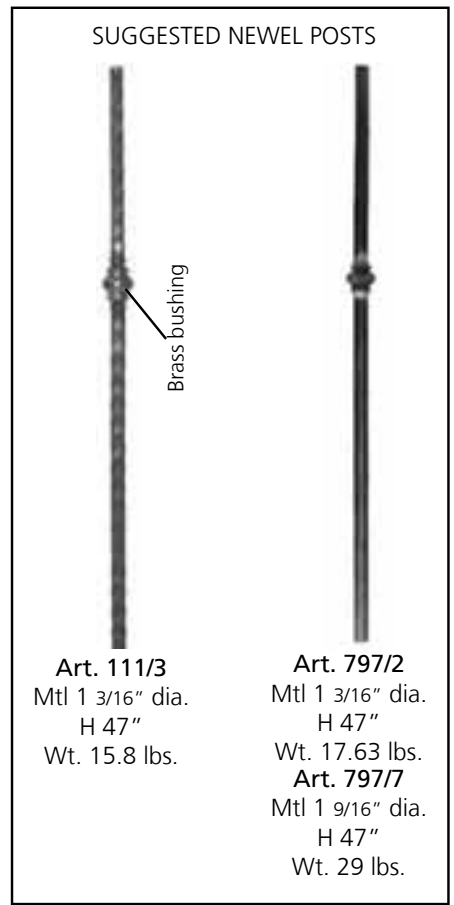

**Art. 111/3**  
 Mtl 1 3/16" dia.  
 H 47"  
 Wt. 15.8 lbs.

**Art. 797/2**  
 Mtl 1 3/16" dia.  
 H 47"  
 Wt. 17.63 lbs.

**Art. 797/7**  
 Mtl 1 9/16" dia.  
 H 47"  
 Wt. 29 lbs.

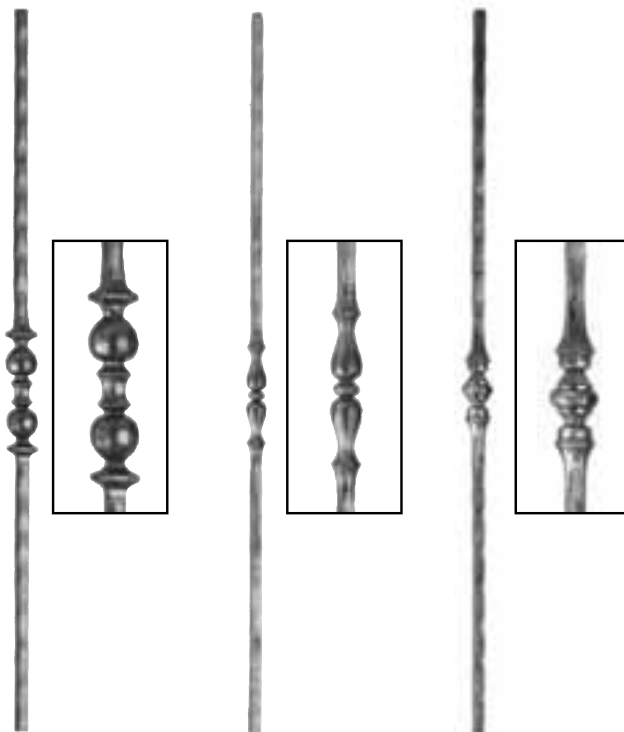

**Art. 1770/5**  
 (ex 9000/12)  
 Mtl 9/16" dia.  
 H 39 3/8"  
 Wt. 4.4 lbs.

**Art. 1770/6**  
 (ex 9000/13)  
 Mtl 1/2" sq.  
 H 39 3/8"  
 Wt. 2.58 lbs.

**Art. 1770/7**  
 (ex 9000/14)  
 Mtl 9/16" sq.  
 H 39 3/8"  
 Wt. 3.36 lbs.



# Forged Pickets

SUGGESTED NEWEL POSTS



Art. 112/10    Art. 112/9  
 Mtl 1 3/16" sq.    Mtl 1 3/16" sq.  
 H 47"            H 47"  
 Wt. 14.3 lbs.    Wt. 14.1 lbs.

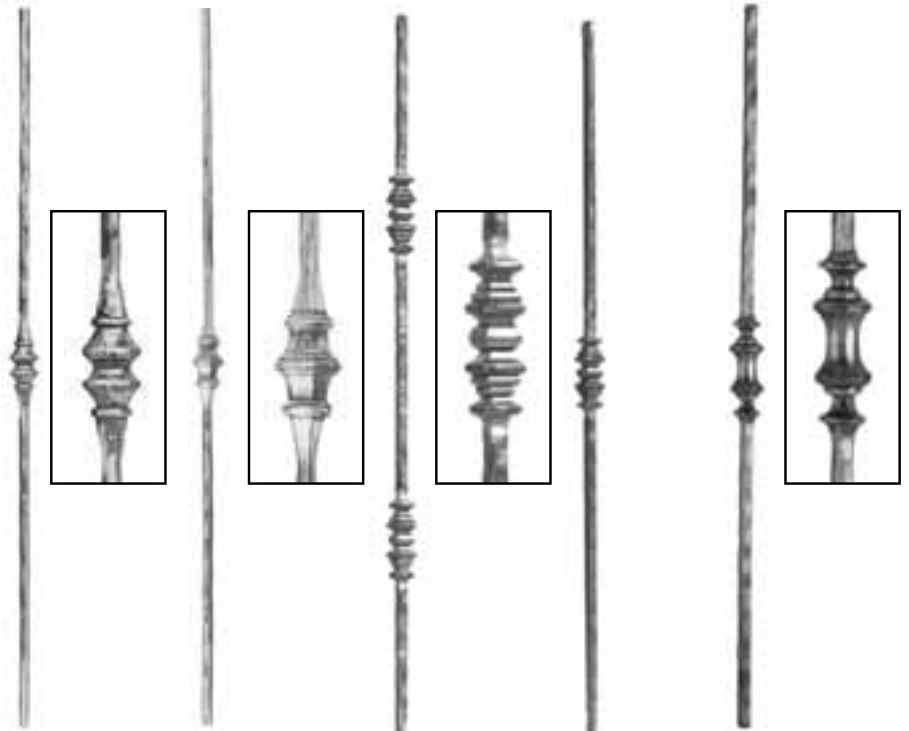

Art. 500/1    Art. 501/2    Art. 108/A/1    Art. 108/A/2    Art. 110/6  
 Mtl 1/2" dia.    Mtl 1/2" dia.    Mtl 1/2" sq.    Mtl 1/2" sq.    Mtl 9/16" sq.  
 H 39 3/8"    H 39 3/8"    H 39 3/8"    H 39 3/8"    H 39 3/8"  
 Wt. 2.4 lbs.    Wt. 2.57 lbs.    Wt. 3.7 lbs.    Wt. 3.5 lbs.    Wt. 4.0 lbs.

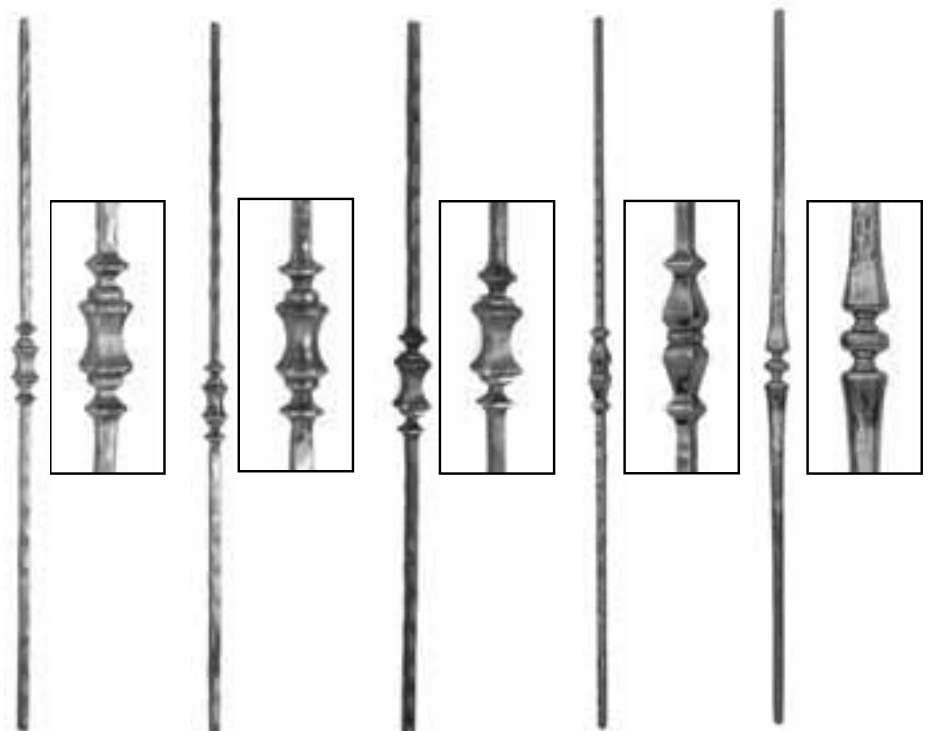
Art. 110/3    Art. 110/5    Art. 110/4    Art. 1185/1    Art. 1185/2  
 Mtl 1/2" sq.    Mtl 1/2" sq.    Mtl 9/16" sq.    Mtl 1/2" sq.    Mtl 33/64" dia.  
 H 39 3/8"    H 39 3/8"    H 39 3/8"    H 39 3/8"    H 39 3/8"  
 Wt. 3.08 lbs.    Wt. 3.05 lbs.    Wt. 3.92 lbs.    Wt. 2.2 lbs.    Wt. 4.19 lbs.





**Art. 1185/3**  
Mtl 1/2" dia.  
H 39 3/8"  
Wt. 3.3 lbs.



**Art. 1185/4**  
Mtl 1/2" dia.  
H 39 3/8" approx.  
Wt. 2 lbs.



**Art. 1184/3**  
Mtl 1/2" dia.  
H 39 3/8"  
Wt. 2.7 lbs.



**Art. 1184/6**  
Mtl 3/8" to 21/32"  
H 39 3/8"  
Wt. 2.21 lbs.

SUGGESTED NEWEL POSTS



**Art. 1775/15**  
Mtl 1" sq.  
H 47"  
Wt. 13 lbs.



**Art. 798/2**  
Mtl 1" sq.  
H 43"  
Wt. 11.4 lbs.

**Art. 1185/5**  
Mtl 19/16" dia.  
H 39 3/8" approx.  
Wt. 2.6 lbs.

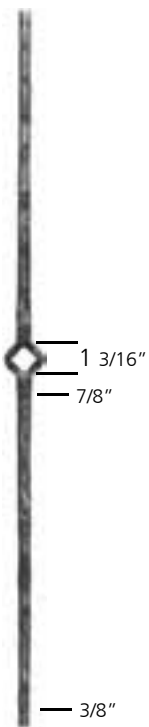

**Art. 101/2**  
Mtl 3/4" sq.  
H 39 3/8"  
Wt. 4 lbs.



**Art. 503/1**  
Mtl 1/2" dia.  
H 39 3/8"  
Wt. 2.8 lbs.

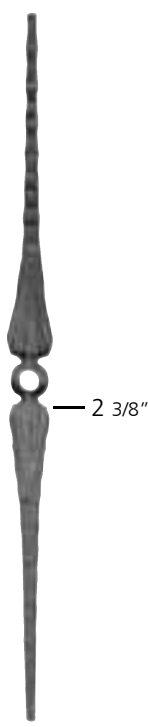

**Art. 1192/1**  
Mtl 1/2" x 5/16"  
H 39 3/8"  
Wt. 2.6 lbs.



**Art. 1192/2**  
Mtl 1/2" x 5/16"  
H 39 3/8"  
Wt. 3 lbs.



**Art. 502/1**  
Mtl 9/16" dia.  
H 39 3/8"  
Wt. 4.2 lbs.



# Forged Pickets

**SUGGESTED NEWEL POSTS**

2 3/4" Brass bushing

**Art. 111/3**  
Mtl 1 3/16" sq.  
47" H  
Wt. 15.8 lbs.

**Art. 112/5**  
Mtl 1" sq.  
H 47"  
Wt. 12.54 lbs.

**Art. 799/3**  
Mtl 1 9/16" sq.  
H 47"  
Wt. 37.4 lbs.



Art. 1214/1  
Art. 1214/2  
Art. 1214/3  
Art. 1214/4  
Murano Glass  
Bushings

2 11/64" 2 11/64" 2 11/64" 2 11/64"

**Art. 1215/1**  
Mtl 9/16" sq.  
H 39 3/8"  
Wt. 3.3 lbs.

**Art. 1215/2**  
Mtl 9/16" sq.  
H 39 3/8"  
Wt. 3.3 lbs.

**Art. 1215/3**  
Mtl 9/16" sq.  
H 39 3/8"  
Wt. 2.9 lbs.

**Art. 1215/4**  
Mtl 9/16" sq.  
H 39 3/8"  
Wt. 2.9 lbs.

# Forged Pickets 47 inches

1 3/4" dia. 7/8"

**Art. 1159/1**  
Mtl 1/2" dia.  
H 47"  
Wt. 2.4 lbs.

**Art. 1159/2**  
Mtl 1/2" dia.  
H 47"  
Wt. 2.8 lbs.

**Art. 1159/8**  
H 47"  
Wt. 5.1 lbs.

**Art. 1159/7**  
H 47"  
Wt. 4.1 lbs.

**Art. 1159/5**  
Mtl 1/2" sq.  
H 47"  
Wt. 3.7 lbs.

**Art. 1159/6**  
Mtl 1/2" sq.  
H 47"  
Wt. 4.0 lbs.

**Art. 500/2/L**  
Mtl 1/2" dia.  
H 47"  
Wt. 2.9 lbs.

**Art. 105/3/L**  
Mtl 9/16" sq.  
H 47"  
Wt. 3.5 lbs.

**Art. 105/4/L**  
Mtl 5/8" sq.  
H 47"  
Wt. 4.5 lbs.

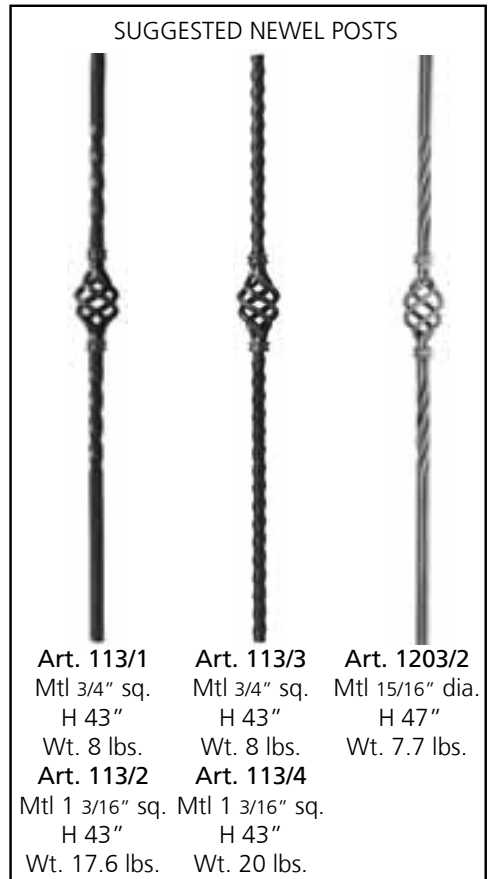
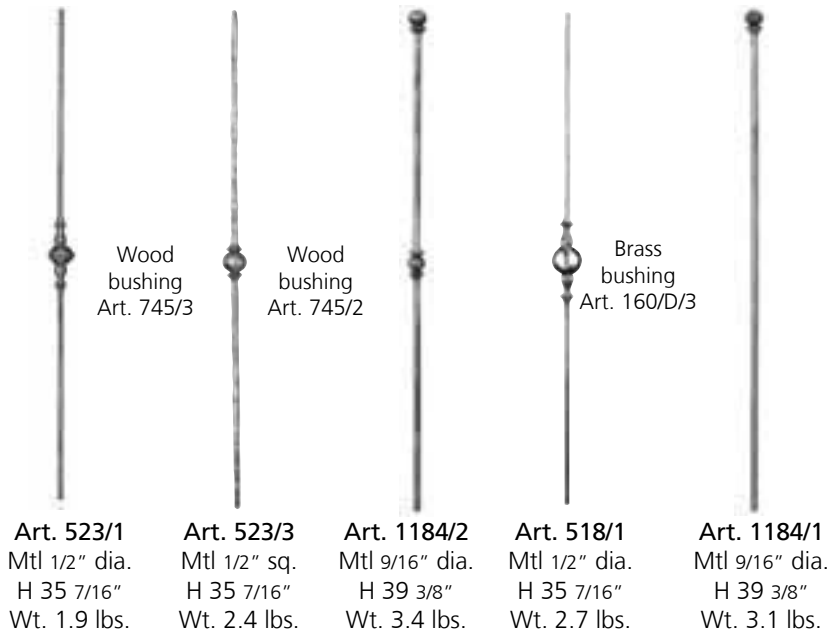

Picket with Baskets

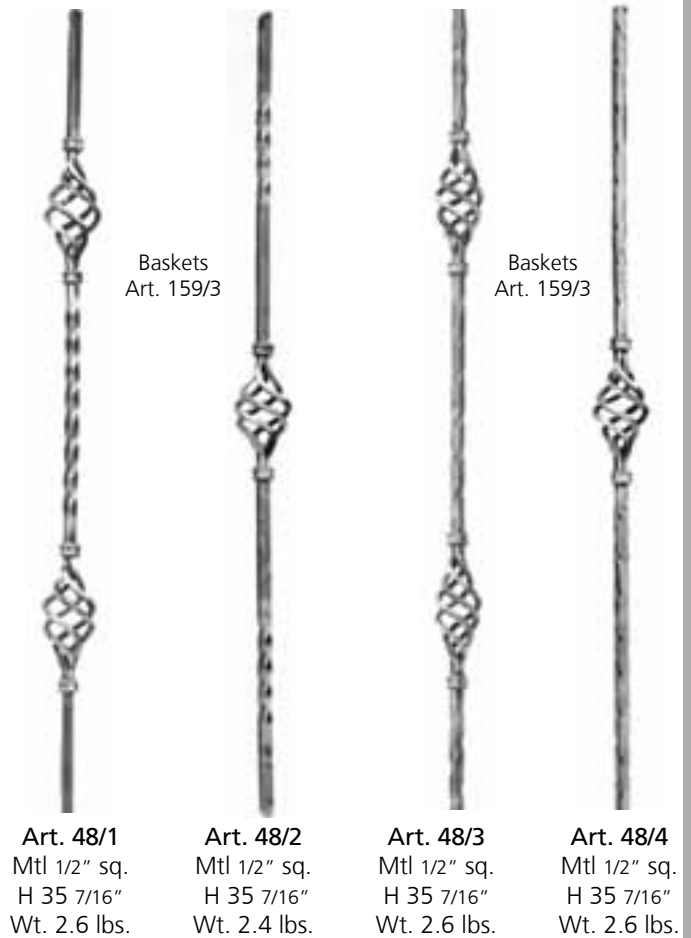

Shown: 1150/1 - 1150/2



ARTEFERRO

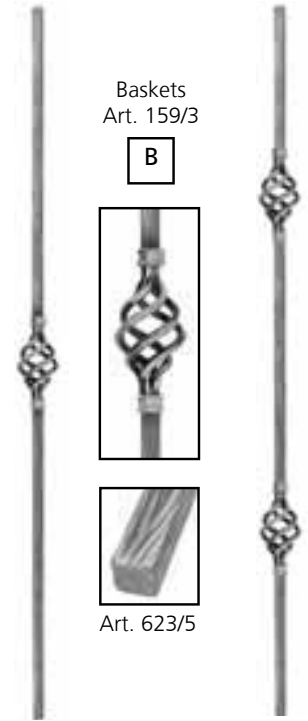

Baskets  
Art. 159/3



Art. 626/5

Baskets  
Art. 158/B/1

C



Art. 626/5

Art. 48/A/13  
Mtl 1/2" sq.  
H 35 7/16"  
Wt. 2.6 lbs.

Art. 48/A/16  
Mtl 1/2" sq.  
H 35 7/16"  
Wt. 2.4 lbs.

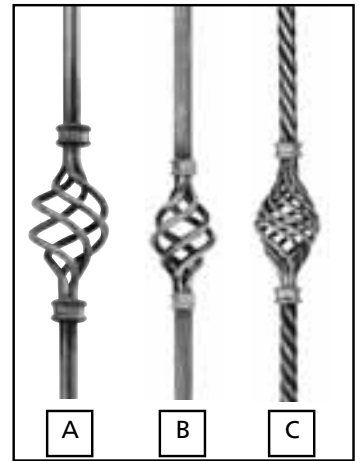

A

B

C

Art. 462/1  
Mtl 5/8" dia.  
H 35 7/16"  
Wt. 2 lbs.

Art. 462/2  
Mtl 5/8" dia.  
H 35 7/16"  
Wt. 2.4 lbs.

Art. 462/3  
Mtl 5/8" dia.  
H 35 7/16"  
Wt. 2 lbs.

Art. 462/4  
Mtl 5/8" dia.  
H 35 7/16"  
Wt. 2.4 lbs.

Baskets  
Art. 1466/12

Brass  
Baskets



Baskets  
Art. 1466/12

Brass  
Baskets



Baskets  
Art. 1466/12

Brass  
Baskets



Baskets  
Art. 1163/3

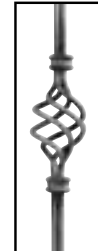

Art. 626/11

A

Baskets  
Art. 1163/3



Art. 626/11

Art. 1149/1  
Mtl 1/2" sq.  
H 39 3/8"  
Wt. 2.7 lbs.

Art. 1149/2  
Mtl 1/2" sq.  
H 39 3/8"  
Wt. 2.8 lbs.

Art. 1149/3  
Mtl 1/2" sq.  
H 39 3/8"  
Wt. 2.7 lbs.

Art. 1149/4  
Mtl 1/2" sq.  
H 39 3/8"  
Wt. 2.8 lbs.

Art. 1149/5  
Mtl 1/2" sq.  
H 39 3/8"  
Wt. 2.7 lbs.

Art. 1149/6  
Mtl 1/2" sq.  
H 39 3/8"  
Wt. 2.8 lbs.

Art. 1150/1  
Mtl 1/2" x 1/2"  
H 39 3/8"  
Wt. 2.7 lbs.

Art. 1150/2  
Mtl 1/2" x 1/2"  
H 39 3/8"  
Wt. 2.8 lbs.

Art. 1150/3  
Mtl 1/2" x 1/2"  
H 39 3/8"  
Wt. 2.7 lbs.

Art. 1150/4  
Mtl 1/2" x 1/2"  
H 39 3/8"  
Wt. 2.7 lbs.



Most of the wrought iron designs shown in this catalog can be custom produced to specific dimensions

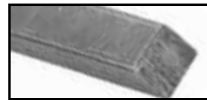

Cod.Art./Art.no.	Article	Article	Article
Section	H 35 7/16"	H 39 3/8"	H 47 1/4"
Lbs.	4.0	4.4	5.3
1/2" sq.	GD106/1	GD106/4	GD106/7
9/16" sq.	GD106/2	GD106/5	GD106/8
5/8" sq.	GD106/3	GD106/6	GD106/9

OFFERING SPECIAL PRODUCTION  
LARGER DIAMETERS  
CHECK WITH SALES

35 1/2" , 40" , 42" and 47" Baluster Lengths - 5 Twists

CUSTOM MANUFACTURED IN THE USA.

Other sizes available please inquire.

1/2" SQUARE SOLID PICKETS WITH TWIST PATTERN

Art.	Mtl	Stock Length	Wt.
11-38365	3/8" sq.	35 1/2"	1.5 lbs.
11-3840	3/8" sq.	40"	1.7 lbs.
11-3842	3/8" sq.	42"	1.75 lbs.
11-3847	3/8" sq.	47"	2 lbs.

Art.	Mtl	Stock Length	Wt.
11-12365	1/2" sq.	35 1/2"	2.5 lbs.
11-1240	1/2" sq.	40"	2.8 lbs.
11-1242	1/2" sq.	42"	3 lbs.
11-1247	1/2" sq.	47"	3.3 lbs.

Art.	Mtl	Stock Length	Wt.
11-58365	5/8" sq.	35 1/2"	3.9 lbs.
11-5840	5/8" sq.	40"	4.4 lbs.
11-5842	5/8" sq.	42"	4.6 lbs.
11-5847	5/8" sq.	47"	5.2 lbs.

Art.	Mtl	Stock Length	Wt.
11-34365	3/4" sq.	35 1/2"	5.6 lbs.
11-3440	3/4" sq.	40"	6.3 lbs.
11-3442	3/4" sq.	42"	6.6 lbs.
11-3447	3/4" sq.	47"	7.4 lbs.

LONG BARS - STOCK LENGTH 20'

Art.	Mtl	Stock Length	Wt.
11-38T	3/8" sq.	(20') 25 Twist	10 lbs.
11-12T	1/2" sq.	(20') 21 Twist	17 lbs.
11-58240	5/8" sq.	(20') 19 Twist	26 1/2" lbs.
11-34240	3/4" sq.	(20') 15 Twist	38 lbs.
118-H25	1" sq.	(118")12 Twist	34 lbs.

Double Twist

Art.	Length	Wt.
53-3	35 1/2"	2.5 lbs.
53-340	40"	2.5 lbs.
53-342	42"	2.6 lbs.
53-347	47"	2.8 lbs.

Single Twist

Art.	Length	Wt.
65-8	35 1/2"	2.5 lbs.
65-840	40"	2.5 lbs.
65-842	42"	2.6 lbs.
65-847	47"	2.8 lbs.

A

B

C

D

E

F

Art.	Mtl	Length	Wt.
1724/13	2 3/8" x 1 3/16"	39 1/2"	31.1 lbs.
1724/14	2 3/8" x 1 3/16"	47 1/4"	37.4 lbs.

Art.	Mtl	Length	Wt.
1724/27	1 31/32" sq.	39 1/2"	43.2 lbs.
1724/28	1 31/32" sq.	47 1/4"	51.9 lbs.

Art.	Mtl	Length	Wt.
1724/51	1 31/32" sq.	39 1/2"	43.2 lbs.
1724/52	1 31/32" sq.	47 1/4"	51.9 lbs.

Art.	Mtl	Length	Wt.
1725/1	2" sq.	39 1/2"	43.2 lbs.
1725/2	2" sq.	47 1/4"	51.9 lbs.

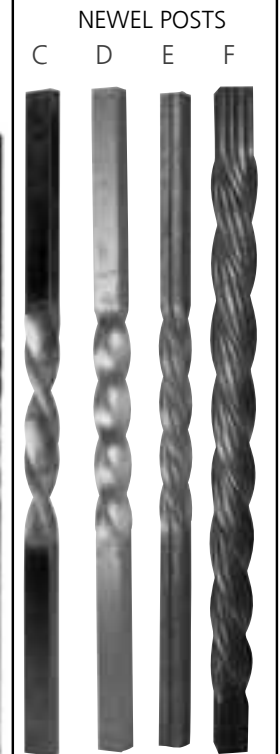

Custom lengths available  
Left twist



# Forged Pickets

## SUGGESTED NEWEL POSTS



**Art. 1775/13**  
Mtl 1" sq.  
H 47"  
Wt. 13 lbs.  
**Art. 1775/14**  
Mtl 1 3/16" sq.  
H 47"  
Wt. 18.7 lbs.



**Art. 112/3**  
Mtl 1" sq.  
H 47"  
Wt. 14 lbs.



**Art. 70/D/1**  
Mtl 9/16 sq.  
H 35 7/16"  
Wt. 3 lbs.



**Art. 118/H/1**  
Mtl 1/2" sq.  
H 35 7/16"  
Wt. 2.5 lbs.



**Art. 118/H/2**  
Mtl 1/2" sq.  
H 35 7/16"  
Wt. 2.5 lbs.



**Art. 597/3**  
Mtl 9/16 sq.  
H 35 7/16"  
Wt. 3 lbs.



**Art. 1132/9**  
Mtl 9/16 sq.  
H 39 3/8"  
Wt. 2.6 lbs.

Shown: 118/H/2



Cast iron bushing



Art. 746/1



**Art. 755/5**  
Mtl 1/2" sq.  
H 35 7/16"  
Wt. 2.5 lbs.

**Art. 755/6**  
Mtl 1/2" sq.  
H 35 7/16"  
Wt. 2.6 lbs.



**Art. 50/5**  
Mtl 1/2" sq.  
W 1 3/16"  
H 35 7/16"  
Wt. 2.1 lbs.



**Art. 50/6**  
Mtl 1/2" sq.  
W 1 3/16"  
H 35 7/16"  
Wt. 2.2 lbs.



**Art. 50/7**  
Mtl 1/2" sq.  
W 5 1/2"  
H 35 7/16"  
Wt. 2.8 lbs.



**Art. 50/8**  
Mtl 1/2" sq.  
W 5 1/2"  
H 35 7/16"  
Wt. 3.4 lbs.

SUGGESTED NEWEL POSTS



**Art. 113/5**  
Mtl 3/4" sq.  
H 43"  
Wt. 8.4 lbs.



**Art. 64/I/1**  
Mtl 1" sq.  
H 47"  
Wt. 14.7 lbs.

**Art. 113/6**  
Mtl 1 3/16" sq.  
H 43"  
Wt. 17 lbs.



**Art. 64/I/3**  
Mtl 9/16" sq.  
H 35 7/16"  
Wt. 3.3 lbs.



**Art. 64/I/2**  
Mtl 9/16" sq.  
H 35 7/16"  
Wt. 3.6 lbs.



**Art. 64/L/3**  
Mtl 9/16" dia.  
H 35 7/16"  
Wt. 2.3 lbs.



**Art. 64/L/4**  
Mtl 9/16" dia.  
H 35 7/16"  
Wt. 2.3 lbs.

Round  
Bushing



Art. 128/2



# Forged Pickets



Art. 1749/2  
(ex 9116/7)  
Mtl 9/16" sq.  
H 39 3/8"  
Wt. 3.4 lbs.



Art. 1749/4  
(ex 9116/8)  
Mtl 9/16" sq.  
H 39 3/8"  
Wt. 3.4 lbs.



Art. 1749/6  
(ex 9116/9)  
Mtl 9/16" sq.  
H 39 3/8"  
Wt. 3.6 lbs.



Art. 116/A/4  
Floral is single-faced



Art. 1749/8  
(ex 9116/10)  
Mtl 9/16" sq.  
H 39 3/8"  
Wt. 3.6 lbs.



Shown: 1179/3



Brass bushing  
Art. 746/1



Art. 1179/3  
Mtl 9/16" dia.  
H 39 11/32"  
Wt. 3.4 lbs.



Baskets  
Art. 158/B/6  
4 filaments

Art. 64/I/4  
Mtl 9/16" sq.  
H 35 7/16"  
Wt. 4 lbs.



Baskets  
Art. 158/B/7  
6 filaments

Art. 64/I/5  
Mtl 9/16" sq.  
H 35 7/16"  
Wt. 4 lbs.



Art. 134/G/3  
Mtl 1/2" sq.  
H 35 7/16"  
Wt. 2.2 lbs.



Art. 1091/1  
Mtl 1/2" sq.  
W 5 5/16"  
H 39 3/8"  
Wt. 3.5 lbs.



Art. 1091/2  
Mtl 1/2" sq.  
W 5 5/16"  
H 39 3/8"  
Wt. 4.4 lbs.

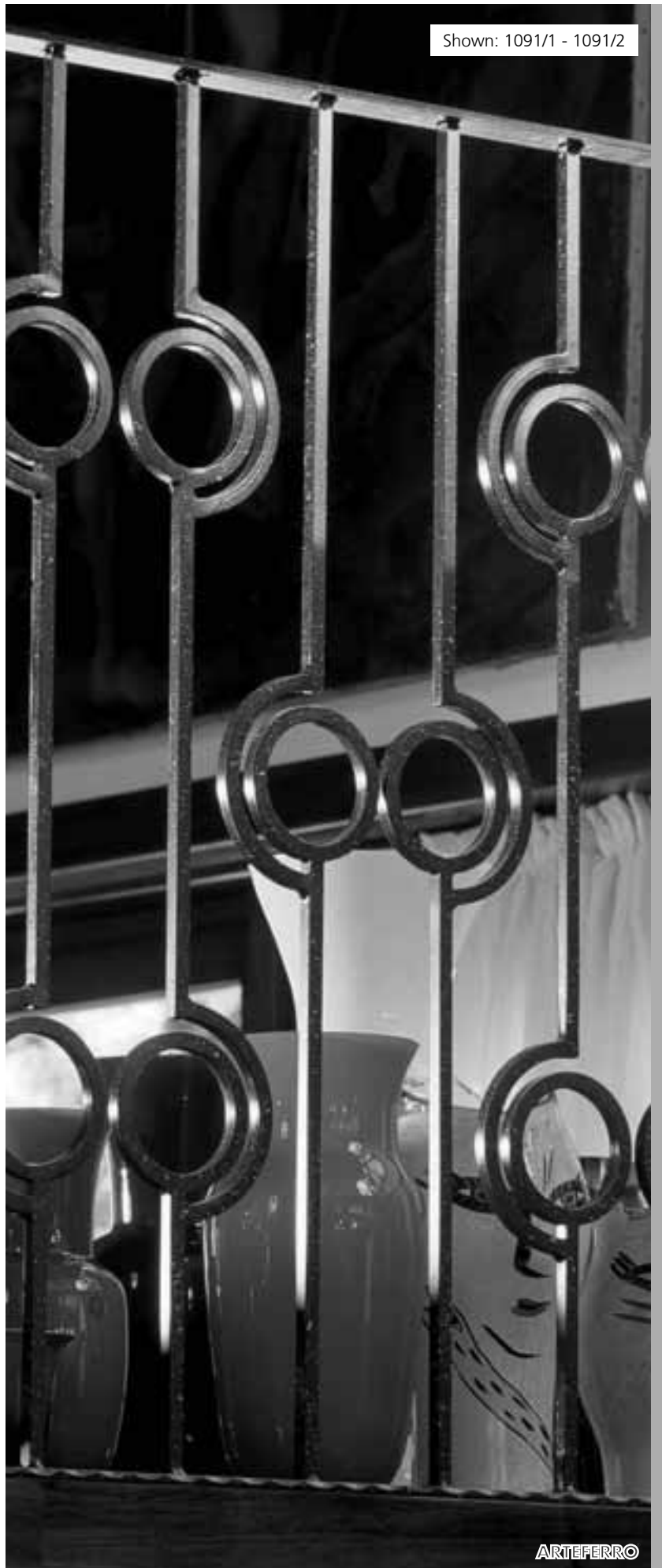

# Stair and Rail Balusters

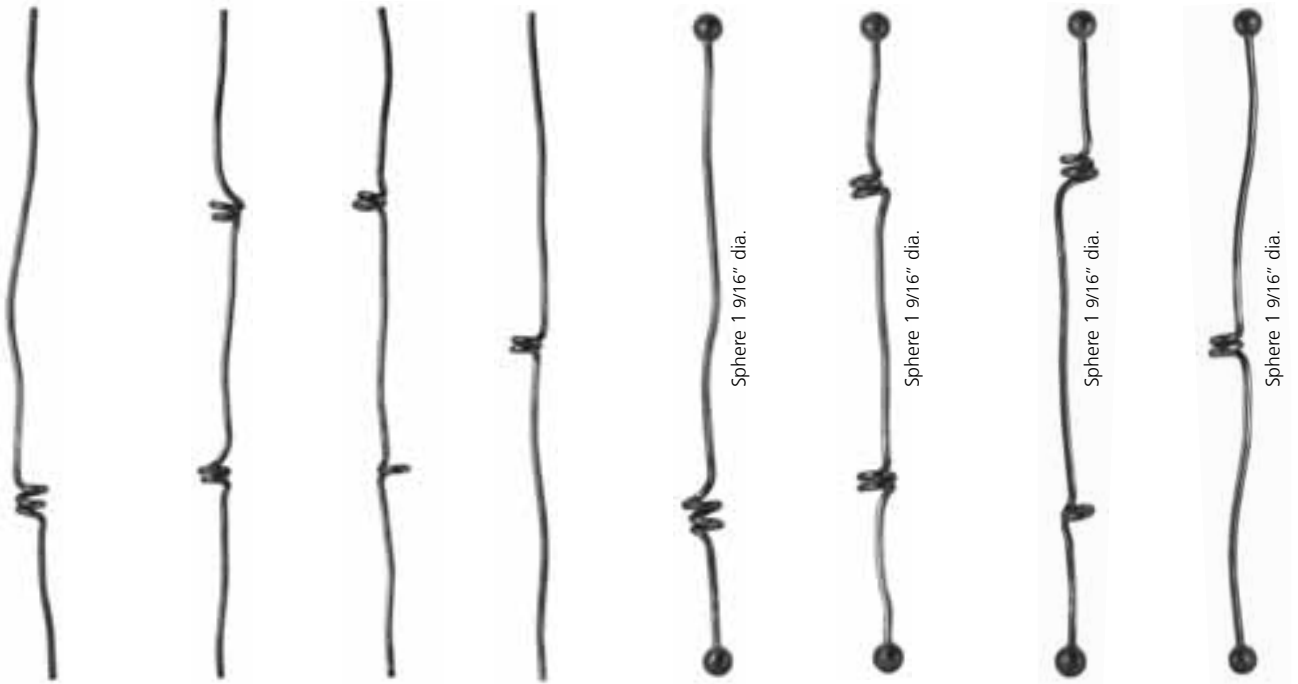

**Art. 1167/3**  
Mtl 1/2" dia.  
H 39 3/8"  
Wt. 2.4 lbs.

**Art. 1167/4**  
Mtl 1/2" dia.  
H 39 3/8"  
Wt. 2.7 lbs.

**Art. 1167/1**  
Mtl 1/2" dia.  
H 39 3/8"  
Wt. 2.5 lbs.

**Art. 1167/2**  
Mtl 1/2" dia.  
H 39 3/8"  
Wt. 2.3 lbs.

**Art. 1166/3**  
Mtl 1/2" dia.  
H 35 7/16"  
Wt. 3.3 lbs.

Sphere 1 9/16" dia.

**Art. 1166/4**  
Mtl 1/2" dia.  
H 35 7/16"  
Wt. 3.6 lbs.

Sphere 1 9/16" dia.

**Art. 1166/1**  
Mtl 1/2" dia.  
H 35 7/16"  
Wt. 3.5 lbs.

Sphere 1 9/16" dia.

**Art. 1166/2**  
Mtl 1/2" dia.  
H 35 7/16"  
Wt. 2.9 lbs.

Sphere 1 9/16" dia.

## SUGGESTED NEWEL POSTS



**Art. 1207/3**  
Mtl 2 15/16" dia.  
W 3 15/16"  
H 47"  
Wt. 24 lbs.



**Art. 1206/1**  
Mtl 1 3/16" sq.  
W 10 5/8"  
H 47"  
Wt. 14 lbs.



**Art. 1089/1**  
Mtl 1/2" sq.  
W 3 15/16"  
H 39 3/8"  
Wt. 3.4 lbs.



**Art. 1089/2**  
Mtl 1/2" sq.  
W 3 15/16"  
H 39 3/8"  
Wt. 4.2 lbs.



**Art. 1090/1**  
Mtl 1/2" sq.  
W 4 1/2"  
H 39 3/8"  
Wt. 3.3 lbs.



**Art. 1090/2**  
Mtl 1/2" sq.  
W 4 1/2"  
H 39 3/8"  
Wt. 4 lbs.



**Art. 1090/3**  
Mtl 1/2" sq.  
W 3 9/16"  
H 39 3/8"  
Wt. 3.1 lbs.



**Art. 1090/4**  
Mtl 1/2" sq.  
W 3 9/16"  
H 39 3/8"  
Wt. 3.8 lbs.



The 64/F series (and other matching components) are one of our most popular lines. The bars are first hammered on all four edges, and then the pattern is added to both sides. Scrolls, flowers, and baskets are then added.



**Art. 64/F/3**  
Mtl 9/16" sq.  
H 35 7/16"  
Wt. 3 lbs.



**Art. 64/F/5**  
Mtl 9/16" sq.  
H 35 7/16"  
Wt. 3 lbs.



**Art. 64/F/9**  
Mtl 9/16" sq.  
W 4 5/16"  
H 35 7/16"  
Wt. 4.1 lbs.

Floral is single-faced



**Art. 64/F/7**  
Mtl 9/16" sq.  
W 5 1/2"  
H 35 7/16"  
Wt. 3.4 lbs.

SUGGESTED NEWEL POSTS



**Art. 64/F/1**  
Mtl 1" sq.  
H 47"  
Wt. 13 lbs.



**Art. 64/I/1**  
Mtl 1" sq.  
H 47"  
Wt. 14.7 lbs.



**Art. 562/2**  
Mtl 9/16" sq.  
H 35 7/16"  
Wt. 3.1 lbs.



**Art. 561/6**  
Mtl 9/16" sq.  
W 8 1/4"  
H 35 7/16"  
Wt. 4.2 lbs.

Floral is single-faced



**Art. 64/G/2**  
Mtl 9/16" sq.  
W 8 7/8"  
H 35 7/16"  
Wt. 5.2 lbs.



Shown: 164/F/3 - 64/F/5

ARTEFERRO

# Hammered Stair and Rail Balusters

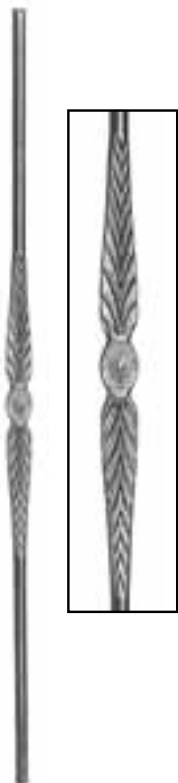

**Art. 576/2**  
Mtl 9/16" dia.  
H 35 7/16"  
Wt. 2.5 lbs.  
**Art. 1135/3**  
Mtl 9/16" dia.  
H 39 3/8"  
Wt. 2.6 lbs.



**Art. 576/4**  
Mtl 9/16" dia.  
H 35 7/16"  
Wt. 2.5 lbs.  
**Art. 1135/4**  
Mtl 9/16" dia.  
H 39 3/8"  
Wt. 2.6 lbs.



**Art. 577/1**  
Mtl 9/16" dia.  
W 8 1/4"  
H 35 7/16"  
Wt. 3.9 lbs.



**Art. 577/2**  
Mtl 9/16" dia.  
W 6 5/8"  
H 35 7/16"  
Wt. 3.6 lbs.



**Art. 577/3**  
Mtl 9/16" dia.  
W 6 5/8"  
H 35 7/16"  
Wt. 3.6 lbs.

SUGGESTED NEWEL POSTS



**Art. 801/5**  
Mtl 1" dia.  
H 47"  
Wt. 11 lbs.  
**Art. 801/8**  
Mtl 1 3/16" dia.  
H 47"  
Wt. 11 lbs.

Shown: 1135/1 - 576/2

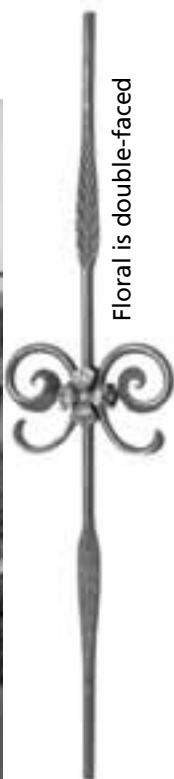

**Art. 1135/1**  
Mtl 9/16" dia.  
W 8 5/8"  
H 39 3/8"  
Wt. 4.4 lbs.

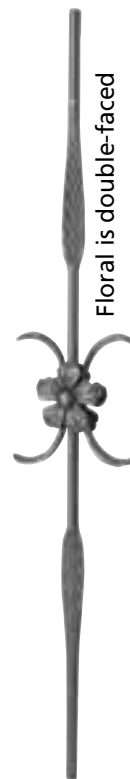

**Art. 1135/2**  
Mtl 9/16" dia.  
W 8 5/8"  
H 39 3/8"  
Wt. 3.7 lbs.



**Art. 560/2**  
Mtl 9/16" dia.  
H 35 7/16"  
Wt. 3.3 lbs.

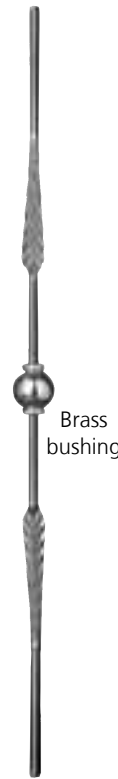

**Art. 560/3**  
Mtl 9/16" dia.  
H 35 7/16"  
Wt. 3 lbs.

# Hammered Stair and Rail Balusters



Scrolls  
Art. 1296/8

**Art. 1136/7**  
Mtl 9/16" sq.  
W 6 1/8"  
H 39 3/8"  
Wt. 3.9 lbs.



**Art. 1136/8**  
Mtl 9/16" sq.  
W 7 7/8"  
H 39 3/8"  
Wt. 4.3 lbs.



**Art. 1136/9**  
Mtl 9/16" sq.  
H 39 3/8"  
Wt. 3.4 lbs.



**Art. 1136/10**  
Mtl 9/16" sq.  
H 39 3/8"  
Wt. 3.4 lbs.

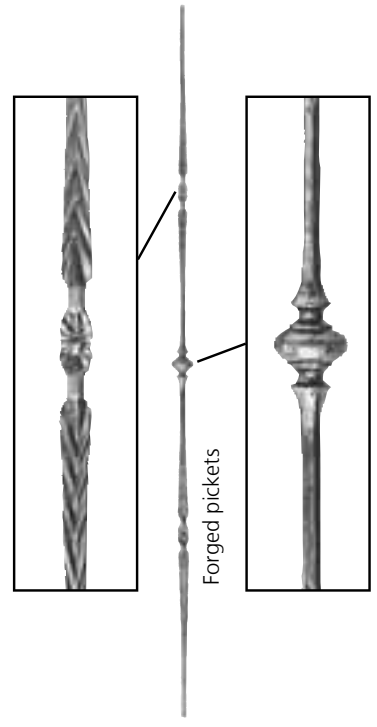

**Art. 504/1**  
Mtl 1/2" dia.  
H 39 3/8"  
Wt. 1.9 lbs.



Scrolls  
Art. 1296/12

**Art. 1136/1**  
Mtl 9/16" dia.  
H 39 3/8"  
Wt. 3.4 lbs.



Scrolls  
Art. 1296/13

**Art. 1136/2**  
Mtl 9/16" dia.  
W 7 7/8"  
H 39 3/8"  
Wt. 4.6 lbs.



Shown: 504/1

Shown: 1171/1 - 1171/2



**Art. 1170/1**  
Mtl 1/2" dia.  
W 5 1/8"  
H 39 3/8"  
Wt. 3.3 lbs.



**Art. 1171/2**  
Mtl 1/2" dia.  
W 2 3/8"  
H 39 3/8"  
Wt. 2.2 lbs.

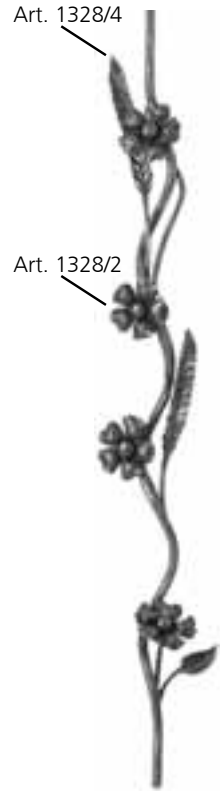

**Art. 1171/1**  
Mtl 1/2" dia.  
W 4 3/4"  
H 39 3/8"  
Wt. 4.4 lbs.



**Art. 604/6**  
Mtl 1/2" dia.  
H 39 3/8"  
Wt. 4 lbs.



**Art. 604/8**  
Mtl 1/2" dia.  
H 39 3/8"  
Wt. 3 lbs.



**Art. 604/12**



**Art. 604/7**  
Mtl 1/2" dia.  
H 39 3/8"  
Wt. 3 lbs.



Art. GD176/1  
Mtl 9/16 sq.  
W 7 7/8"  
H 39 3/8"  
Wt. 7.9 lbs.



Art. GD176/3  
Mtl 9/16 sq.  
W 7 7/8"  
H 39 3/8"  
Wt. 9 lbs.

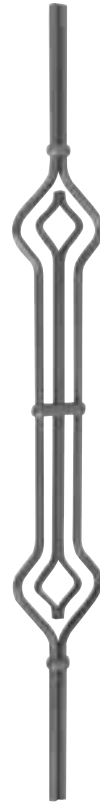

Art. GD193/1  
Mtl 1/2" dia.  
W 5 1/8"  
H 39 3/8"  
Wt. 6 lbs.

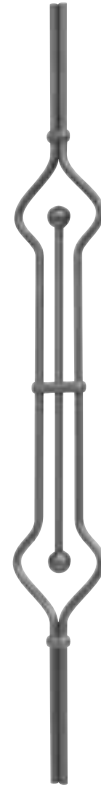

Art. GD192/3  
Mtl 1/2" dia.  
W 5 1/8"  
H 39 3/8"  
Wt. 5.7 lbs.



Art. GD23/1  
Mtl 9/16 sq.  
W 4 23/32"  
H 39 3/8"  
Wt. 3.9 lbs.



Art. GD25/1  
Mtl 9/16 sq.  
W 4 23/32"  
H 39 3/8"  
Wt. 4.5 lbs.



Shown: GD23/1 - GD25/1

Shown: 1685/3 - GD 23/1



ARTEFERRO



Art. GD158/1  
Mtl 9/16" x 5/16"  
W 6 19/64"  
H 39 3/8"  
Wt. 6.6 lbs.



Art. GD158/2  
Mtl 9/16" x 5/16"  
W 6 19/64"  
H 39 3/8"  
Wt. 6.2 lbs.



Art. GD228/2  
Mtl 9/16" x 5/16"  
W 7 1/2"  
H 39 3/8"  
Wt. 6.8 lbs.

Rosettes | 16/A/4 on both sides



Art. 1685/3  
(ex 9133/5)  
Mtl 9/16" sq.  
H 39 3/8"  
Wt. 2.3 lbs.



Art. GD156/1  
Mtl 9/16" x 5/16"  
W 3 5/32"  
H 39 3/8"  
Wt. 2.9 lbs.



Art. GD156/2  
Mtl 9/16" x 5/16"  
W 6 5/8"  
H 39 3/8"  
Wt. 4.8 lbs.



Art. 1699/9  
Mtl 1/2" dia.  
W 5 1/8"  
H 39 3/8"  
Wt. 4.6 lbs.



Art. GD41/1  
Mtl 1/2" dia.  
W 2 23/64"  
H 39 3/8"  
Wt. 2.1 lbs.



Art. 1699/3  
Mtl 1/2" dia.  
W 2 23/64"  
H 39 3/8"  
Wt. 2.1 lbs.



# Stair and Rail Balusters



**Art. 1049/1**  
Mtl 9/16"  
W 10 1/4"  
H 39 3/8"  
Wt. 8.4 lbs.



**Art. 1051/1**  
Mtl 1/2" sq.  
W 7 9/32"  
H 39 3/8"  
Wt. 4.0 lbs.



**Art. 1051/2**  
Mtl 1/2" sq.  
W 5 7/8"  
H 39 3/8"  
Wt. 4.0 lbs.



**Art. 1051/3**  
Mtl 1/2" sq.  
W 5 7/8"  
H 39 3/8"  
Wt. 4.0 lbs.

SUGGESTED NEWEL POSTS

**Art. 113/1**  
Mtl 3/4" sq.  
H 43"  
Wt. 8.1 lbs.

**Art. 113/7**  
Mtl 3/4" sq.  
H 43"  
Wt. 13 lbs.

**Art. 113/2**  
Mtl 1 3/16" sq.  
H 43"  
Wt. 19.0 lbs.

**Art. 113/8**  
Mtl 1 3/16" sq.  
H 43"  
Wt. 15 lbs.



**Art. 52/2**  
Mtl 1/2" sq.  
W 9 1/4"  
H 35 7/16"  
Wt. 5.5 lbs.



**Art. 52/A/3**  
Mtl 1/2" sq.  
W 6 5/8"  
H 35 7/16"  
Wt. 3.5 lbs.



Shown: 1051/3

Shown: 53/1



Art. 60/3  
Mtl 1/2" sq.  
W 4 3/4"  
H 35 7/16"  
Wt. 4 lbs.



Art. 64/A/3  
Mtl 1/2" sq.  
W 8 5/8"  
H 35 7/16"  
Wt. 4 lbs.



Art. 64/B/2  
Mtl 1/2" sq.  
W 8 5/8"  
H 35 7/16"  
Wt. 4.4 lbs.

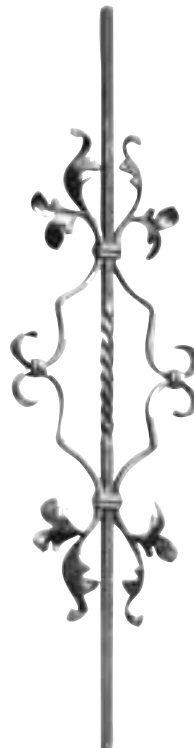

Art. 53/1  
Mtl 1/2" sq.  
W 9 1/4"  
H 35 7/16"  
Wt. 5.1 lbs.



Art. 113/4  
Mtl 1 3/16" sq.  
H 43"  
Wt. 17.6 lbs.

Art. 113/8  
Mtl 1 3/16" sq.  
H 43"  
Wt. 18.5 lbs.

Shown: 487/1

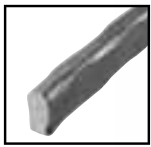

**Art. 486/1**  
Mtl 5/8" x 5/16"  
W 5 1/2"  
H 35 7/16"  
Wt. 4.6 lbs.

**Art. 487/1**  
Mtl 5/8" x 5/16"  
W 9 1/16"  
H 35 7/16"  
Wt. 4.6 lbs.

**Art. 488/1**  
Mtl 5/8" x 5/16"  
W 7 1/2"  
H 35 7/16"  
Wt. 7.5 lbs.



ARTEFERRO

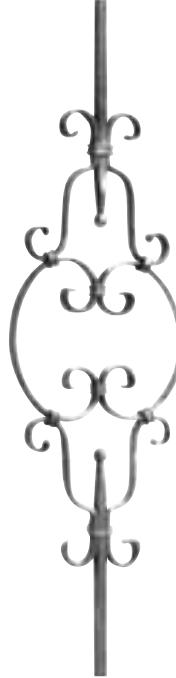
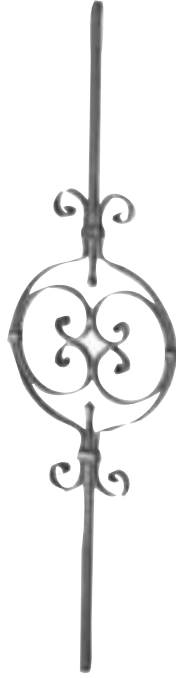

**Art. 469/1**  
Mtl 5/16" sq.  
W 5 3/4"  
H 35 7/16"  
Wt. 3.2 lbs.

**Art. 49/3**  
Mtl 1/2" sq.  
W 7 1/16"  
H 35 7/16"  
Wt. 5.6 lbs.

**Art. 64/A/1**  
Mtl 1/2" sq.  
W 9 7/8"  
H 35 7/16"  
Wt. 5.1 lbs.

**Art. 64/A/2**  
Mtl 1/2" sq.  
W 10 1/4"  
H 35 7/16"  
Wt. 5.0 lbs.

SUGGESTED NEWEL POSTS



**Art. 798/2**  
Mtl 1" sq.  
H 43"  
Wt. 11.4 lbs.

**Art. 639/5**  
Mtl 13/16" sq.  
H 47"  
Wt. 8.0 lbs.



Shown:146/4



**Art. 144/3**  
Mtl 1 3/16" dia.  
H 35 7/16"  
Wt. 2.2 lbs.



**Art. 146/1**  
Mtl 1 9/16" dia.  
H 35 7/16"  
Wt. 3.1 lbs.



**Art. 146/4**  
Mtl 1 9/16" dia.  
H 35 7/16"  
Wt. 3.3 lbs.



Shown:148/1



7/16"  
**Art. 149/1**  
Mtl 1 3/16" dia.  
H 35 7/16"  
Wt. 2.1 lbs.



9/16"  
**Art. 148/1**  
Mtl 1 3/16" dia.  
H 35 7/16"  
Wt. 2 lbs.



9/16"  
**Art. 148/2**  
Mtl 1 3/16" dia.  
H 35 7/16"  
Wt. 2.1 lbs.

SUGGESTED NEWEL POSTS



**Art. 145/3**  
Mtl 1 9/16" dia.  
H 39 3/8"  
Wt. 5.5 lbs.

**Art. 806/6**  
Mtl 1 9/16" dia.  
H 47"  
Wt. 4.5 lbs.



**Art. 537/1**  
Mtl 1 3/16" dia.  
H 39 3/8"  
Wt. 2.2 lbs.



**Art. 537/2**  
Mtl 1 3/16" dia.  
H 39 3/8"  
Wt. 2.2 lbs.



**Art. 537/3**  
Mtl 1 3/16" dia.  
H 39 3/8"  
Wt. 2.2 lbs.



**Art. 537/4**  
Mtl 1 3/16" dia.  
H 39 3/8"  
Wt. 2.2 lbs.



**Art. 537/5**  
Mtl 1 3/16" dia.  
H 39 3/8"  
Wt. 2.2 lbs.



**Art. 537/6**  
Mtl 1 3/16" dia.  
H 39 3/8"  
Wt. 2.2 lbs.



**Art. 537/7**  
Mtl 1 3/16" dia.  
H 39 3/8"  
Wt. 2.2 lbs.



**Art. 537/8**  
Mtl 1 3/16" dia.  
H 39 3/8"  
Wt. 2.2 lbs.



**Art. 537/9**  
Mtl 1 3/16" dia.  
H 39 3/8"  
Wt. 2.2 lbs.



Shown: 537/8

# Stair and Rail Balusters

**SUGGESTED NEWEL POSTS**









Steel tube with wooden bushing  
2 31/64" dia.

**Art. 806/6**  
Mtl 1 9/16" dia. H 47"  
Wt. 4.2 lbs.





Forged round post with wooden bushing  
2 3/4" dia.

**Art. 807/1**  
Mtl 1 3/16" dia. H 47"  
Wt. 16 lbs.

					
<b>Art. 1229/1</b> Mtl 1 3/16" dia. H 39 3/8" Wt. 2.2 lbs.	<b>Art. 1229/2</b> Mtl 1 3/16" dia. H 39 3/8" Wt. 2.2 lbs.	<b>Art. 1229/3</b> Mtl 1 3/16" dia. H 39 3/8" Wt. 2.2 lbs.	<b>Art. 1229/4</b> Mtl 1 3/16" dia. H 39 3/8" Wt. 2.2 lbs.	<b>Art. 1229/5</b> Mtl 1 3/16" dia. H 39 3/8" Wt. 2.2 lbs.	<b>Art. 1229/6</b> Mtl 1 3/16" dia. H 39 3/8" Wt. 2.2 lbs.



		
<b>Art. 533/8</b> Ceramic sphere	<b>Art. 745/5</b> Wood sphere	<b>Art. 531/2</b> Glass sphere
<b>Art. 533/4</b> Mtl 1 3/16" dia. H 35" Wt. 2.2 lbs.	<b>Art. 530/4</b> Mtl 1 3/16" dia. H 35 5/8" Wt. 2.1 lbs.	<b>Art. 531/1</b> Mtl 1 3/16" dia. H 35 7/16" Wt. 2.2 lbs.





Art. 1231/1  
Mtl 1 3/16" dia.  
H 39 3/8"  
Wt. 2.2 lbs.



Art. 1231/2  
Mtl 1 3/16" dia.  
H 39 3/8"  
Wt. 2.2 lbs.



Art. 1231/3  
Mtl 1 3/16" dia.  
H 39 3/8"  
Wt. 2.2 lbs.



Art. 1231/4  
Mtl 1 3/16" dia.  
H 39 3/8"  
Wt. 2.2 lbs.



Art. 1234/3  
Mtl 1 3/16" dia.  
H 35 7/16"  
Wt. 2.4 lbs.



Art. 1229/7  
Mtl 1 3/16" dia.  
H 19 3/8"  
Wt. 1.1 lbs.



Art. 1229/8  
Mtl 1 3/16" dia.  
H 15 3/8"  
Wt. 0.9 lbs.



Art. 1793/1  
(ex 8045/1)  
Mtl 2" dia.  
H 39 3/8"  
Wt. 5.3 lbs.



Art. 1793/2  
(ex 8045/1)  
Mtl 2" dia.  
H 39 3/8"  
Wt. 5.3 lbs.



Art. 1793/3  
(ex 8045/1)  
Mtl 2" dia.  
H 39 3/8"  
Wt. 5.3 lbs.



Art. 1793/4  
(ex 8045/4)  
Mtl 2" dia.  
H 39 3/8"  
Wt. 5.3 lbs.



Art. 525/1  
Mtl 1 3/16" dia.  
H 36 5/8"  
Wt. 2.6 lbs.

Brass bushing 160/D/12



Art. 527/2  
Mtl 1 3/16" dia.  
H 39 3/8"  
Wt. 2.6 lbs.

Brass bushing 747/7



Art. 527/3  
Mtl 1 3/16" dia.  
H 35 7/16"  
Wt. 2.6 lbs.

Brass bushing 747/4



Art. 160/17  
Mtl 1/2" dia.  
H 35 7/16"  
Wt. 2.2 lbs.

Brass 161/12-32



# Steel Balusters 47" inches



<b>Art. 1157/8</b> Mtl 1 3/16" dia. H 47" Wt. 2.5 lbs.	<b>Art. 1157/2</b> Mtl 9/16" sq. H 47" Wt. 4.1 lbs.	<b>Art. 1157/3</b> Mtl 9/16" sq. H 47" Wt. 4.1 lbs.	<b>Art. 1157/1</b> Mtl 9/16" sq. H 47" Wt. 4.1 lbs.	<b>Art. 1157/5</b> Mtl 9/16" sq. W 4 5/16" H 47" Wt. 5.1 lbs.	<b>Art. 1157/4</b> Mtl 9/16" sq. W 5 1/2" H 47" Wt. 4.4 lbs.	<b>Art. 1159/11</b> Mtl 1/2" sq. H 47" Wt. 3.0 lbs.	<b>Art. 1159/12</b> Mtl 1/2" sq. H 47" Wt. 3.0 lbs.
---	--	--	--	---	--	--	--

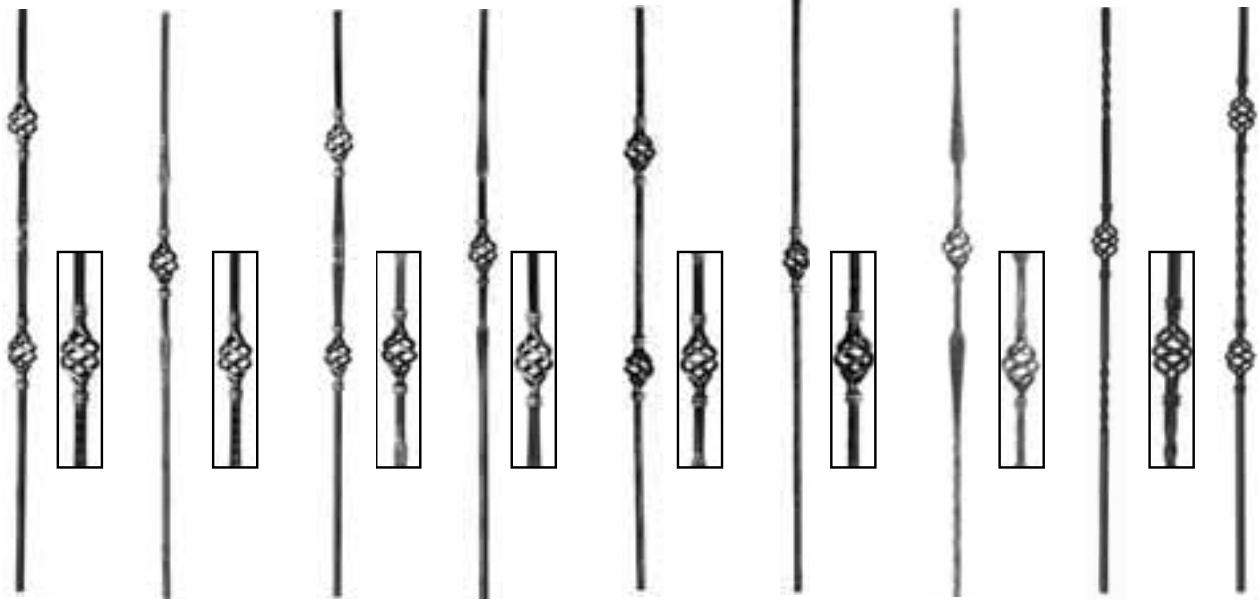

<b>Art. 1158/12</b> Mtl 1/2" sq. W 2 1/8" H 47" Wt. 4.3 lbs.	<b>Art. 1158/13</b> Mtl 1/2" sq. W 2 1/8" H 47" Wt. 4.3 lbs.	<b>Art. 1158/14</b> Mtl 1/2" sq. W 2 1/8" H 47" Wt. 4.3 lbs.	<b>Art. 1158/15</b> Mtl 1/2" sq. W 2 1/8" H 47" Wt. 4.1 lbs.	<b>Art. 1158/16</b> Mtl 1/2" sq. W 2 1/8" H 47" Wt. 4.3 lbs.	<b>Art. 1158/17</b> Mtl 1/2" sq. W 2 1/8" H 47" Wt. 4.1 lbs.	<b>Art. 562/2/L</b> Mtl 9/16" sq. H 47" Wt. 4.4 lbs.	<b>Art. 1158/1</b> Mtl 1/2" sq. W 2 1/8" H 47" Wt. 3.2 lbs.	<b>Art. 1158/2</b> Mtl 1/2" sq. W 2 1/8" H 47" Wt. 3.3 lbs.
--	--	--	--	--	--	---	---	---



<b>Art. 1158/3</b> Mtl 1/2" sq. W 2 1/8" H 47" Wt. 3.2 lbs.	<b>Art. 1158/4</b> Mtl 1/2" sq. W 2 1/8" H 47" Wt. 3.2 lbs.	<b>Art. 64/L/4/L</b> Mtl 9/16" sq. H 47" Wt. 3.2 lbs.	<b>Art. 64/L/3/L</b> Mtl 9/16" sq. H 47" Wt. 3.2 lbs.	<b>Art. 1158/9</b> Mtl 9/16" sq. H 47" Wt. 4.6 lbs.	<b>Art. 1158/10</b> Mtl 9/16" sq. H 47" Wt. 4.1 lbs.	<b>Art. 1159/10</b> Mtl 1/2" sq. W 5 1/2" H 47" Wt. 3.6 lbs.	<b>Art. 1159/9</b> Mtl 1/2" sq. W 5 1/2" H 47" Wt. 4.2 lbs.	<b>Art. 1160/6</b> Mtl 1/2" sq. W 7 1/2" H 47" Wt. 4.8 lbs.
---	---	--	--	--	---	--	---	---

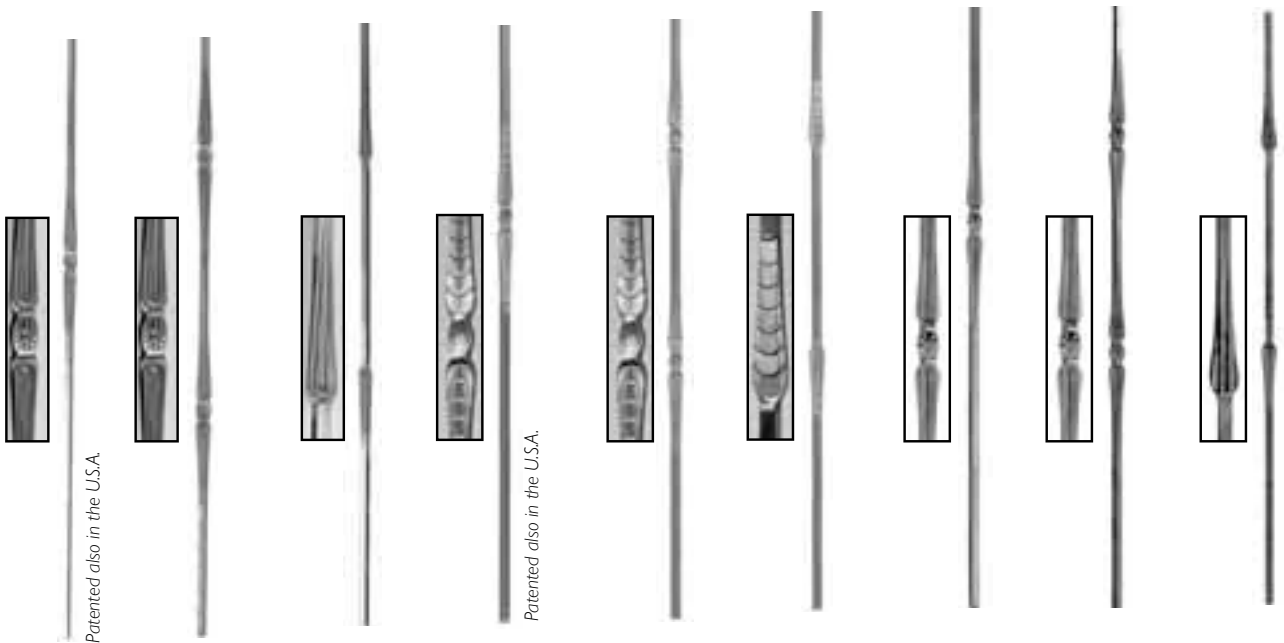

Patented also in the U.S.A.

Patented also in the U.S.A.

<b>Art. 1156/1</b> Mtl 9/16" sq. H 47" Wt. 4.1 lbs.	<b>Art. 1156/2</b> Mtl 9/16" sq. H 47" Wt. 4.1 lbs.	<b>Art. 1156/3</b> Mtl 9/16" sq. H 47" Wt. 4.1 lbs.	<b>Art. 1156/4</b> Mtl 9/16" sq. H 47" Wt. 4.1 lbs.	<b>Art. 1156/5</b> Mtl 9/16" sq. H 47" Wt. 4.1 lbs.	<b>Art. 1156/6</b> Mtl 9/16" sq. H 47" Wt. 4.1 lbs.	<b>Art. 1156/7</b> Mtl 9/16" sq. H 47" Wt. 4.1 lbs.	<b>Art. 1156/8</b> Mtl 9/16" sq. H 47" Wt. 4.1 lbs.	<b>Art. 1156/9</b> Mtl 9/16" sq. H 47" Wt. 4.1 lbs.
--	--	--	--	--	--	--	--	--

Steel Balusters 47" inches

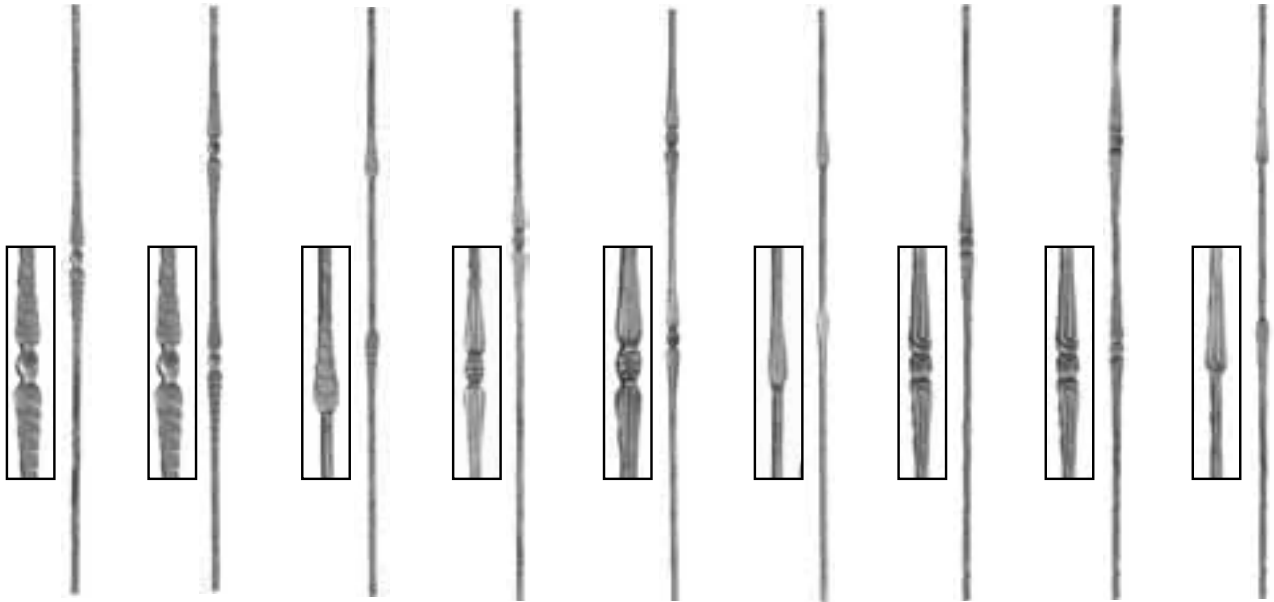

Art. 1156/10	Art. 1156/11	Art. 1156/12	Art. 1156/13	Art. 1156/14	Art. 1156/15	Art. 1156/16	Art. 1156/17	Art. 1156/18
Mtl 9/16" sq.	Mtl 9/16" sq.	Mtl 9/16" sq.	Mtl 9/16" sq.	Mtl 9/16" sq.	Mtl 9/16" sq.	Mtl 9/16" sq.	Mtl 9/16" sq.	Mtl 9/16" sq.
H 47"	H 47"	H 47"	H 47"	H 47"	H 47"	H 47"	H 47"	H 47"
Wt. 4.1 lbs.	Wt. 4.1 lbs.	Wt. 4.1 lbs.	Wt. 4.1 lbs.	Wt. 4.1 lbs.	Wt. 4.1 lbs.	Wt. 4.1 lbs.	Wt. 4.1 lbs.	Wt. 4.1 lbs.



Cast iron bushing art. 746/1 1 9/16" sq.

Art. 1160/1  
Mtl 1/2" sq.  
H 47"  
Wt. 3.3 lbs.



Cast iron bushing art. 746/1 1 9/16" sq.

Art. 1160/2  
Mtl 1/2" sq.  
H 47"  
Wt. 3.3 lbs.



Art. 1160/4  
Mtl 9/16" sq.  
H 47"  
Wt. 4.0 lbs.



Hammered edges

Art. 597/3/L  
Mtl 9/16" sq.  
H 47"  
Wt. 3.3 lbs.



Shown: 597/3/L

# Hammered Stair and Rail Balusters

Patented also in the U.S.A.



Art. 1701/2  
(ex 8027/2)  
Mtl 9/16" sq.  
H 39 3/8"  
Wt. 3.4 lbs.



Art. 1701/4  
(ex 8027/4)  
Mtl 9/16" sq.  
H 39 3/8"  
Wt. 3.4 lbs.



Art. 1701/6  
(ex 8027/6)  
Mtl 9/16" sq.  
H 39 3/8"  
Wt. 3.4 lbs.



Art. 1701/8  
(ex 8027/24)  
Mtl 9/16" sq.  
W 5 3/4"  
H 39 3/8"  
Wt. 4.2 lbs.



Art. 1733/12  
(ex 9111/1)  
Mtl 9/16" sq.  
H 39 3/8"  
Wt. 3.6 lbs.



Art. 1733/10  
(ex 9111/2)  
Mtl 9/16" sq.  
H 39 3/8"  
Wt. 3.5 lbs.



Art. 1701/10  
(ex 8027/26)  
Mtl 9/16" sq.  
W 6 7/8"  
H 39 3/8"  
Wt. 4.9 lbs.



Art. 1701/12  
(ex 8027/28)  
Mtl 9/16" sq.  
W 5 3/4"  
H 39 3/8"  
Wt. 5.3 lbs.

Patented also in the U.S.A.



Art. 1702/2  
(ex 8027/11)  
Mtl 9/16" sq.  
H 39 3/8"  
Wt. 3.4 lbs.



Art. 1702/4  
(ex 8027/13)  
Mtl 9/16" sq.  
H 39 3/8"  
Wt. 3.4 lbs.



Art. 1702/6  
(ex 8027/15)  
Mtl 9/16" sq.  
H 39 3/8"  
Wt. 3.4 lbs.



Art. 1702/8  
(ex 8027/18)  
Mtl 9/16" sq.  
W 5 11/16"  
H 39 3/8"  
Wt. 4.2 lbs.



Art. 1702/10  
(ex 8027/20)  
Mtl 9/16" sq.  
W 5 11/16"  
H 39 3/8"  
Wt. 4.9 lbs.



Art. 1702/12  
(ex 8027/30)  
Mtl 9/16" sq.  
W 6 7/8"  
H 39 3/8"  
Wt. 4.9 lbs.



Art. 1705/2  
(ex 8028/2)  
Mtl 9/16" sq.  
H 39 3/8"  
Wt. 3.4 lbs.

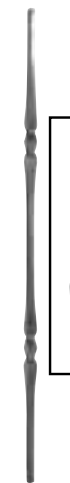

Art. 1705/4  
(ex 8028/4)  
Mtl 9/16" sq.  
H 39 3/8"  
Wt. 3.4 lbs.



Art. 1705/6  
(ex 8028/6)  
Mtl 9/16" sq.  
H 39 3/8"  
Wt. 3.4 lbs.



Art. 1705/8  
(ex 8028/8)  
Mtl 9/16" sq.  
W 5 11/16"  
H 39 3/8"  
Wt. 4.2 lbs.



Art. 1705/10  
(ex 8028/10)  
Mtl 9/16" sq.  
W 6 7/8"  
H 39 3/8"  
Wt. 4.9 lbs.



Art. 1705/12  
(ex 8028/12)  
Mtl 9/16" sq.  
W 5 11/16"  
H 39 3/8"  
Wt. 4.9 lbs.



Art. 1710/2  
(ex 9114/7)  
Mtl 9/16" sq.  
H 39 3/8"  
Wt. 3.4 lbs.



Art. 1710/4  
(ex 9114/8)  
Mtl 9/16" sq.  
H 39 3/8"  
Wt. 3.4 lbs.

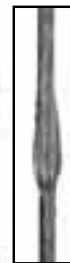

Art. 1710/6  
(ex 9114/9)  
Mtl 9/16" sq.  
H 39 3/8"  
Wt. 3.4 lbs.



Art. 1710/8  
(ex 9114/10)  
Mtl 9/16" sq.  
H 39 3/8"  
Wt. 4.4 lbs.

# Hammered Stair and Rail Balusters



Art. 1710/10  
(ex 9114/11)  
Mtl 9/16" sq.  
H 39 3/8"  
Wt. 4.4 lbs.



Art. 1710/12  
(ex 9114/12)  
Mtl 9/16" sq.  
H 39 3/8"  
Wt. 4.4 lbs.



Art. 1730/2  
(ex 8029/2)  
Mtl 9/16" sq.  
H 39 3/8"  
Wt. 3.4 lbs.



Art. 1730/4  
(ex 8028/4)  
Mtl 9/16" sq.  
H 39 3/8"  
Wt. 3.4 lbs.



Art. 1730/6  
(ex 8028/6)  
Mtl 9/16" sq.  
H 39 3/8"  
Wt. 3.4 lbs.



Art. 1730/8  
(ex 8028/8)  
Mtl 9/16" sq.  
H 39 3/8"  
Wt. 3.4 lbs.



Art. 1710/14  
(ex 9115/1)  
Mtl 9/16" sq.  
H 39 3/8"  
Wt. 3.4 lbs.



Art. 1710/16  
(ex 9115/2)  
Mtl 9/16" sq.  
H 39 3/8"  
Wt. 3.4 lbs.



Art. 1710/18  
(ex 9115/3)  
Mtl 9/16" sq.  
H 39 3/8"  
Wt. 3.4 lbs.



Art. 1710/20  
(ex 9115/4)  
Mtl 9/16" sq.  
H 39 3/8"  
Wt. 4.4 lbs.



Art. 1710/22  
(ex 9115/5)  
Mtl 9/16" sq.  
H 39 3/8"  
Wt. 4.4 lbs.



Art. 1710/24  
(ex 9115/6)  
Mtl 9/16" sq.  
H 39 3/8"  
Wt. 4.4 lbs.



Art. 1713/2  
(ex 9114/1)  
Mtl 9/16" sq.  
H 39 3/8"  
Wt. 3.4 lbs.



Art. 1713/4  
(ex 9114/2)  
Mtl 9/16" sq.  
H 39 3/8"  
Wt. 3.4 lbs.



Art. 1713/6  
(ex 9114/3)  
Mtl 9/16" sq.  
H 39 3/8"  
Wt. 3.4 lbs.



Art. 1713/8  
(ex 9114/4)  
Mtl 9/16" sq.  
H 39 3/8"  
Wt. 4.4 lbs.



Art. 1713/10  
(ex 9114/5)  
Mtl 9/16" sq.  
H 39 3/8"  
Wt. 4.4 lbs.



Art. 1713/12  
(ex 9114/6)  
Mtl 9/16" sq.  
H 39 3/8"  
Wt. 4.4 lbs.



Art. 1716/14  
(ex 9114/7)  
Mtl 9/16" dia.  
H 39 3/8"  
Wt. 3.4 lbs.



Art. 1716/16  
(ex 9114/8)  
Mtl 9/16" dia.  
H 39 3/8"  
Wt. 3.4 lbs.



Art. 1716/18  
(ex 9114/9)  
Mtl 9/16" dia.  
H 39 3/8"  
Wt. 3.4 lbs.



Art. 1716/20  
(ex 9114/10)  
Mtl 9/16" dia.  
H 39 3/8"  
Wt. 4.4 lbs.



Art. 1716/22  
(ex 9114/11)  
Mtl 9/16" dia.  
H 39 3/8"  
Wt. 4.4 lbs.



Art. 1716/24  
(ex 9114/12)  
Mtl 9/16" dia.  
H 39 3/8"  
Wt. 4.4 lbs.





Art. 1729/2  
(ex 9116/1)  
Mtl 9/16" sq.  
H 39 3/8"  
Wt. 3.6 lbs.



Art. 1729/4  
(ex 9116/2)  
Mtl 9/16" sq.  
H 39 3/8"  
Wt. 3.5 lbs.



Art. 1729/6  
(ex 9116/3)  
Mtl 9/16" sq.  
H 39 3/8"  
Wt. 5.1 lbs.



Art. 1729/8  
(ex 9116/4)  
Mtl 9/16" sq.  
H 39 3/8"  
Wt. 3.1 lbs.



Art. 1729/10  
(ex 9116/5)  
Mtl 9/16" sq.  
H 39 3/8"  
Wt. 3.4 lbs.



Art. 1729/12  
(ex 9116/6)  
Mtl 9/16" sq.  
H 39 3/8"  
Wt. 3.4 lbs.



Art. 1131/3  
Mtl 9/16" sq.  
W 5 1/8"  
H 39 3/8"  
Wt. 3.5 lbs.



Art. 1055/2  
Mtl 1/2" sq.  
H 4 1/2"  
H 39 3/8"  
Wt. 2.4 lbs.



Art. 615/2  
W 4 3/4"  
H 35 7/16"  
Wt. 2.8 lbs.



Art. 615/3  
W 4 15/16"  
H 35 7/16"  
Wt. 2.3 lbs.



Art. 615/4  
W 2 3/4"  
H 35 7/16"  
Wt. 2.1 lbs.



Art. 617/1  
W 3 9/16"  
H 35 7/16"  
Wt. 1.8 lbs.



Art. 617/2  
W 3 9/16"  
H 35 7/16"  
Wt. 1.9 lbs.



Art. 617/3  
W 4 3/4"  
H 35 7/16"  
Wt. 1.8 lbs.



Art. 617/4  
W 4 3/4"  
H 35 7/16"  
Wt. 1.9 lbs.



Art. 617/5  
W 4 3/4"  
H 35 7/16"  
Wt. 3.1 lbs.



Art. 615/1  
W 5 7/8"  
H 35 7/16"  
Wt. 2.8 lbs.



Art. 617/6  
H 35 7/16"  
Wt. 1.9 lbs.



Art. 617/7  
H 35 7/16"  
Wt. 1.7 lbs.



Art. 1068/1  
Mtl 1/2" dia.  
W 6 7/8"  
H 39 3/8"  
Wt. 5.1 lbs.



Art. 1068/2  
Mtl 1/2" dia.  
W 6 7/8"  
H 39 3/8"  
Wt. 5.1 lbs.



Art. 1068/3  
Mtl 1/2" dia.  
W 6 7/8"  
H 39 3/8"  
Wt. 5.1 lbs.



Art. 1068/4  
Mtl 1/2" dia.  
W 6 7/8"  
H 39 3/8"  
Wt. 5.1 lbs.

# Stair and Rail Balusters



- |                    |                    |                    |                    |                    |                    |                    |                    |                    |
|--------------------|--------------------|--------------------|--------------------|--------------------|--------------------|--------------------|--------------------|--------------------|
| <b>Art. 1054/4</b> | <b>Art. 1054/5</b> | <b>Art. 1054/6</b> | <b>Art. 1053/1</b> | <b>Art. 1089/3</b> | <b>Art. 1089/4</b> | <b>Art. 1097/3</b> | <b>Art. 1115/1</b> | <b>Art. 1115/2</b> |
| Mtl 1/2" dia.      | Mtl 1/2" dia.      | Mtl 1/2" dia.      | Mtl 15/16" x 1/2"  | Mtl 1/2" sq.       | Mtl 1/2" sq.       | Mtl 1/2" sq.       | Mtl 1/2" sq.       | Mtl 1/2" sq.       |
| W 4 5/16"          | W 8 9/32"          | W 4 5/16"          | W 14 5/32"         | W 3 15/16"         | W 6 1/2"           | W 4 1/8"           | W 4 1/8"           | W 4 1/8"           |
| H 39 3/8"          | H 39 3/8"          | H 39 3/8"          | H 39 3/8"          | H 39 3/8"          | H 39 3/8"          | H 39 3/8"          | H 39 3/8"          | H 39 3/8"          |
| Wt. 2.9 lbs.       | Wt. 2.9 lbs.       | Wt. 2.5 lbs.       | Wt. 7.3 lbs.       | Wt. 3.3 lbs.       | Wt. 4 lbs.         | Wt. 3.1 lbs.       | Wt. 2.6 lbs.       | Wt. 2.8 lbs.       |

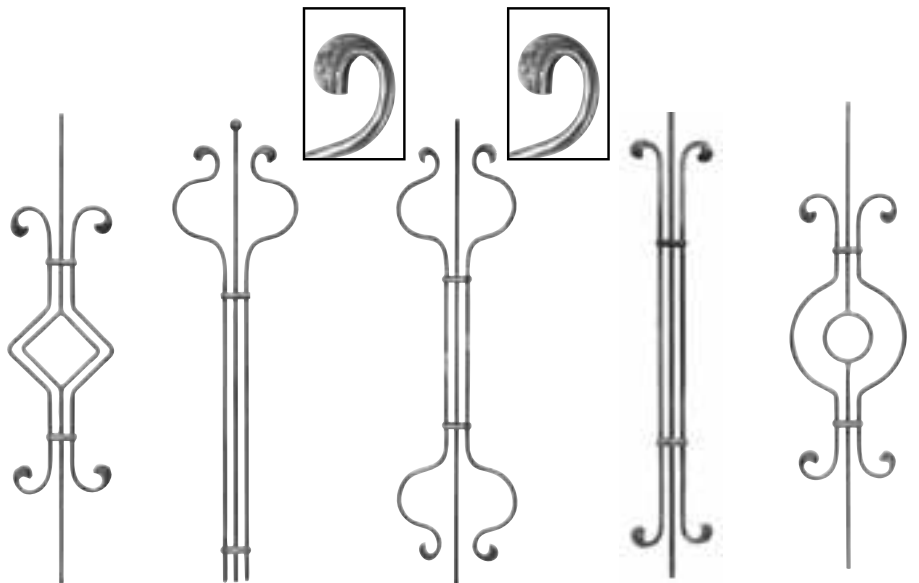

- |                    |                    |                    |                    |                    |
|--------------------|--------------------|--------------------|--------------------|--------------------|
| <b>Art. 1074/1</b> | <b>Art. 1075/1</b> | <b>Art. 1075/2</b> | <b>Art. 1073/3</b> | <b>Art. 1074/2</b> |
| Mtl 3/8" dia.      | Mtl 3/8" dia.      | Mtl 3/8" dia.      | Mtl 3/8" dia.      | Mtl 3/8" dia.      |
| W 8 1/16"          | W 9 5/8"           | W 9 5/8"           | W 6 5/16"          | W 9 1/16"          |
| H 39 3/8"          | H 39 3/8"          | H 39 3/8"          | H 39 3/8"          | H 39 3/8"          |
| Wt. 4.1 lbs.       | Wt. 4.6 lbs.       | Wt. 4.5 lbs.       | Wt. 3.8 lbs.       | Wt. 4.0 lbs.       |



- |                    |                    |
|--------------------|--------------------|
| <b>Art. 1141/1</b> | <b>Art. 1141/2</b> |
| Mtl 15/16" x 1/2"  | Mtl 15/16" x 1/2"  |
| W 7 11/16"         | W 7 11/16"         |
| H 39 3/8"          | H 39 3/8"          |
| Wt. 7.7 lbs.       | Wt. 7.7 lbs.       |





**BELLY PICKETS**

Quick Reference # 7 2011

Balcony Elements



Art. GD0021/Q20  
Mtl 3/4" sq.  
W 11 39/64" approx  
H 35 53/64" approx  
Wt. 10 lbs.

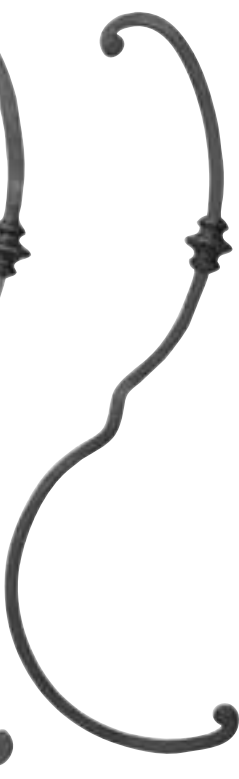

Art. GD0021/Q16  
Mtl 5/8" sq.  
W 11 39/64" approx  
H 35 53/64" approx  
Wt. 6.8 lbs.



Art. 578/15  
Mtl 9/16" sq.  
H 35 7/16"  
Wt. 3.0 lbs.

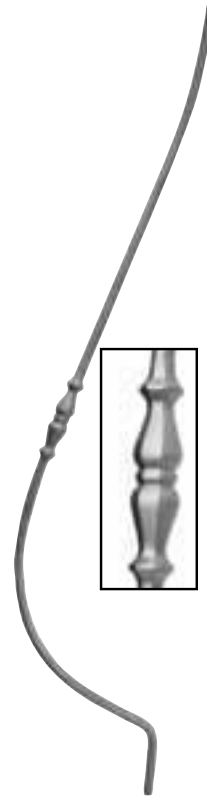

Art. 1783/3  
Mtl 1/2" dia.  
H 35 7/16"  
Wt. 3.4 lbs.

Hot Forged

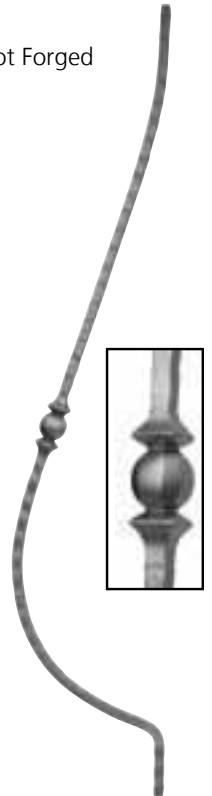

Art. 1783/5  
Mtl 1/2" sq.  
H 35 7/16"  
Wt. 3.4 lbs.

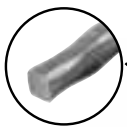

Art. 47/11  
Mtl 9/16" sq.  
W 2 1/8"  
H 35 7/16"  
Wt. 3.3 lbs.



Art. 47/10  
Mtl 9/16" sq.  
H 35 7/16"  
Wt. 3.0 lbs.



Art. 47/12  
Mtl 1/2" sq.  
H 35 7/16"  
Wt. 3.1 lbs.



Art. 47/9  
Mtl 1/2" sq.  
H 35 7/16"  
Wt. 3.4 lbs.



Art. 64/D/4  
Mtl 1/2" sq.  
H 35 7/16"  
Wt. 2.3 lbs.



Art. 1782/1  
(ex 9121/1)  
Mtl 9/16" sq.  
H 39 3/8"  
Wt. 4.1 lbs.



Art. 70/D/5  
Mtl 9/16" sq.  
H 35 7/16"  
Wt. 3.4 lbs.



Art. 64/H/2  
Mtl 9/16" sq.  
H 35 7/16"  
Wt. 3.0 lbs.



Art. 64/H/4  
Mtl 9/16" sq.  
W 1 3/16"  
H 35 7/16"  
Wt. 2.9 lbs.



Art. 64/H/6  
Mtl 9/16" sq.  
W 5 1/2"  
H 35 7/16"  
Wt. 3.5 lbs.



Art. 64/H/10  
Mtl 9/16" sq.  
W 1 3/16"  
H 35 7/16"  
Wt. 3.1 lbs.



Art. 64/H/8  
Mtl 9/16" sq.  
W 8 7/8"  
H 35 7/16"  
Wt. 5.5 lbs.



Art. 1782/7  
(ex 8033/2)  
Mtl 9/16" sq.  
W 8 1/4"  
H 39 3/8"  
Wt. 5.8 lbs.



Art. 1782/8  
(ex 8033/3)  
Mtl 9/16" sq.  
W 8 1/4"  
H 39 3/8"  
Wt. 6.2 lbs.



Art. 1782/8  
(ex 8033/3)  
Mtl 9/16" sq.  
W 9 7/8"  
H 39 3/8"  
Wt. 6.8 lbs.

Shown: 44/12



ARTEFERRO

Hammered on 4 corners



**Art. 44/12**  
Mtl 1 9/16" x 5/16"  
H 39 3/8"  
Wt. 7.7 lbs.



**Art. 1791/1**  
(ex 8032/1)  
Mtl 1 9/16" x 5/16"  
H 39 3/8"  
Wt. 5.7 lbs.



**Art. 1785/4**  
(ex 8032/5)  
Mtl 1 3/16" x 3/16"  
H 37 13/32"  
Wt. 5.7 lbs.



**Art. 46/6**  
Mtl 1 9/16" x 5/32"  
H 31 1/2"  
Wt. 3.2 lbs.



**Art. 1789/5**  
(ex 9120/1)  
Mtl 1 7/32" x 3/16"  
H 31 1/2"  
Wt. 1.9 lbs.



**Art. 1789/1**  
(ex 9120/2)  
Mtl 1 7/32" x 3/16"  
H 31 1/2"  
Wt. 1.6 lbs.



**Art. 1789/3**  
(ex 9120/3)  
Mtl 1 7/32" x 3/16"  
H 31 1/2"  
Wt. 1.1 lbs.



**Art. 1789/4**  
(ex 9120/4)  
Mtl 1 7/32" x 3/16"  
H 31 1/2"  
Wt. 1.9 lbs.

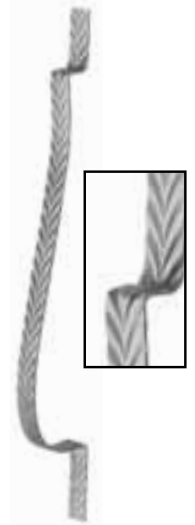

**Art. 1789/2**  
(ex 9120/5)  
Mtl 1 1/4" x 3/16"  
H 31 1/2"  
Wt. 2.0 lbs.

Shown: 1702/14



**Art. 47/1**  
Mtl 1/2" sq.  
W 6 5/16"  
H 35 7/16"  
Wt. 3.4 lbs.



ARTEFERRO

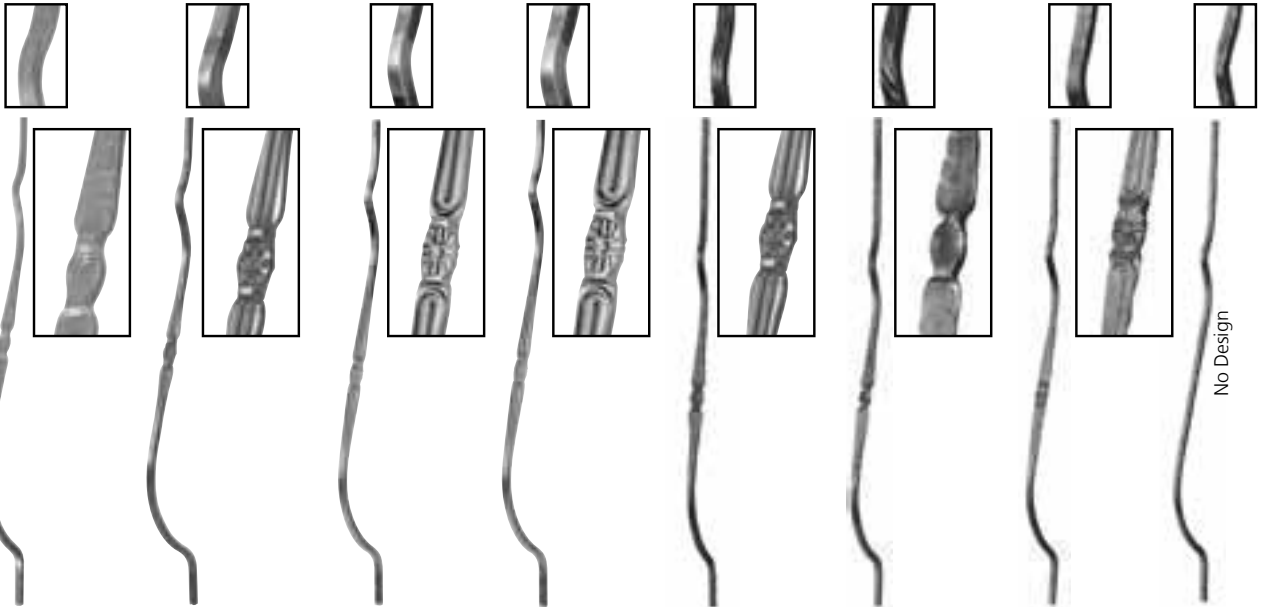

No Design

**Art. 1702/14**  
(ex 8027/22)  
Mtl 9/16" sq.  
H 39 3/8"  
Wt. 3.6 lbs.

**Art. 1705/14**  
(ex 8028/14)  
Mtl 9/16" sq.  
H 39 3/8"  
Wt. 3.6 lbs.

**Art. 1701/14**  
(ex 8027/8)  
Mtl 9/16" sq.  
H 39 3/8"  
Wt. 3.6 lbs.

**Art. 1779/14**  
(ex 9121/2)  
Mtl 9/16" sq.  
H 39 3/8"  
Wt. 3.6 lbs.

**Art. 1780/10**  
(ex 9121/3)  
Mtl 9/16" sq.  
H 39 3/8"  
Wt. 3.6 lbs.

**Art. 1780/12**  
(ex 9121/4)  
Mtl 9/16" sq.  
H 39 3/8"  
Wt. 3.6 lbs.

**Art. 1780/14**  
(ex 9121/5)  
Mtl 9/16" sq.  
H 39 3/8"  
Wt. 3.6 lbs.

**Art. 1780/16**  
(ex 9121/6)  
Mtl 9/16" sq.  
H 39 3/8"  
Wt. 3.6 lbs.



Shown: 46/6



ARTEFERRO

Shown: 47/10



ARTEFERRO

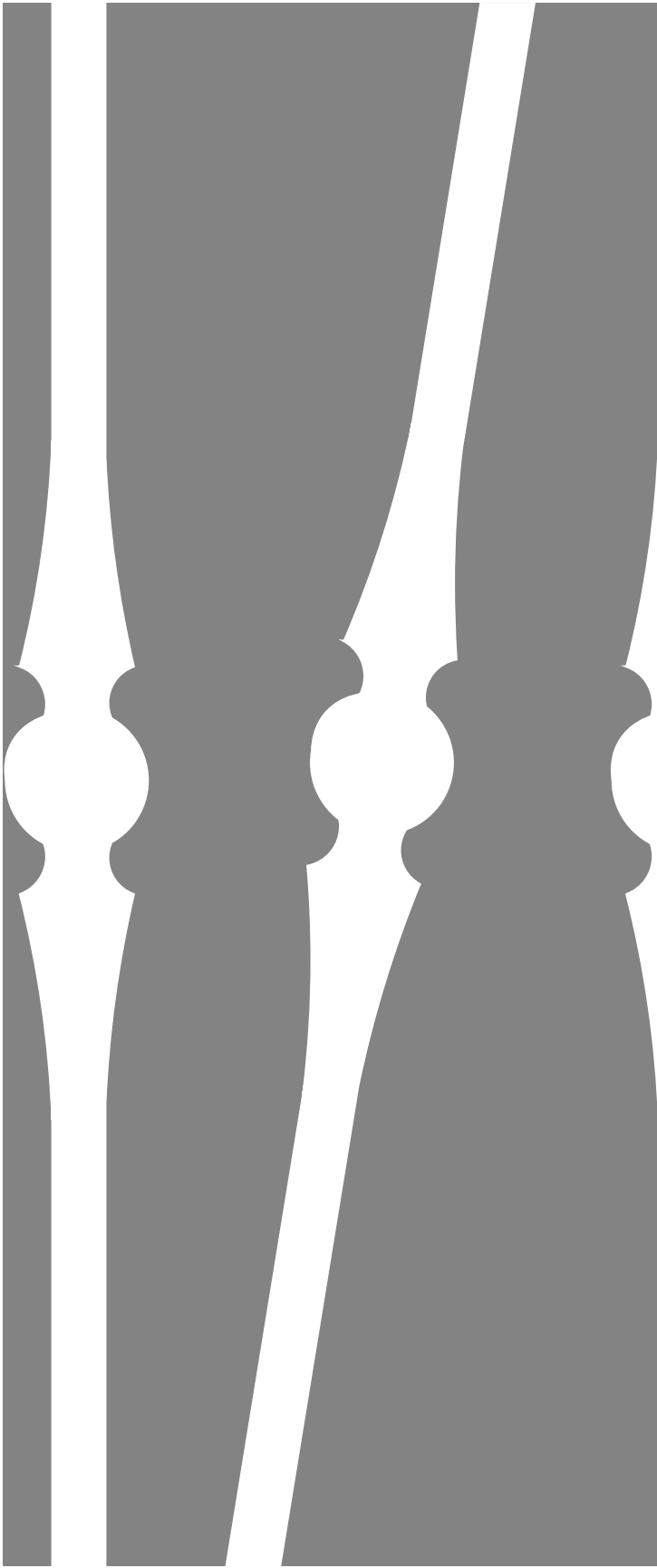

## NEWEL POSTS

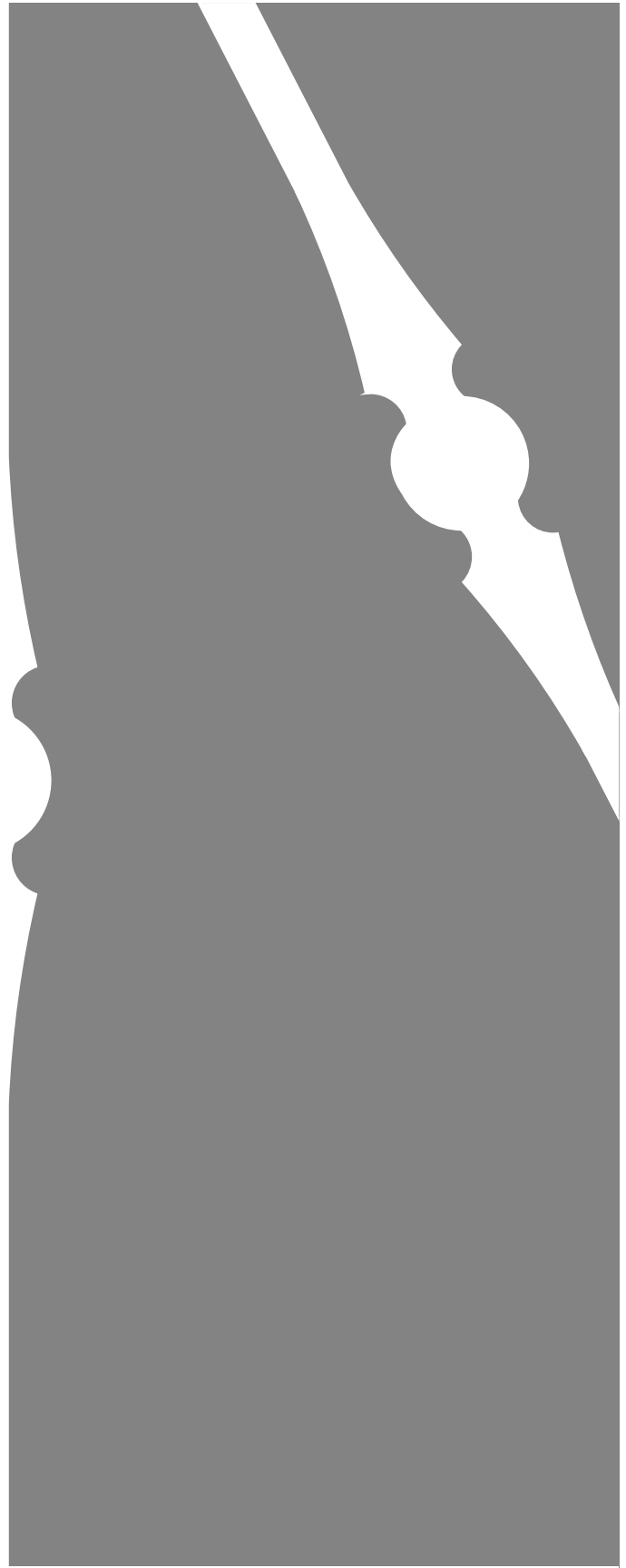

Quick Reference # 7 2011





Balusters: 1160/8, 488/1

Art. 1206/1  
Mtl 1 3/16" sq.  
W 10 5/8" x H 47"  
Wt. 24.2 lbs.



Balusters: 505/3, 505/4, 105/3, 105/4

Art. 799/1  
Mtl 1" sq.  
H 43 5/16"  
Wt. 17.16 lbs.



Art. 112/B/9  
Mtl 25/32" sq.  
H 42"  
Wt. 8.0 lbs.



Art. 639/5  
Mtl 13/16" sq.  
H 47"  
Wt. 8.0 lbs.

Shown: 112/B/9



Shown: 799/1



Shown: 112/9



ARTEFERRO



Balusters: 505/3, 505/4

Art. 798/2  
Mtl 1" sq.  
H 43"  
Wt. 11.4 lbs.



Balusters: 110/3, 110/5

Art. 112/9  
Mtl 1 3/16" sq.  
H 47"  
Wt. 14.1 lbs.



Balusters: 108/A/1, 108/A/2

Art. 112/10  
Mtl 1 3/16" sq.  
H 47"  
Wt. 14.3 lbs.



Balusters: 497/1, 497/2

Art. 112/11  
Mtl 1 3/16" sq.  
H 47"  
Wt. 14.3 lbs.

Shown: 112/7



ARTEFERRO



Balusters: 105/1, 105/2

Art. 112/7  
Mtl 1" sq.  
H 47"  
Wt. 14.5 lbs.



Balusters: 98/1

Art. 112/5  
Mtl 1" sq.  
H 47"  
Wt. 12.5 lbs.  
Art. 799/3  
Mtl 1 9/16" sq.  
H 47"  
Wt. 37.4 lbs.



Balusters: 50/5, 50/6, 50/7, 50/8

Art. 113/5  
Mtl 3/4" sq.  
H 43"  
Wt. 8.4 lbs.  
Art. 113/6  
Mtl 1 3/16" sq.  
H 43"  
Wt. 17 lbs.



Match for twisted bars

Art. 113/7  
Mtl 3/4" sq.  
H 43"  
Wt. 13 lbs.  
Art. 113/8  
Mtl 1 3/16" sq.  
H 43"  
Wt. 15 lbs.

Newel Posts

Shown: 797/2



Art. 1775/13  
(ex 9147/1)  
Mtl 1" sq.  
H 47"  
Wt. 13 lbs.

Art. 1775/14  
(ex 9147/3)  
Mtl 1 3/16" sq.  
H 47"  
Wt. 18.7 lbs.



Balusters: 1159/5, 1159/6, 105/1, 105/2

Art. 1775/15  
Mtl 1" sq.  
H 47"  
Wt. 13 lbs.



Balusters: 576/1, 576/2

Art. 801/5  
Mtl 1" dia.  
H 47"  
Wt. 11 lbs.



Art. GD0029  
Mtl 1 3/16" sq.  
H 51 3/16"  
Wt. 20.3 lbs.



Balusters: 499/1, 499/2

Art. 797/2  
Mtl 1 3/16" dia.  
H 47"  
Wt. 11.5 lbs.

Art. 797/7  
Mtl 1 9/16" dia.  
H 47"  
Wt. 29 lbs.



Balusters: 118/H/1

Art. 112/3  
Mtl 1" sq.  
H 47"  
Wt. 14 lbs.



Balusters: 64/F/3, 64/F/5, 64/F/7, 64/F/9, 64/G/2

Art. 64/F/1  
Mtl 1" sq.  
H 47"  
Wt. 13 lbs.



Balusters: 64/I/3, 64/I/4

Art. 64/I/1  
Mtl 1" sq.  
H 47"  
Wt. 14.7 lbs.



Shown: 802/1, 118H/1, 488/1



ARTEFERRO

## Newel Posts



Balusters: 118/H/1, 118/H/2, 488/1

**Art. 802/1**  
Mtl 1 3/16" sq.  
W 13 3/4"  
H 39 3/8"  
Wt. 37.8 lbs.



**Art. 802/2**  
Mtl 1" x 1/2"  
W 10 5/8"  
H 25 5/8"  
Wt. 15.8 lbs.



Balusters: 48/1, 48/2

**Art. 113/1**  
Mtl 3/4" sq.  
H 43"  
Wt. 8 lbs.  
**Art. 113/2**  
Mtl 1 3/16" sq.  
H 43"  
Wt. 17.6 lbs.



Balusters: 48/3, 48/4

**Art. 113/3**  
Mtl 3/4" sq.  
H 43"  
Wt. 8 lbs.  
**Art. 113/4**  
Mtl 1 3/16" sq.  
H 43"  
Wt. 20 lbs.

Newel Posts



Art. 1207/1  
Mtl 2 3/8" sq.  
W 3 11/32"  
H 47"  
Wt. 26.4 lbs.



Art. 1207/2  
Mtl 3 5/32" sq.  
W 4 1/8"  
H 47"  
Wt. 33 lbs.



Art. 1207/3  
Mtl 2 15/16" dia.  
W 3 15/16"  
H 47"  
Wt. 24 lbs.



Art. 1207/4  
Mtl 2 15/16" dia.  
W 5 5/16"  
H 47"  
Wt. 29.7 lbs.

Shown: 1207/2



Match for balusters:  
1167/1, 1167/2, 1167/3, 1167/4

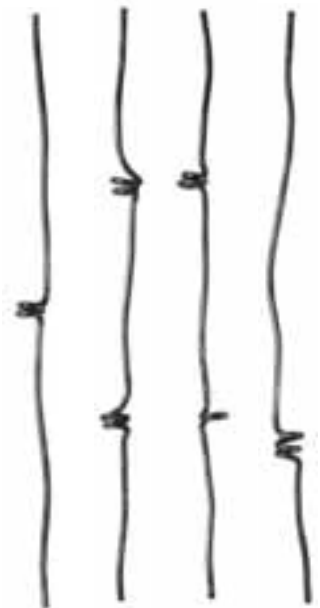



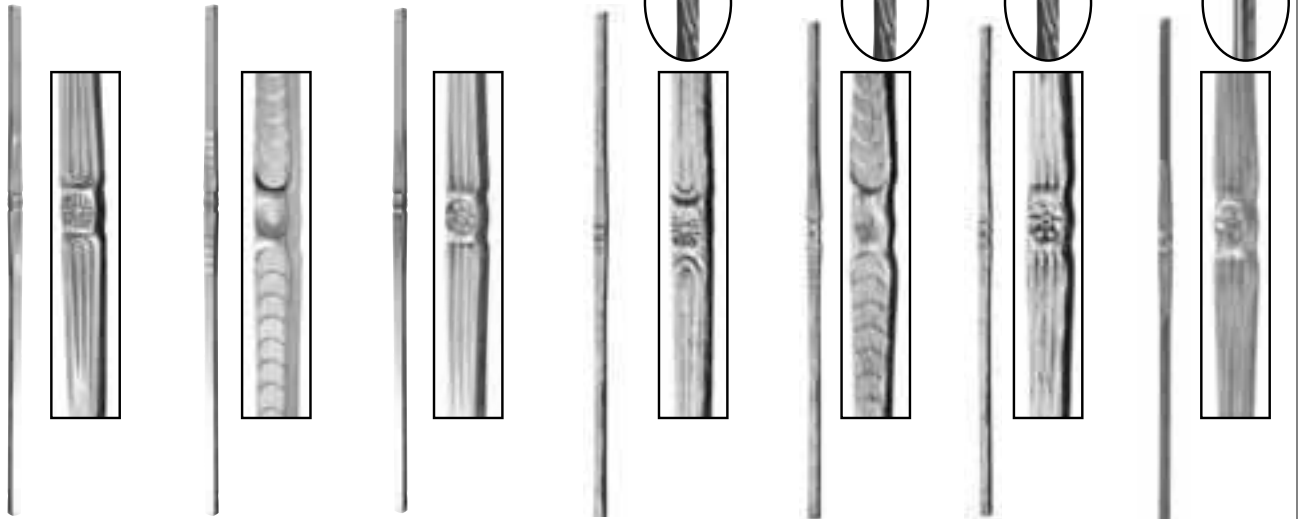

**Art. 1701/15**  
(ex 8027/9)  
Mtl 1" sq.  
H 47"  
Wt. 13 lbs.

**Art. 1702/15**  
(ex 8027/16)  
Mtl 1" sq.  
H 47"  
Wt. 13 lbs.

**Art. 1705/15**  
(ex 8028/15)  
Mtl 1" sq.  
H 47"  
Wt. 13 lbs.

**Art. 1777/6**  
(ex 9146/1)  
Mtl 1" sq.  
H 47"  
Wt. 13 lbs.

**Art. 1777/5**  
(ex 9146/2)  
Mtl 1" sq.  
H 47"  
Wt. 13 lbs.

**Art. 1777/4**  
(ex 9146/3)  
Mtl 1" sq.  
H 47"  
Wt. 13 lbs.

**Art. 1777/1**  
(ex 9146/4)  
Mtl 1" sq.  
H 47"  
Wt. 13 lbs.



**Art. 801/4**  
Mtl 1 3/16" dia.  
H 43"  
Wt. 11 lbs.



**Art. 1149/7**  
Mtl 3/4" sq.  
H 47"  
Wt. 8.1 lbs.



**Art. 1149/8**  
Mtl 3/4" sq.  
H 47"  
Wt. 8.1 lbs.



**Art. 1203/1**  
Mtl 15/16" dia.  
H 47"  
Wt. 7.7 lbs.



**Art. 1203/2**  
Mtl 15/16" dia.  
H 47"  
Wt. 7.7 lbs.



**Art. 145/3**  
Mtl 1 9/16" dia.  
H 39 3/8"  
Wt. 5.5 lbs.

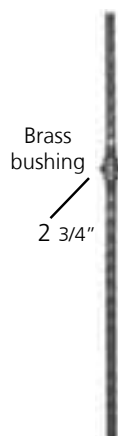

**Art. 111/3**  
Mtl 1 3/16" sq.  
H 47"  
Wt. 15.8 lbs.



**Art. 806/6**  
Tube Mtl 1 9/16" dia.  
H 47"  
Wt. 4.5 lbs.



**Art. 807/1**  
Mtl 1 3/16" dia.  
H 47"  
Wt. 16 lbs.

Shown:798/2



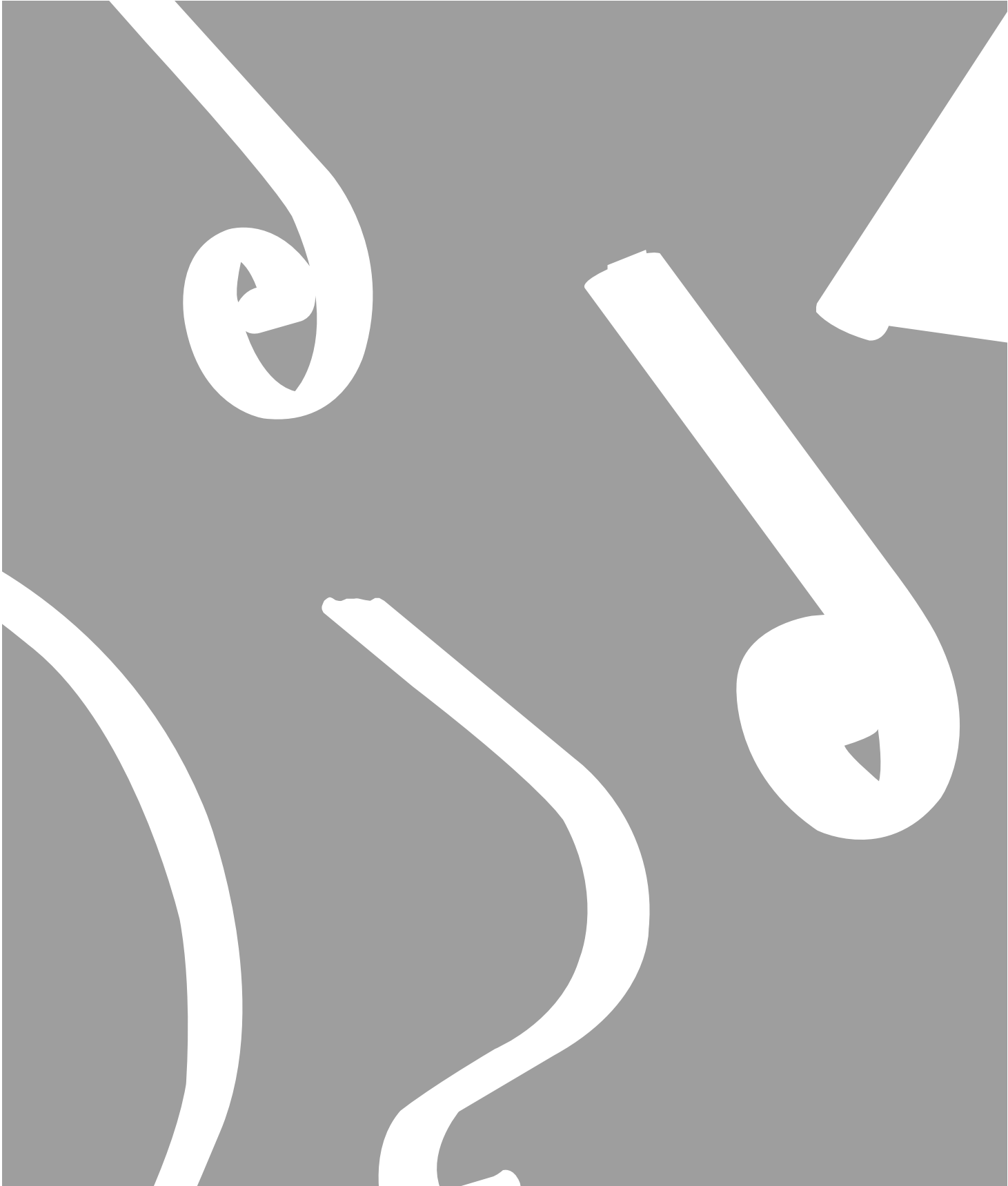

# HANDRAIL AND LONG BARS

Quick Reference # 7 2011

810/B/13  
1377/38  
1817/12  
114/B/1



**Art. 626/1**  
Mtl 1 9/16" dia.  
1/8" Thick  
L 10' approx  
Wt. 17 lbs.



**Art. 1375/1**  
Mtl 5/8" dia.  
1/16" Thick  
L 10' approx



Shown: Grooved Round Tube

ARTEFERRO

Shown: Grooved Round Tube



ARTEFERRO



**Art. 1794/9**  
Mtl 1 9/16" dia.  
3/32" Thick  
L 10' approx  
Wt. 7.5 lbs.



**MCRMTH**  
Tubular Handrail:  
Width 1 3/4"  
Channel 1"  
Length 20' feet  
Thickness 14 gauge

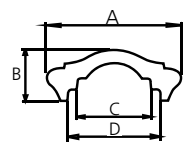
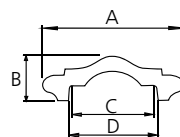
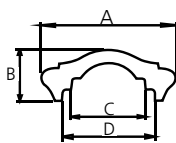
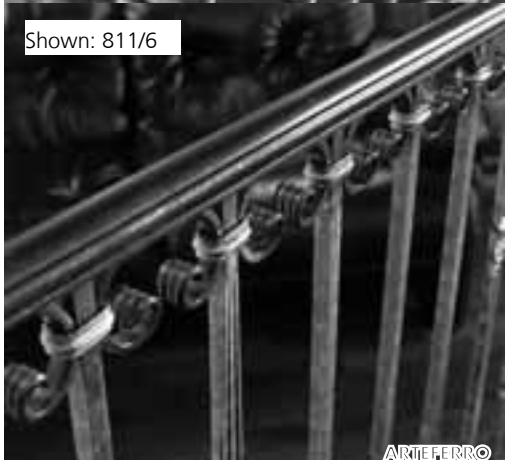
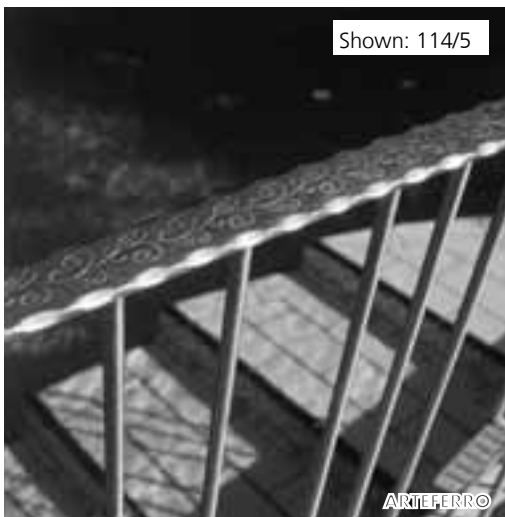
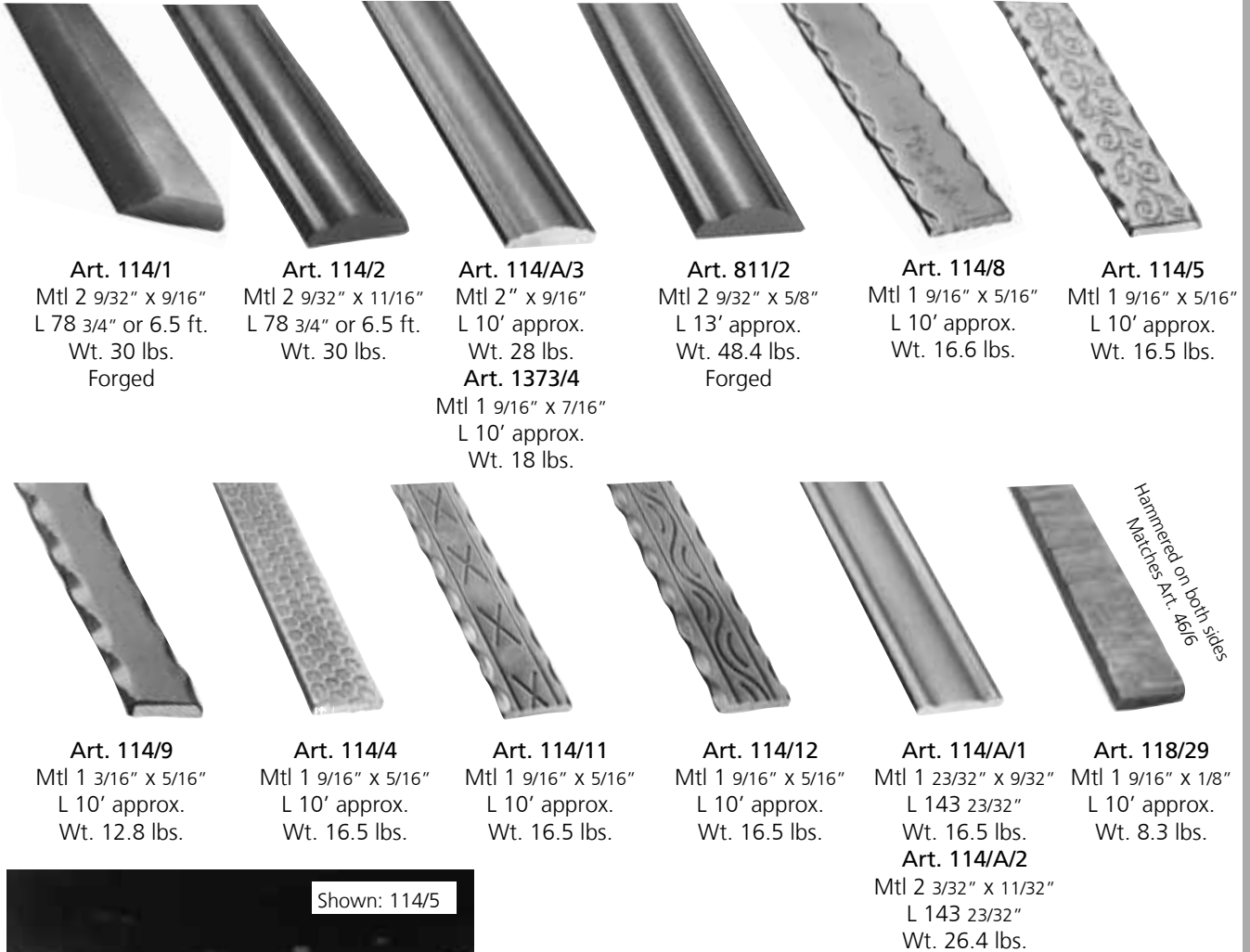

Choosing a handrail is as important as the balusters!  
Our 114/1 and 114/2 give a forged look. The 114/1 is somewhat less formal in design. Any of these rails work beautifully with our balusters and scrolls.

Handrails

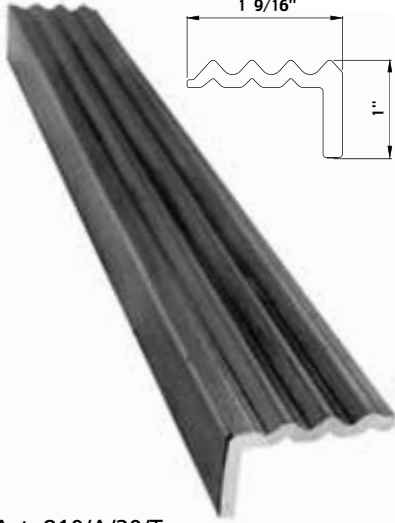
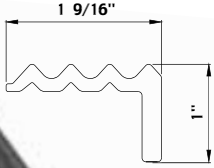
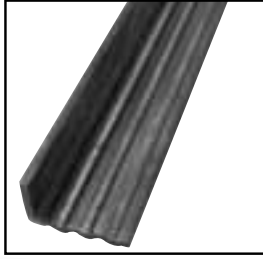

Art. 810/A/20/T  
L ≈ 19' 8" approx.  
Wt. 25.5 lbs.



Sizes in inches are approximate  
Weights in pounds and kilograms are approximate

\* TO FIT 3/4" TUBING, CHANNEL OR FLAT

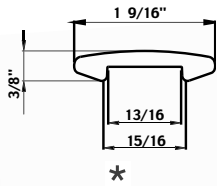

Art. 810/B/16/T  
L ≈ 19' 8" approx.  
Wt. 25.08 lbs.

\* TO FIT 3/4" TUBING, CHANNEL OR FLAT

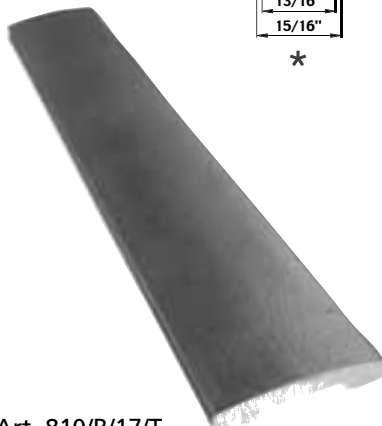
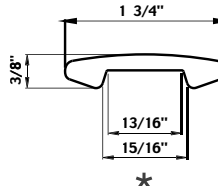

Art. 810/B/17/T  
L ≈ 19' 8" approx.  
Wt. 37.8 lbs.

\* TO FIT 1" TUBING, CHANNEL OR FLAT

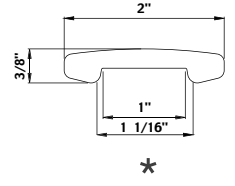

Art. 810/B/18/T  
L ≈ 19' 8" approx.  
Wt. 41.8 lbs.

# Handrails



Shown: 810/B/5/T

\* To fit 9/16" SQUARE BAR

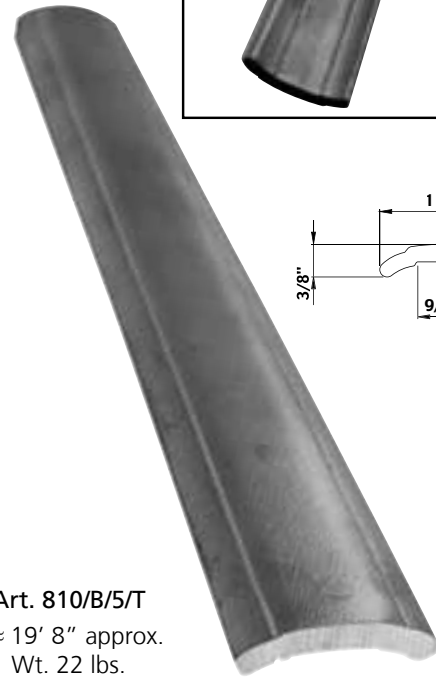
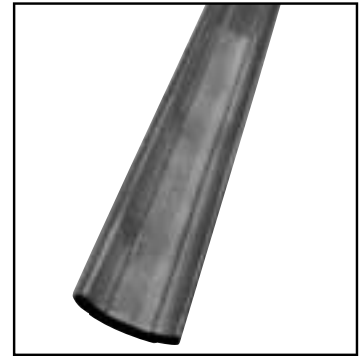

Art. 810/B/5/T  
L ≈ 19' 8" approx.  
Wt. 22 lbs.

Sizes in inches are approximate - Weights in pounds and kilograms are approximate

\* To fit 3/4" TUBING CHANNEL OR FLAT



\* To fit 3/4" TUBING CHANNEL OR FLAT

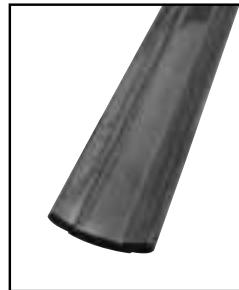

\* To fit 1" TUBING CHANNEL OR FLAT

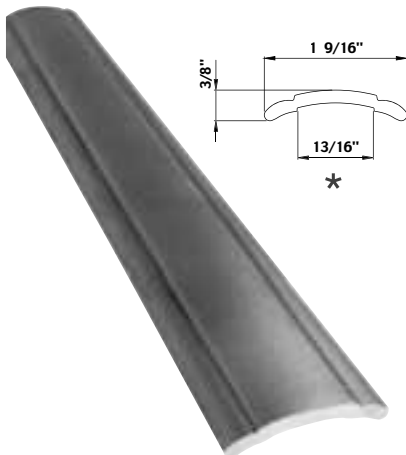

Art. 810/B/6/T  
L ≈ 19' 8" approx.  
Wt. 21 lbs.

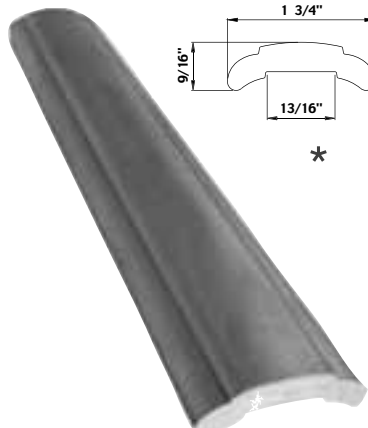

Art. 810/B/7/T  
L ≈ 19' 8" approx.  
Wt. 37.8 lbs.

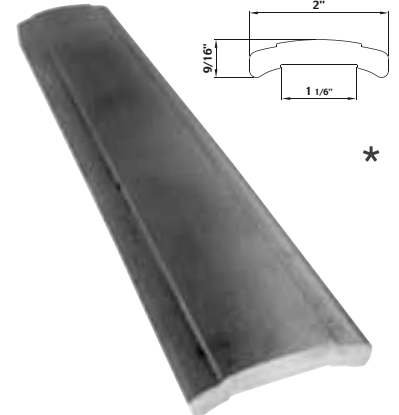

Art. 810/B/8/T  
L ≈ 19' 8" approx.  
Wt. 52 lbs.



# Handrails

\* To fit 1" TUBING CHANNEL OR FLAT

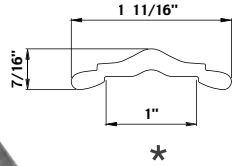
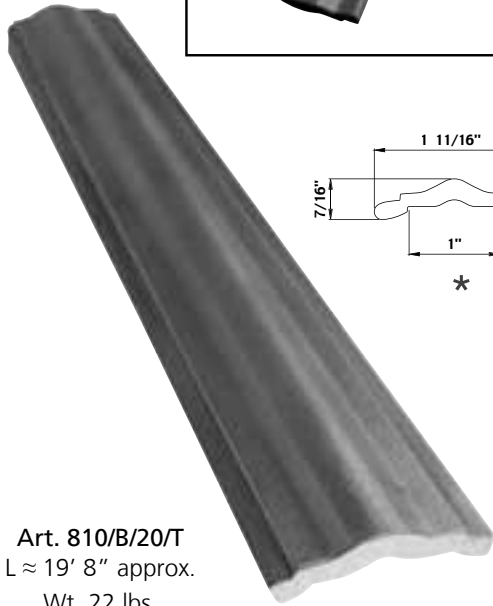
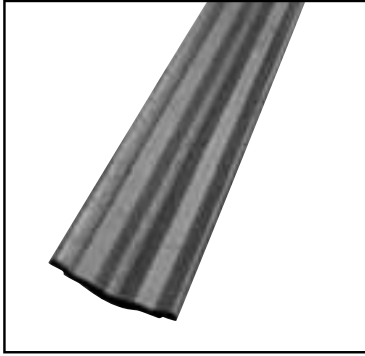

Art. 810/B/20/T  
L ≈ 19' 8" approx.  
Wt. 22 lbs.

Shown: 810/B/20/T



Sizes in inches are approximate - Weights in pounds and kilograms are approximate

\* To fit 1 1/4" TUBING CHANNEL OR FLAT

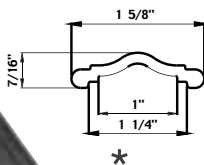
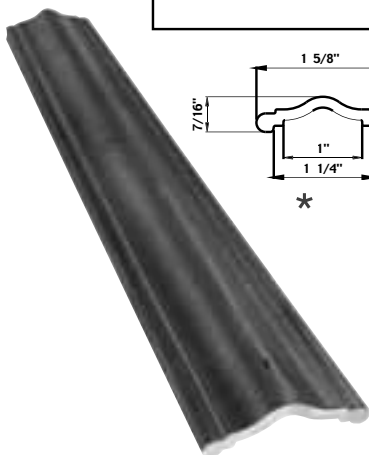

Art. 811/7/T  
L ≈ 19' 8" approx.  
Wt. 20.7 lbs.

\* To fit 1 1/4" TUBING CHANNEL OR FLAT

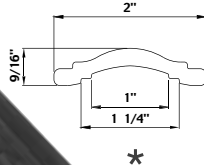

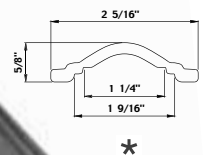
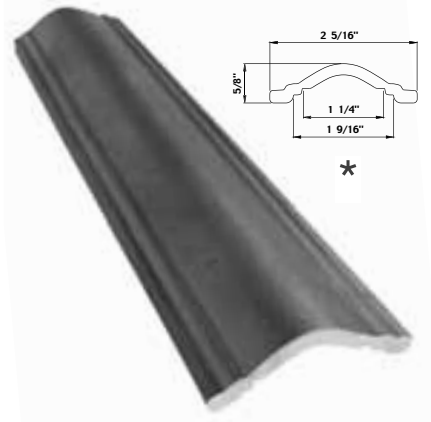

Art. 811/8/T  
L ≈ 19' 8" approx.  
Wt. 31.24 lbs.

\* To fit 1 1/4" AND 1 9/16" TUBING CHANNEL OR FLAT



Art. 811/6/T  
L ≈ 19' 8" approx.  
Wt. 36.1 lbs.

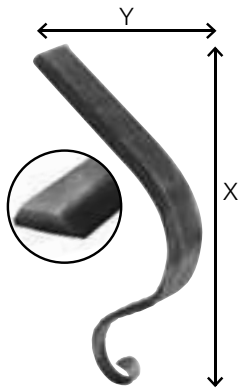

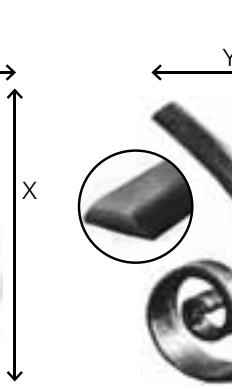
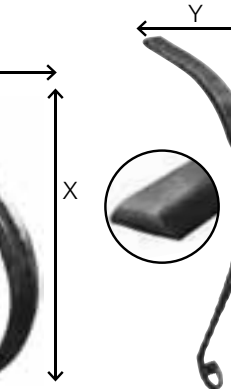
# End Pieces for Handrails

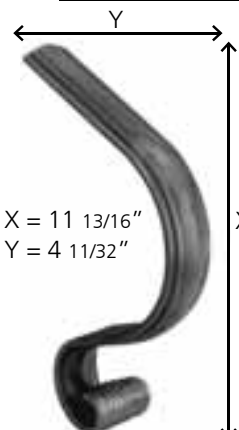
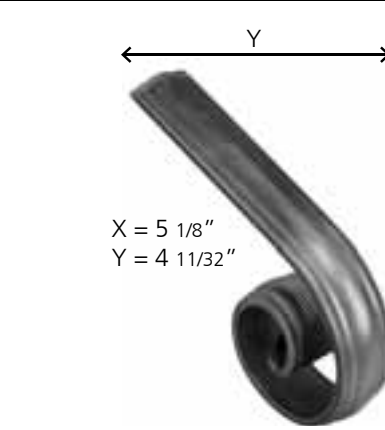
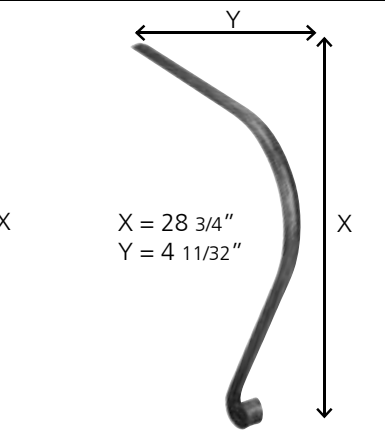
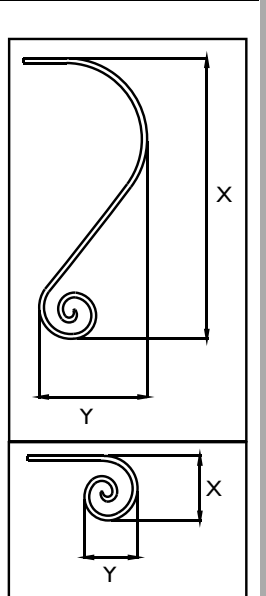
				
<b>Art. 115/1</b> for handrail Art. 114/1 Wt. 6.13 lbs. X = 10 3/4" Y = 16 3/16"	<b>Art. 115/2</b> for handrail Art. 114/2 Wt. 4.5 lbs. X = 10 3/4" Y = 16 3/16"	<b>Art. 115/3</b> for handrail Art. 114/2 Wt. 6.14 lbs. X = 7 5/16" Y = 12 3/16"	<b>Art. 115/4</b> for handrail Art. 114/1 Wt. 6.2 lbs. X = 7 5/16" Y = 12 3/16"	<b>Art. 115/5</b> for handrail Art. 114/1 Wt. 12.11 lbs. X = 30" Y = 27 3/8"

			
X = 11 13/16" Y = 4 11/32"	X = 5 1/8" Y = 4 11/32"	X = 28 3/4" Y = 4 11/32"	
<b>Art. 114/B/14</b> for handrail Art. 114/A/3 Wt. 5.8 lbs.	<b>Art. 114/B/13</b> for handrail Art. 114/A/3 Wt. 5.8 lbs.	<b>Art. 114/B/15</b> for handrail Art. 114/A/3 Wt. 14.5 lbs.	
<b>Art. 1377/12</b> for handrail Art. 1373/4 Wt. 3.5 lbs.	<b>Art. 1377/25</b> for handrail Art. 1373/4 Wt. 3.9 lbs.	<b>Art. 1377/38</b> for handrail Art. 1373/4 Wt. 8.6 lbs.	
<b>Art. 1817/7</b> (ex 9154/1) for handrail Art. 811/2 Wt. 6.9 lbs.	<b>Art. 812/14</b> for handrail Art. 811/2 Wt. 6.9 lbs.	<b>Art. 1817/4</b> (ex 9154/2) for handrail Art. 811/2 Wt. 17.2 lbs.	

MEASUREMENTS ARE SUBJECT TO CHANGE

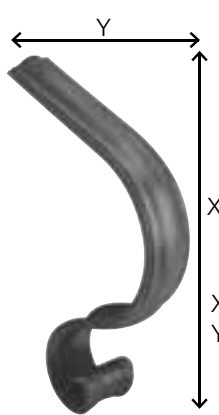

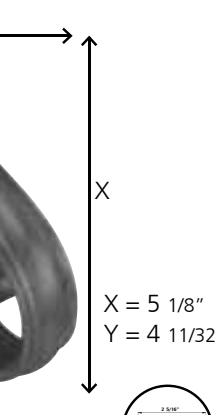
		
X = 11 13/16" Y = 4 11/32"	X = 5 1/8" Y = 4 11/32"	X = 28 3/4" Y = 4 11/32"
<b>Art. 1377/40</b> for handrail Art. 811/6 Wt. 4.13 lbs.	<b>Art. 812/12</b> for handrail Art. 811/6 Wt. 3.9 lbs.	<b>Art. 1819/10</b> (ex 9154/3) for handrail Art. 811/6 Wt. 9.5 lbs.
<b>Art. 1377/41</b> for handrail Art. 811/7 Wt. 2.8 lbs.	<b>Art. 812/13</b> for handrail Art. 811/7 Wt. 2.9 lbs.	<b>Art. 1819/11</b> (ex 9154/4) for handrail Art. 811/7 Wt. 7.5 lbs.

# End Pieces for Handrail

MEASUREMENTS ARE SUBJECT TO CHANGE

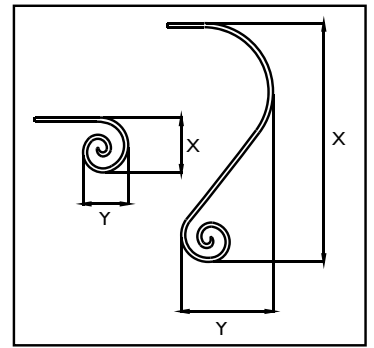
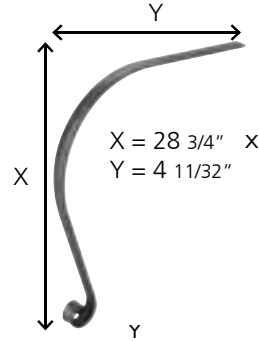
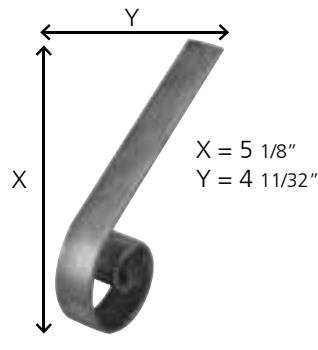
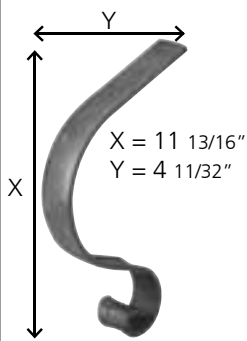

Art. 1377/1/T Wt. 2 lbs. for handrail Art. 810/B/5/T



Art. 1377/14/T Wt. 2 lbs. for handrail Art. 810/B/5/T



Art. 1820/1 (ex 9155/1) Wt. 2 lbs. for handrail Art. 810/B/5/T



Art. 1377/2/T Wt. 2 lbs. for handrail Art. 810/B/6/T



Art. 1377/15/T Wt. 2 lbs. for handrail Art. 810/B/6/T



Art. 1820/2 (ex 9155/2) Wt. 4.9 lbs. for handrail Art. 810/B/6/T



Art. 1377/3/T Wt. 3.5 lbs. for handrail Art. 810/B/7/T



Art. 1377/16/T Wt. 3.5 lbs. for handrail Art. 810/B/7/T



Art. 1820/3 (ex 9155/3) Wt. 8.8 lbs. for handrail Art. 810/B/7/T



Art. 1377/4/T Wt. 4 lbs. for handrail Art. 810/B/8/T



Art. 1377/17/T Wt. 4 lbs. for handrail Art. 810/B/8/T



Art. 1820/4 (ex 9155/4) Wt. 9.9 lbs. for handrail Art. 810/B/8/T



Art. 1377/7/T Wt. 2 lbs. for handrail Art. 810/B/16/T



Art. 1377/20/T Wt. 2 lbs. for handrail Art. 810/B/16/T



Art. 1820/5 (ex 9155/5) Wt. 4.9 lbs. for handrail Art. 810/B/16/T



Art. 1377/8/T Wt. 2.9 lbs. for handrail Art. 810/B/17/T



Art. 1377/21/T Wt. 2.9 lbs. for handrail Art. 810/B/17/T



Art. 1820/6 (ex 9155/6) Wt. 7.1 lbs. for handrail Art. 810/B/17/T



Art. 1377/9/T Wt. 3.7 lbs. for handrail Art. 810/B/18/T



Art. 1377/22/T Wt. 3.7 lbs. for handrail Art. 810/B/18/T



Art. 1820/7 (ex 9155/7) Wt. 9.3 lbs. for handrail Art. 810/B/18/T



Art. 1377/5/T Wt. 2.3 lbs. for handrail Art. 810/B/20/T



Art. 1377/18/T Wt. 2.3 lbs. for handrail Art. 810/B/20/T



Art. 1820/8 (ex 9155/8) Wt. 5.8 lbs. for handrail Art. 810/B/20/T



Art. 1377/40/T Wt. 3.2 lbs. for handrail Art. 811/6/T



Art. 812/12/T Wt. 3.2 lbs. for handrail Art. 811/6/T



Art. 1820/9 (ex 9155/9) Wt. 8.1 lbs. for handrail Art. 811/6/T



Art. 1377/41/T Wt. 1.7 lbs. for handrail Art. 811/7/T



Art. 812/13/T Wt. 1.7 lbs. for handrail Art. 811/7/T



Art. 1820/10 (ex 9155/10) Wt. 4.2 lbs. for handrail Art. 811/7/T



Art. 1377/42/T Wt. 2.7 lbs. for handrail Art. 811/8/T



Art. 812/15/T Wt. 2.7 lbs. for handrail Art. 811/8/T



Art. 1820/11 (ex 9155/11) Wt. 6.8 lbs. for handrail Art. 811/8/T

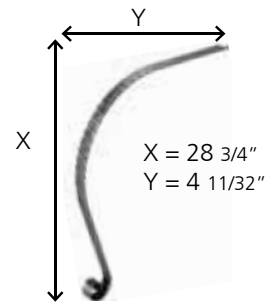
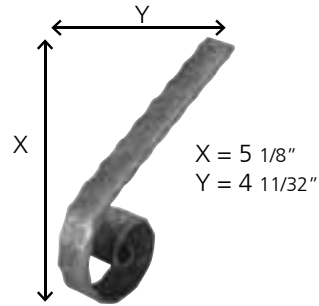
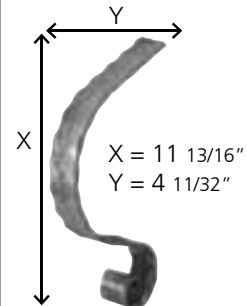

Art. 116/2 Wt. 3 lbs. for handrail Art. 114/5



Art. 116/10 Wt. 3 lbs. for handrail Art. 114/5



Art. 114/B/5 Wt. 7.5 lbs. for handrail Art. 114/5



Art. 116/5 Wt. 3 lbs. for handrail Art. 114/8



Art. 116/5 Wt. 3 lbs. for handrail Art. 114/8



Art. 114/B/8 Wt. 7.5 lbs. for handrail Art. 114/8



Art. 116/1 Wt. 3 lbs. for handrail Art. 114/4



Art. 116/9 Wt. 3 lbs. for handrail Art. 114/4



Art. 114/B/4 Wt. 7.5 lbs. for handrail Art. 114/4



Art. 116/7 Wt. 3 lbs. for handrail Art. 114/11



Art. 116/15 Wt. 3 lbs. for handrail Art. 114/11



Art. 114/B/10 Wt. 7.5 lbs. for handrail Art. 114/11



Art. 116/8 Wt. 3 lbs. for handrail Art. 114/12



Art. 116/16 Wt. 3 lbs. for handrail Art. 114/12



Art. 114/B/11 Wt. 7.5 lbs. for handrail Art. 114/12



Art. 114/B/1 Wt. 3.2 lbs. for handrail Art. 114/A/1



Art. 1818/15 (ex 9155/12) Wt. 3.2 lbs. for handrail Art. 114/A/1



Art. 1818/5 (ex 9155/14) Wt. 8 lbs. for handrail Art. 114/A/1



Art. 114/B/2 Wt. 5.2 lbs. for handrail Art. 114/A/2



Art. 1818/16 (ex 9155/13) Wt. 5.2 lbs. for handrail Art. 114/A/2













Art. 1818/6 (ex 9155/15) Wt. 13 lbs. for handrail Art. 114/A/2









Mtl. 8 1/6" dia.



- Art. 1825/9 (ex 9156/1)  
for handrail Art. 810/B/5/T  
Wt. 1.1 lbs. 
- Art. 1825/10 (ex 9156/2)  
for handrail Art. 810/B/6/T  
Wt. 1 lbs. 
- Art. 1825/11 (ex 9156/3)  
for handrail Art. 810/B/7/T  
Wt. 1.9 lbs. 
- Art. 1825/12 (ex 9156/4)  
for handrail Art. 810/B/8/T  
Wt. 2.6 lbs. 
- Art. 1825/13 (ex 9156/5)  
for handrail Art. 810/B/16/T  
Wt. 1.2 lbs. 
- Art. 1825/14 (ex 9156/6)  
for handrail Art. 810/B/17/T  
Wt. 1.9 lbs. 
- Art. 1825/15 (ex 9156/7)  
for handrail Art. 810/B/18/T  
Wt. 2.1 lbs. 
- Art. 1825/16 (ex 9156/8)  
for handrail Art. 811/6/T  
Wt. 1.9 lbs. 
- Art. 1825/17 (ex 9156/9)  
for handrail Art. 811/7/T  
Wt. 1 lbs. 
- Art. 1825/18 (ex 9156/10)  
for handrail Art. 811/8/T  
Wt. 1.5 lbs. 





Mtl. 12 25/32" dia.



- Art. 1822/1 (ex 9156/11)  
for handrail Art. 114/A/3  
Wt. 6.6 lbs. 
- Art. 1822/2 (ex 9156/12)  
for handrail Art. 1373/4  
Wt. 4.4 lbs. 
- Art. 1822/7 (ex 9156/13)  
for handrail Art. 114/A/1  
Wt. 3.3 lbs. 
- Art. 1822/8 (ex 9156/14)  
for handrail Art. 114/A/2  
Wt. 5.5 lbs. 
- Art. 1822/9 (ex 9156/15)  
for handrail Art. 114/1  
Wt. 11.3 lbs. 
- Art. 1822/10 (ex 9156/16)  
for handrail Art. 114/2  
Wt. 11.3 lbs. 
- Art. 1822/6 (ex 9156/17)  
for handrail Art. 811/2  
Wt. 8.2 lbs. 

Mtl. 12 25/32" dia.



- Art. 116/A/8  
for handrail Art. 114/4  
Wt. 3.8 lbs. 
- Art. 116/A/9  
for handrail Art. 114/5  
Wt. 3.8 lbs. 
- Art. 116/A/12  
for handrail Art. 114/8  
Wt. 3.8 lbs. 
- Art. 116/A/14  
for handrail Art. 114/11  
Wt. 3.8 lbs. 
- Art. 116/A/15  
for handrail Art. 114/12  
Wt. 3.8 lbs. 







Shown: 1822/12



ARTEFERRO





Mtl. 6 13/32" dia.

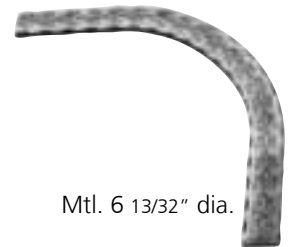

- Art. 1822/12 (ex 9156/18)  
for handrail Art. 114/A/3  
Wt. 6.6 lbs. 
- Art. 1822/13 (ex 9156/19)  
for handrail Art. 1373/4  
Wt. 4.4 lbs. 
- Art. 1822/18 (ex 9156/20)  
for handrail Art. 114/A/1  
Wt. 3.3 lbs. 
- Art. 1822/19 (ex 9156/21)  
for handrail Art. 114/A/2  
Wt. 5.5 lbs. 
- Art. 1822/17 (ex 9156/22)  
for handrail Art. 811/2  
Wt. 8.2 lbs. 
- Art. 1822/20 (ex 9156/23)  
for handrail Art. 114/1  
Wt. 11.3 lbs. 
- Art. 1822/21 (ex 9156/24)  
for handrail Art. 811/2  
Wt. 11.3 lbs. 

Mtl. 6 13/32" dia.



- Art. 116/25  
for handrail Art. 114/4  
Wt. 3.7 lbs. 
- Art. 116/26  
for handrail Art. 114/5  
Wt. 3.7 lbs. 
- Art. 116/29  
for handrail Art. 114/8  
Wt. 3.7 lbs. 
- Art. 116/31  
for handrail Art. 114/11  
Wt. 3.7 lbs. 
- Art. 116/32  
for handrail Art. 114/12  
Wt. 3.7 lbs. 

## Decorative Bars

length of bars  
L 10' Approx.

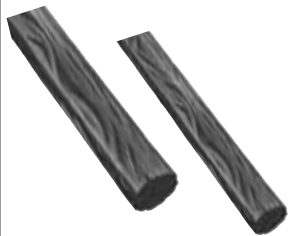

**Art. 599/1**  
Mtl 5/16" dia.  
Wt. 2.5 lbs.

**Art. 599/2**  
Mtl 3/8" dia.  
Wt. 4 lbs.

**Art. 599/3**  
Mtl 1/2" dia.  
Wt. 5.7 lbs.

**Art. 599/4**  
Mtl 9/16" dia.  
Wt. 8 lbs.

**Art. 599/5**  
Mtl 5/8" dia.  
Wt. 10.3 lbs.

**Art. 599/6**  
Mtl 23/32" dia.  
Wt. 13 lbs.

**Art. 599/7**  
Mtl 13/16" dia.  
Wt. 16 lbs.

**Art. 599/8**  
Mtl 7/8" dia.  
Wt. 19.3 lbs.

length of bars L 10' Approx.  
Available in 20' Approximate length  
MECHANICALLY HAMMERED ROUND BAR

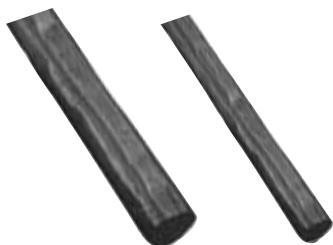

**Art. 600/1**  
(ex 12/14 TB)  
Mtl 1/4" dia.  
Wt. 1.5 lbs.

**Art. 600/2**  
(ex 12/516 TB)  
Mtl 5/16" dia.  
Wt. 2.5 lbs.

**Art. 600/3**  
(ex 12/38 TB)  
Mtl 3/8" dia.  
Wt. 4 lbs.

**Art. 600/4**  
(ex 12/12 TB)  
Mtl 1/2" dia.  
Wt. 5.7 lbs.

**Art. 600/6**  
Mtl 5/8" dia.  
Wt. 10.3 lbs.

**Art. 600/7**  
(ex 12/34 TB)  
Mtl 23/32" dia.  
Wt. 12.72 lbs.

**Art. 600/9**  
(ex 12/78 TB)  
Mtl 7/8" dia.  
Wt. 18.9 lbs.

OFFERING SPECIAL PRODUCTION  
LARGER DIAMETERS  
CHECK WITH SALES

length of bars L 10' Approx.  
Available in 20' Approximate length  
MECHANICALLY HAMMERED ROUND BAR  
(vineyard effect)

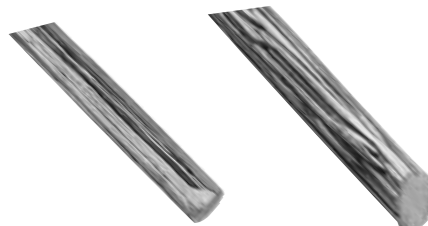

**Art. 598/9**  
Mtl 5/16" dia.  
Wt. 2.5 lbs.

**Art. 598/11**  
Mtl 5/16" dia.  
Wt. 2.9 lbs.

**Art. 598/13**  
Mtl 1/2" dia.  
Wt. 5.7 lbs.

**Art. 598/16**  
Mtl 23/32" dia.  
Wt. 12.8 lbs.

length of bars  
L 10' Approx.



**Art. 623/5**  
Mtl 1/2" sq.  
Wt. 7.5 lbs.

**Art. 623/6**  
Mtl 9/16" sq.  
Wt. 8.6 lbs.

**Art. 623/7**  
Mtl 5/8" sq.  
Wt. 13.3 lbs.

**Art. 623/8**  
Mtl 11/16" sq.  
Wt. 16.8 lbs.

**Art. 623/9**  
Mtl 3/4" sq.  
Wt. 19 lbs.

Shown: 599/1



OFFERING SPECIAL PRODUCTION  
LARGER DIAMETERS  
CHECK WITH SALES

Decorative Bars

length of bars L 10' Approx.  
Available in 20'  
Approximate length



**Art. 1370/13**  
Mtl 1/2" sq.  
Wt. 7.5 lbs.  
2 sides diamond  
hammered profile

These are a good match for all  
of the forged round pickets

Grooved long bars length of  
bar L 10' Approx.



**Art. 625/3**  
Mtl 1/2" sq.  
Wt. 7 lbs.  
**Art. 625/5**  
Mtl 5/8" sq.  
Wt. 12.8 lbs.  
**Art. 625/7**  
Mtl 13/16" sq.  
Wt. 20.2 lbs.

Grooved & Hammered long bars length  
of bar L 10' Approx.  
Available in 20' Approximate length

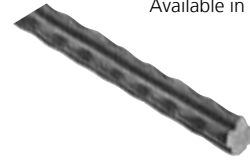

**Art. 625/8**  
Mtl 1/2" sq.  
Wt. 6.6 lbs.  
**Art. 625/9**  
Mtl 5/8" sq.  
Wt. 12.8 lbs.  
**Art. 625/10**  
Mtl 3/4" sq.  
Wt. 20.9 lbs.



Shown: 118/2

Heavily hammered bars  
mechanically hammered on 4 corners and  
4 sides length of bars 10' Approx.  
Available in 20' Approximate length



Good match for all the  
forged square pickets

**Art. 118/A1**  
Mtl 1/2" sq.  
Wt. 5.7 lbs.  
**Art. 118/A2**  
Mtl 9/16" sq.  
Wt. 10.2 lbs.  
**Art. 118/A3**  
Mtl 5/8" sq.  
Wt. 11 lbs.  
**Art. 118/A5**  
Mtl 13/16" sq.  
Wt. 20.7 lbs.

Cold forged square bars hammered  
on four corners length of bars 20' Approx.



**Art. 118/1**  
Mtl 1/2" sq.  
Wt. 13.9 lbs.  
**Art. 118/2**  
Mtl 9/16" sq.  
Wt. 19.8 lbs.  
**Art. 118/3**  
Mtl 5/8" sq.  
Wt. 24.6 lbs.  
**Art. 118/5**  
Mtl 13/16" sq.  
Wt. 37.8 lbs.  
**Art. 118/6**  
Mtl 1" sq.  
Wt. 64.8 lbs.

# Bars & Tubes



Four sides hammered tubes  
L 20' Approx.

\* Cut lengths for UPS shipments available

\* AVAILABLE IN 24' LENGTH  
Offering heavy wall options for 1" sq. and larger

Art. 118/E/1*	Mtl 3/4" sq.	Wt. 16.5 lbs.
Art. 118/E/2	Mtl 1 3/16" x 3/4"	Wt. 21.6 lbs.
Art. 118/E/3*	Mtl 1 3/16" sq.	Wt. 26.8 lbs.
Art. 118/E/4	Mtl 1 9/16" x 3/4"	Wt. 26.8 lbs.
Art. 118/E/5	Mtl 1 1/2" sq.	Wt. 37.2 lbs.
Art. 1374/15*	Mtl 2" sq.	Wt. 48.4 lbs.
Art. 118/E/6*	Mtl 2" x 1"	Wt. 37.2 lbs.
Art. 118/E/7	Mtl 2 3/8" x 1 3/16"	Wt. 45.8 lbs.
Art. 118/E/8	Mtl 3" x 1 1/2"	Wt. 53 lbs.
Art. 118/E/9*	Mtl 1" sq.	Wt. 21.6 lbs.
Art. 118/E/10	Mtl 3 15/16" x 1 9/16"	Wt. 74.8 lbs.
Art. 1374/16	Mtl 3 sq.	Wt. 92.4 lbs.
Art. 1374/17	Mtl 4" sq.	Wt. 118.8 lbs.
Art. 1374/18	Mtl 4 3/4" sq.	Wt. 145.2 lbs.
Art. 1374/19*	Mtl 1/2" sq.	Wt. 4.3 lbs.
Art. 1374/20*	Mtl 5/8" sq.	Wt. 6.1 lbs.

## COLLAR (BANDING) MATERIAL

Length of bars 13' Approx.



Art. 158/1  
Mtl 9/16" x 5/32"  
Wt. 3.1 lbs.

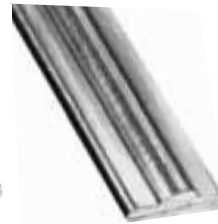

Art. 158/3  
Mtl 9/16" x 5/32"  
Wt. 2.6 lbs.



Art. 158/6  
Mtl 9/16" x 5/32"  
Wt. 2.6 lbs.



Art. 158/20  
2 bars of 5/16" sq.  
Art. 158/23  
2 bars of 3/8" x 3/16"



Art. 158/15  
3 bars of 1/2" x 1/4"  
Art. 158/16  
4 bars of 1/2" x 1/4"

Art. 158/26  
2 bars of 1/2" x 1/4"  
Art. 158/27  
3 bars of 1/2" x 1/4"  
Art. 158/30  
2 bars of 1/2" sq.



ARTIFERRO®

Standard bar length L 10' Approx.

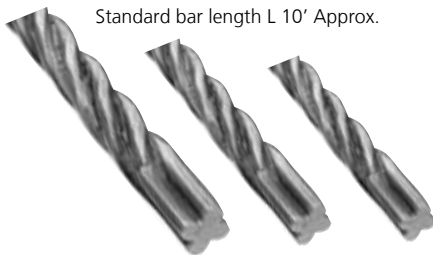

Art. 626/3	Art. 626/7
Mtl 1/2" dia.	Mtl 25/32" dia.
Wt. 8 lbs.	Wt. 22.2 lbs.
Art. 626/4	Art. 626/8
Mtl 9/16" dia.	Mtl 13/16" dia.
Wt. 5.7 lbs.	Wt. 27 lbs.
Art. 626/5	Art. 626/17
Mtl 5/8" dia.	Mtl 15/16" dia.
Wt. 8.4 lbs.	Wt. 32 lbs.
Art. 626/6	Art. 626/9
Mtl 3/4" dia.	Mtl 1" dia.
Wt. 18 lbs.	Wt. 37.5 lbs.

## OFFERING SPECIAL PRODUCTION LARGER DIAMETERS CHECK WITH SALES

L 106 1/4" Approx.



### TWISTED ROUND BAR ROPE

Art. 119/1
Mtl 5/8" dia.
Wt. 6.4 lbs.
Art. 119/2
Mtl 3/4" dia.
Wt. 10.6 lbs.
Art. 119/3
Mtl 1 3/16" dia.
Wt. 23.3 lbs.

length of bars L 10' Approx.  
Available in 20'  
Approximate length



Art. 626/11	Art. 626/15
Mtl 9/16" dia.	Mtl 7/8" dia.
Wt. 5.3 lbs.	Wt. 14.5 lbs.
Art. 626/12	Art. 626/16
Mtl 5/8" dia.	Mtl 1 1/32" dia.
Wt. 7.1 lbs.	Wt. 21.6 lbs.
Art. 626/13	Art. 626/19
Mtl 11/16" dia.	Mtl 15/16" dia.
Wt. 9 lbs.	Wt. 16.8 lbs.
Art. 626/14	
Mtl 13/16" dia.	
Wt. 11.7 lbs.	



# Decorative and Twisted Heavy Bars



Shown: 614/4



B - C  
match for  
Art. 118/2

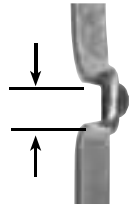

Mtl 1/2" sq.  
or Mtl 9/16" sq.

Art. 614/4  
A Mtl 9/16" sq.  
Wt. 6.6 lbs.

Art. 614/5  
B Mtl 9/16" sq.  
Wt. 6.6 lbs.

Art. 614/6  
C Mtl 9/16" sq.  
Wt. 6.6 lbs.

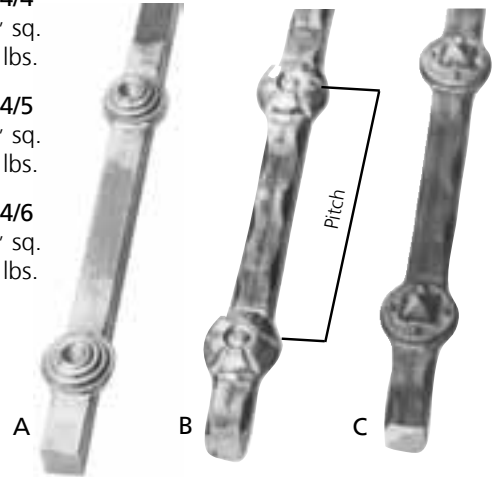

BARS 78 3/4" Approx. PITCH 4 15/16"

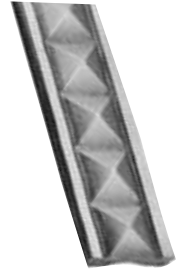

Art. 1837/6  
(ex 9160/1)  
Mtl 1 3/16" x 1/4"  
L 118 1/8"  
Wt. 6.6 lbs.

Art. 1834/1  
(ex 9160/2)  
Mtl 1 1/4" x 3/16"  
L 118 1/8"  
Wt. 7.5 lbs.

Art. 1834/2  
(ex 9160/3)  
Mtl 1 7/32" x 3/16"  
L 118 1/8"  
Wt. 7.5 lbs.

Art. 1834/3  
(ex 9160/4)  
Mtl 1 7/32" x 3/16"  
L 118 1/8"  
Wt. 7.5 lbs.

Art. 1834/4  
(ex 9160/5)  
Mtl 1 7/32" x 3/16"  
L 118 1/8"  
Wt. 6.9 lbs.

Art. 1834/5  
(ex 9160/6)  
Mtl 1 1/4" x 3/8"  
L 118 1/8"  
Wt. 7 lbs.



Art. 1806/13  
(ex 8052/13)  
Mtl 2" sq.  
L 118 1/8"  
Wt. 132 lbs.



Art. 1806/27  
(ex 8052/27)  
Mtl 2 3/8" x 1 3/16"  
L 118 1/8"  
Wt. 93.7 lbs.



Art. 1807/1  
(ex 8053/1)  
Mtl 2" sq.  
L 118 1/8"  
Wt. 132 lbs.



Art. 1807/13  
(ex 8053/13)  
Mtl 2" sq.  
L 118 1/8"  
Wt. 132 lbs.



HANDRAIL AND LONG BARS

ARTEFERRO

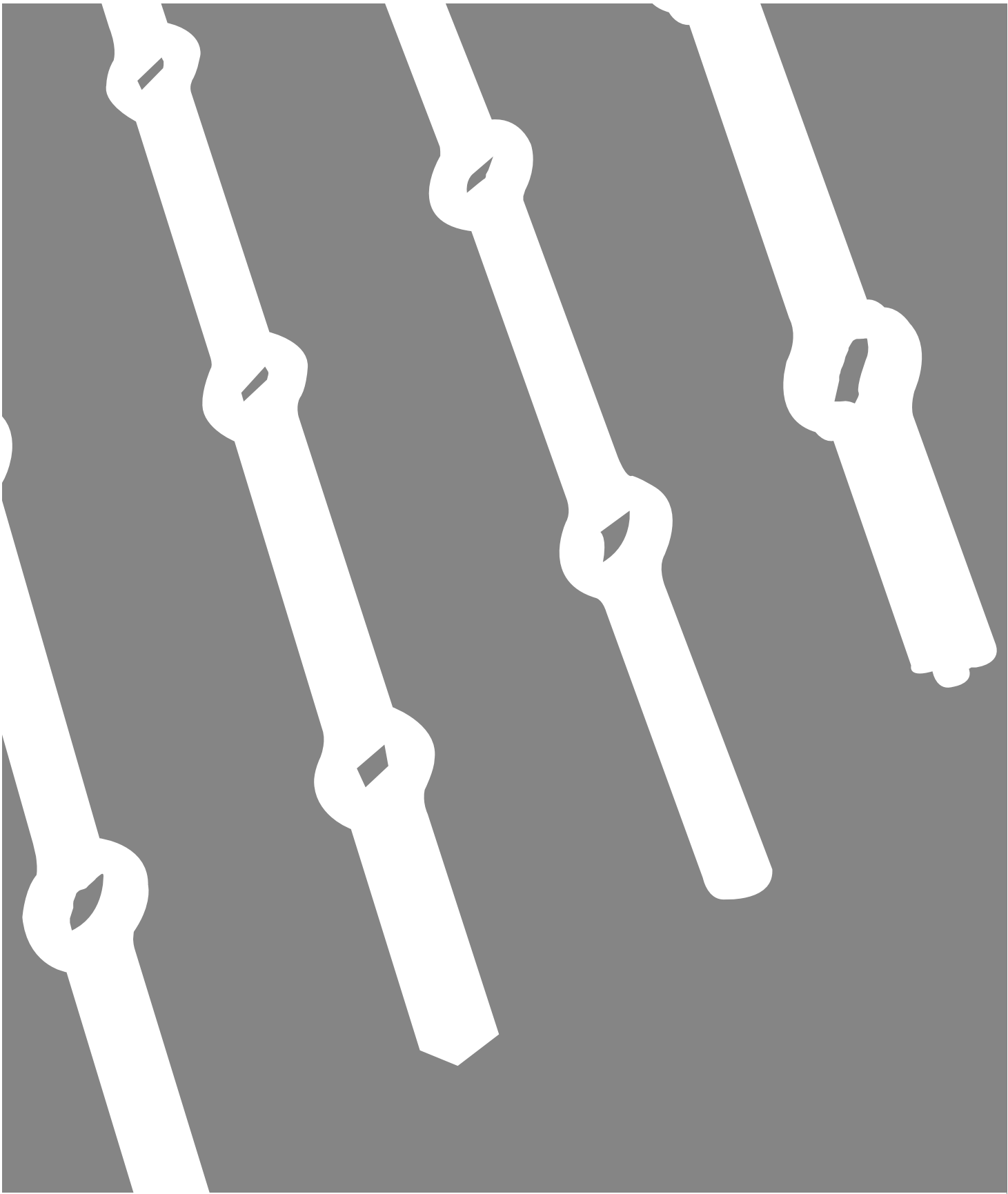

# PIERCED BARS

Quick Reference # 7 2011

Art. 1361/5  
Art. 1360/6  
Art. 42/8  
Art. 42/1

# New Items

## Square Punched Flat Bar

Item #	Bar Size	Hole Size	Holes #
Art. 1853/1	1 3/16" x 5/16"	1/2" sq.	16
Art. 608/6	1 3/16" x 5/16"	9/16" sq.	16

## Diamond Punched Flat Bar

Item #	Bar Size	Hole Size	Holes #
Art. 1853/51	1 3/16" x 5/16"	1/2" sq.	16
Art. 1853/54	1 3/16" x 5/16"	9/16" sq.	16

## Round Punched Flat Bar

Item #	Bar Size	Hole Size	Holes #
Art. 1853/105	1 3/16" x 5/16"	1/2" sq.	16
Art. 1853/108	1 3/16" x 5/16"	9/16" sq.	16

## Round Punched Flat Bar with Hammered Edges

Item #	Bar Size	Hole Size	Holes #
Art. 1853/177	1 3/16" x 5/16"	1/2" sq.	16
Art. 1853/180	1 3/16" x 5/16"	9/16" sq.	16

## Square Punched Flat Bar with Hammered Edges

Item #	Bar Size	Hole Size	Holes #
Art. 1853/159	1 3/16" x 5/16"	1/2" sq.	16
Art. 1853/162	1 3/16" x 5/16"	9/16" sq.	16

## Square Punched Flat Bar with Hammered Edges and Faces

Item #	Bar Size	Hole Size	Holes #
Art. 1853/195	1 3/16" x 5/16"	1/2" sq.	16
Art. 1853/198	1 3/16" x 5/16"	9/16" sq.	16

## Punched Flat Bar

L 78 3/4"

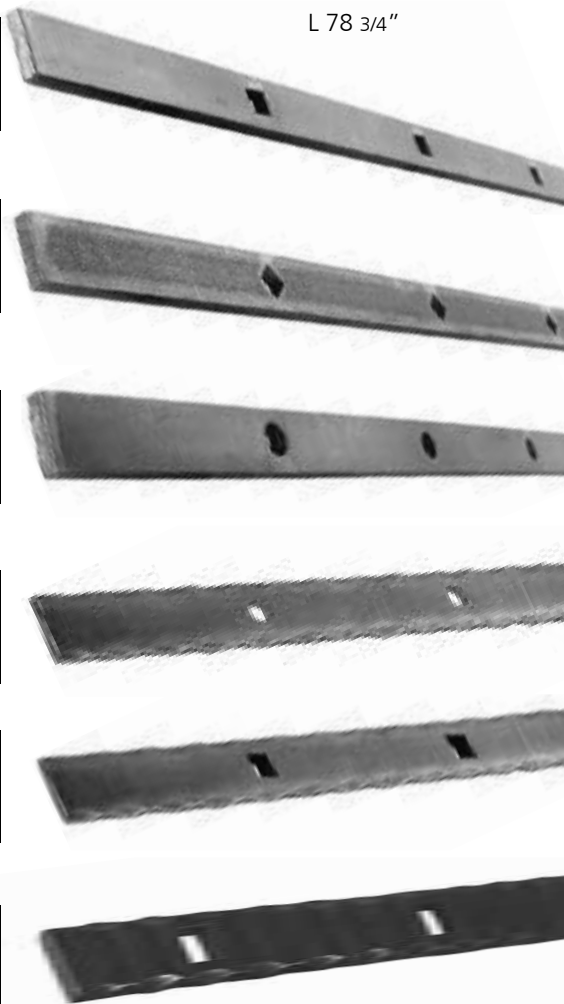

Shown: 1853/195, 118/1, 727/9



## Punched Channel

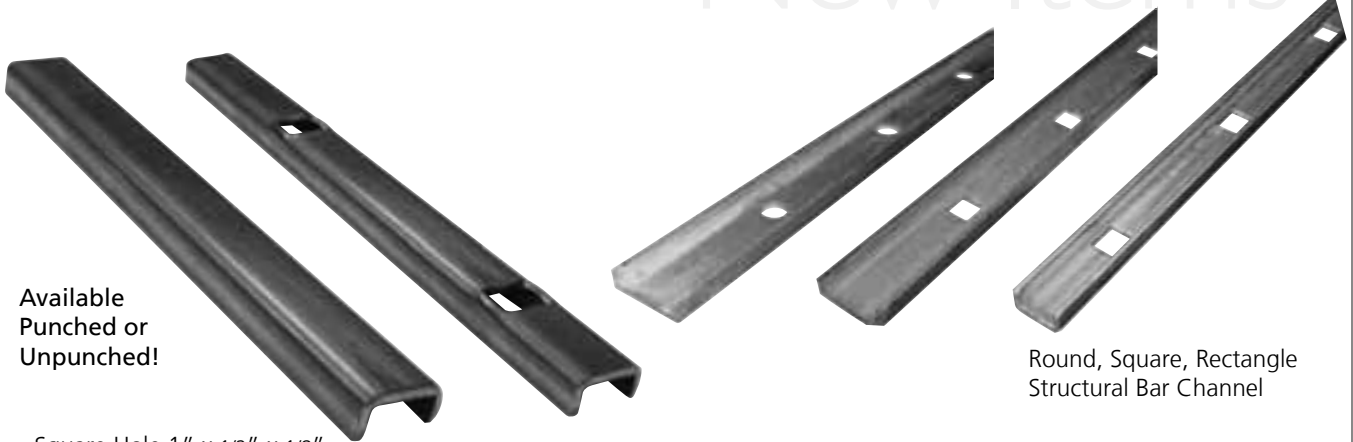

Available  
Punched or  
Unpunched!

Round, Square, Rectangle  
Structural Bar Channel

Square Hole 1" x 1/2" x 1/8"  
Rollformed Channel

Art.no.	Channel Size	HOLE SIZE	FITS PICKET	OPEN AREA	ON CENTER
H1004PBC	1" x 1/2" x 1/8"	9/16"	1/2" Square	3-1/2"	4"
H100412PBC	1" x 1/2" x 1/8"	9/16"	1/2" Square	4"	4-1/2"
H1005PBC	1" x 1/2" x 1/8"	9/16"	1/2" Square	4-1/2"	5"
H1006PBC	1" x 1/2" x 1/8"	9/16"	1/2" Square	5-1/2"	6"



Square Hole 1 1/2" x 1/2" x 1/8"  
Rollformed Channel

Art.no.	Channel Size	HOLE SIZE	FITS PICKET	OPEN AREA	ON CENTER
H1120412PBC	1 1/2" x 1/2" x 1/8"	9/16"	1/2" Square	3-1/2"	4"
H1120512PBC	1 1/2" x 1/2" x 1/8"	9/16"	1/2" Square	4-1/2"	5"
H1120612PBC	1 1/2" x 1/2" x 1/8"	9/16"	1/2" Square	5-1/2"	6"



H1120434PBC	1 1/2" x 1/2" x 1/8"	13/16"	3/4" Square	3-1/4"	4"
H1120534PBC	1 1/2" x 1/2" x 1/8"	13/16"	3/4" Square	4-1/4"	5"
H1120634PBC	1 1/2" x 1/2" x 1/8"	13/16"	3/4" Square	5-1/4"	6"

Square Hole 2" x 1" x 1/8"  
Rollformed Channel

Art.no.	Channel Size	HOLE SIZE	FITS PICKET	OPEN AREA	ON CENTER
H2118434PBC	2" x 1" x 1/8"	13/16"	3/4" Square	3-1/4"	4"
H2118534PBC	2" x 1" x 1/8"	13/16"	3/4" Square	4-1/4"	5"
H2118634PBC	2" x 1" x 1/8"	13/16"	3/4" Square	5-1/4"	6"



Unpunched  
Rollformed Channel

- Used for flush top or bottom
- 20 foot length

ITEM #	Channel Size
PBCR1000	1" x 1/2" x 1/8"
PBCR1120000	1-1/2" x 1/2" x 1/8"
PBCR2000	2" x 1" x 1/8"

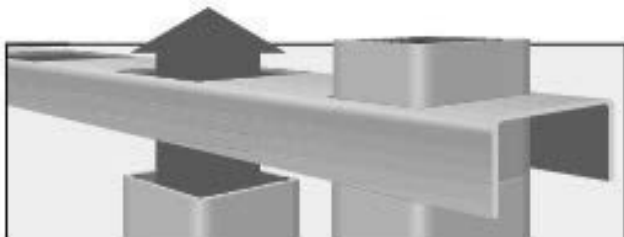

**Fabrication Ease:** Slide pickets through the punched holes and tack-weld. Attach to posts and your fence is built.

New Items **New Items**



**Art. 607/1**  
Mtl 9/16" dia.  
Pitch = 5 1/2"  
1 3/32" x 9/16" holes  
Distance 5"  
Holes number 14  
L 78 3/4"  
Wt. 5.2 lbs.

**Art. 607/2**  
Mtl 5/8" dia.  
Pitch = 5 7/8"  
1 1/4" x 5/8" holes  
Distance 5 9/32"  
Holes number 13  
L 78 3/4"  
Wt. 6.7 lbs.



Shown: 607/1

ARTEFERRO

Shown: 42/2/US



ARTEFERRO

Shown: 606/2, 599/5



ARTEFERRO



Pierced bar length 78 3/4" Approx. To be used with 599/4-5-6-7 line

Art.no.	Mtl. dia.	P = Pitch	Holes	Holes per bar	Weight
606/1	9/16"	5 1/2"	9/16"	14	5.2 lbs.
606/2	5/8"	5 7/8"	5/8"	13	7 lbs.
606/3	11/16"	6 5/16"	11/16"	12	9.3 lbs.
606/4	3/4"	6 5/8"	3/4"	11	11 lbs.

Meets U.S. 42 code

Art. 42/9 /US

Mtl 5/8" sq.  
D = 3 7/8"  
5/8" sq. holes  
17 holes  
Wt. 8.5 lbs.

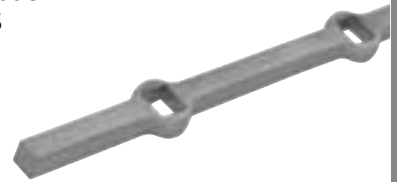

Art. 42/10

Mtl 11/16" sq.  
P = 6 5/16"  
23/32" sq. holes  
12 holes  
Wt. 11 lbs.



Art. 42/24

Mtl 23/32" sq.  
P = 6 5/16"  
23/32" sq. holes  
12 holes  
Wt. 11 lbs.



Pierced bar length 78 3/4" Approx. To be used with 626 series

Art.no.	Mtl. dia.	P = Pitch	Holes	Holes per bar	Weight
1361/1	1/2"	5 1/2"	1/2"	14	4.9 lbs.
1361/2	9/16"	5 7/8"	9/16"	13	7 lbs.
1361/3	19/32"	6 5/16"	19/32"	12	8.2 lbs.
1361/4	21/32"	5 5/8"	21/32"	11	10.1 lbs.

Meets U.S. 42 code

Art. 42/2 /US

Mtl 5/8" dia.  
D = 3 7/8"  
5/8" round holes  
17 holes  
Wt. 7 lbs.



Art. 42/4

Mtl 13/16" dia.  
P = 6 3/4"  
13/16" round holes  
11 holes  
Wt. 11 lbs.

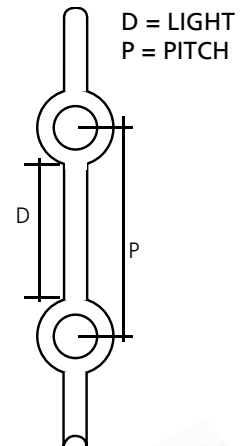

Pierced bar length 78 3/4" Approx.

Art. 605/1

Mtl 9/16" sq.  
Pitch = 5 1/2"  
holes per bar 14  
Wt. 6.6 lbs.  
match for 623/6

Art. 605/3

Mtl 23/32" sq.  
Pitch = 6 5/16"  
holes per bar 12  
Wt. 11 lbs.  
match for 623/8

Art. 605/2

Mtl 5/8" sq.  
Pitch = 5 7/8"  
holes per bar 13  
Wt. 8.8 lbs.  
match for 623/7

Art. 605/4

Mtl 13/16" sq.  
Pitch = 6 5/8"  
holes per bar 11  
Wt. 13.8 lbs.  
match for 623/9





Shown: 42/1

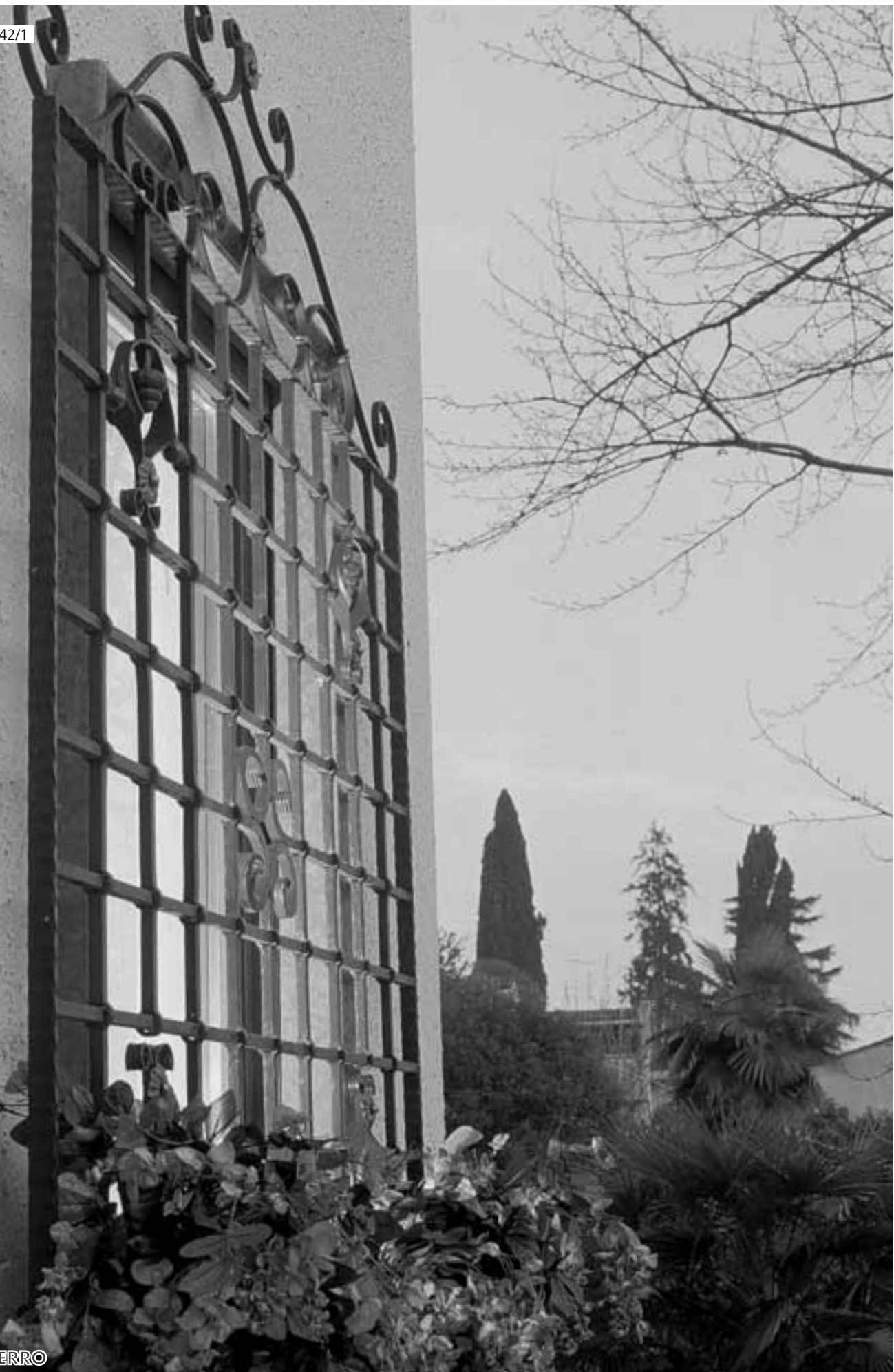

PIERCED BARS

ARTEFERRO



**GATE TOPS** Quick Reference # 7 2011





**Art. 116/D/1**  
 Mtl 3/4" x 1/4"  
 W 50 13/32"  
 H 17 23/32"  
 Wt. 7.44 lbs.



**Art. 116/D/2**  
 Mtl 3/4" x 1/4"  
 W 50 13/32"  
 H 17 23/32"  
 Wt. 7.88 lbs.



**Art. 1281/4**  
 Mtl 5/8" x 5/16"  
 W 29 15/16"  
 H 10 1/4"  
 Wt. 5.5 lbs.



**Art. 1281/3**  
 Mtl 5/8" x 5/16"  
 W 32 5/8"  
 H 13 3/8"  
 Wt. 6.5 lbs.



**Art. 116/E/6**  
 Mtl 1 3/16" x 5/16"  
 W 31 29/32"  
 H 11 1/32"  
 Wt. 10.1 lbs.



**Art. 696/1**  
 Mtl 5/8" x 5/16"  
 W 36 1/4"  
 H 11 1/32"  
 Wt. 8.2 lbs.



**Art. 1281/1**  
 Mtl 5/8" x 5/16"  
 W 51 3/16"  
 H 17 1/2"  
 Wt. 14.7 lbs.



**Art. 1281/2**  
 Mtl 5/8" x 5/16"  
 W 48 1/4"  
 H 17 1/2"  
 Wt. 13.6 lbs.

Shown: 1281/4





SHOES, BUSHINGS AND BASKETS

Quick Reference # 7 2011

Shown: 128/6



ARTEFERRO



**Art. 128/6**  
Mtl 1 9/16" W  
x 2 9/16" H  
Hole 1/2" dia.  
Wt. 0.4 lbs.



**Art. 128/9**  
Mtl 5/8" dia.  
Hole 5/8" dia.  
Wt. 0.7 lbs.



**Art. 128/17**  
Mtl 1 9/16" W  
x 1 17/32" H  
Hole 1/2" dia.  
Wt. 0.4 lbs.



**Art. 128/17**  
Mtl 1 9/16" W  
x 1 17/32" H  
Hole 1/2" dia.  
Wt. 0.3 lbs.



**Art. GD0030**  
Mtl 2 33/64" dia.  
2 3/4" H  
Hole 2/3" sq.  
Wt. 1 lbs.

**Art. 128/7**  
Mtl 1 9/16" W  
x 2 9/16" H  
Hole 9/16" dia.  
Wt. 0.5 lbs.

**Art. 128/10**  
Mtl 1 3/4"  
x 2 5/8"  
Hole 11/16" dia.  
Wt. 0.6 lbs.

**Art. 128/18**  
Mtl 1 9/16" W  
x 1 17/32" H  
Hole 9/16" dia.  
Wt. 0.3 lbs.

**Art. 128/18**  
Mtl 1 9/16" W  
x 1 17/32" H  
Hole 9/16" dia.  
Wt. 0.3 lbs.

**Art. 128/15**  
Mtl 1 31/32"  
x 3 1/16"  
Hole 7/8" dia.  
Wt. 0.6 lbs.

**Art. 128/21**  
Mtl 1 3/4" W  
x 1 23/32" H  
Hole 5/8" dia.  
Wt. 0.4 lbs.

**Art. 128/21**  
Mtl 1 3/4" W  
x 1 23/32" H  
Hole 1/2" dia.  
Wt. 0.5 lbs.



External dia.  
1 9/16" 29/32" H

**Art. 128/1**  
With round hole  
9/16" dia.  
Wt. .3 lbs.

**Art. 128/2**  
With square hole  
9/16" sq.  
Wt. .3 lbs.

**Art. 128/22**  
Mtl 1 3/4" W  
x 1 23/32" H  
Hole 11/16" dia.  
Wt. 0.4 lbs.

**Art. 128/22**  
Mtl 1 3/4" W  
x 22/32" H  
Wt. 0.4 lbs.

**Art. 128/28**  
Mtl 2" W  
x 1 13/16" H  
Hole 7/8" dia.  
Wt. 0.6 lbs.

**Art. 128/28**  
Mtl 2" W  
x 1 29/32" H  
Wt. 0.6 lbs.



**Art. GD0031**  
Mtl 2 33/64" dia.  
2 3/4" H  
Hole 2/3" sq.  
Wt. 1.5 lbs.

## Hollow Steel



**Art. 155/1**  
Mtl 1 3/16" W  
x 3 11/32" H  
Hole 33/64" dia.  
Wt. 0.2 lbs.



**Art. 155/2**  
Mtl 1 3/16" W  
x 2 9/16" H  
Hole 33/64" dia.  
Wt. 0.2 lbs.



**Art. 155/3**  
Mtl 1 3/16" W  
x 2" H  
Hole 33/64" dia.  
Wt. 0.2 lbs.



**Art. 155/4**  
Mtl 1 3/16" W  
x 3/4" H  
Hole 33/64" dia.  
Wt. 0.1 lbs.



**Art. 155/6**  
Mtl 1 3/16" W  
x 2 9/16" H  
Hole 33/64" dia.  
Wt. 0.2 lbs.



**Art. 154/2**  
Mtl 1 3/16" W  
x 5 7/8" H  
Hole 33/64" dia.  
Wt. 0.3 lbs.

Shown: 160/B/6



ARTEFERRO



**Art. 160/B/6**  
Mtl 2 3/4" x 2 9/16"  
Hole 1 9/16" dia.  
Wt. .7 lbs.



**Art. 160/B/7**  
Mtl 1 17/32" x 2 3/8"  
Hole 5/8" dia.  
Wt. 0.5 lbs.

MALLEABLE WELDABLE CAST IRON,  
GALVANIZING IS NOT RECOMMENDED



**Art. 1491/5**  
Mtl 2 3/4" W  
x 1 3/4" H  
Hole 1 1/16" sq.  
Wt. 1.3 lbs.



**Art. 1491/1**  
(shoes A12)  
Mtl 1 3/8" W  
x 2" H  
Hole 1/2" sq.  
Wt. 0.3 lbs.



**Art. 1491/2**  
(shoes A916)  
Mtl 1 3/16" W  
x 2" H  
Hole 5/8" sq.  
Wt. 0.2 lbs.



**Art. 746/6**  
Mtl 1 9/16" W  
x 1 1/2" H  
Hole 9/16" sq.  
Wt. 0.4 lbs.



**Art. 1491/3**  
(shoes R12)  
Mtl 1 9/16" W  
x 1 3/32" H  
Hole 1/2" sq.  
Wt. 0.3 lbs.



**Art. 1491/4**  
(shoes R916)  
Mtl 1 9/16" W  
x 1 3/32" H  
Hole 9/16" sq.  
Wt. 0.2 lbs.



**Art. 746/5**  
Mtl 1 9/16" W  
x 2 9/16" H  
Hole 9/16" sq.  
Wt. 0.5 lbs.



**Art. 746/6**  
Mtl 1 9/16" W  
x 1 1/2" H  
Hole 9/16" sq.  
Wt. 0.4 lbs.



**Art. 746/4**  
Mtl 1 29/32" W  
x 1 3/16" H  
Hole 5/8" sq.  
Wt. 0.4 lbs.



**Art. 747/10**  
Mtl 1 9/16" W  
x 2 3/4" H  
Hole 9/16" sq.  
Wt. 0.4 lbs.



**Art. 747/8**  
Mtl 1 9/16" W  
x 4 1/2" H  
Hole 9/16" sq.  
Wt. 0.4 lbs.



**Art. 747/12**  
Mtl 1 9/16" W  
x 2 9/16" H  
Hole 1/2" sq.  
Wt. 0.5 lbs.



**Art. 747/15**  
Mtl 1 9/16" W  
x 1 17/32" H  
Hole 1/2" sq.  
Wt. 0.3 lbs.

**Art. 747/11**  
Mtl 1 9/16" W  
x 2 3/4" H  
Hole 1/2" sq.  
Wt. 0.4 lbs.

**Art. 747/9**  
Mtl 1 9/16" W  
x 4 17/32" H  
Hole 1/2" sq.  
Wt. 0.4 lbs.

**Art. 747/13**  
Mtl 1 3/4" W  
x 2 21/32" H  
Hole 9/16" sq.  
Wt. 0.7 lbs.

**Art. 747/16**  
Mtl 1 3/4" W  
x 1 11/16" H  
Hole 9/16" sq.  
Wt. 0.6 lbs.

**Art. 747/14**  
Mtl 2" W  
x 3 1/16" H  
Hole 5/8" sq.  
Wt. 1 lbs.

**Art. 747/17**  
Mtl 2" W  
x 3 1/16" H  
Hole 5/8" sq.  
Wt. 0.7 lbs.



Shown: 746/5

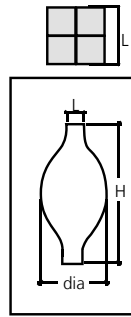

- Art. 159/1** L = 5/16"  
1 3/8" dia. x 3 9/16" H - Wt. 0.1 lbs.
- Art. 159/3** L = 1/2"  
2 3/8" dia. x 5 1/8" H - Wt. 0.5 lbs.
- Art. 159/4** L = 9/16"  
2 3/8" dia. x 5 1/8" H - Wt. 0.7 lbs.
- Art. 159/5** L = 5/8"  
2 9/16" dia. x 5 3/4" H - Wt. 0.9 lbs.
- Art. 159/6** L = 3/4"  
3 1/8" dia. x 6 1/2" H - Wt. 1.5 lbs.
- Art. 159/7** L = 15/16"  
2 3/4" dia. x 7 1/16" H - Wt. 2.7 lbs.



**Art. 158/B/7**  
Mtl 1/4" sq.  
2 3/4" dia.  
Wt. 0.5 lbs.



**Art. 158/B/6**  
Mtl 1/4" sq.  
2 3/4" dia.  
Wt. 0.5 lbs.

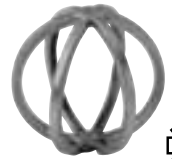

**Art. 1163/12**  
Mtl 1/4" sq.  
3 9/16" dia.  
Wt. 0.4 lbs.



4 Filaments  
**Art. 158/B/8**  
L 1/2" sq.  
1 9/16" dia.  
x 4 15/16" H  
Wt. 0.5 lbs.



9 Filaments  
**Art. 158/B/1**  
L 1/2" sq.  
2 1/8" dia.  
x 5 1/8" H  
Wt. 0.4 lbs.

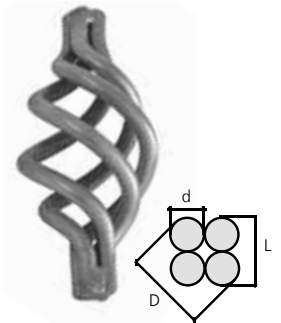

4 Round filaments  
**Art. 1163/3**  
d 1/4"  
D 37/64"  
L 1/2" x 4 15/16"  
Wt. 0.4 lbs.  
**Art. 1163/4**  
d 9/32"  
D 21/32"  
L 9/16" x 4 15/16"  
Wt. 0.5 lbs.

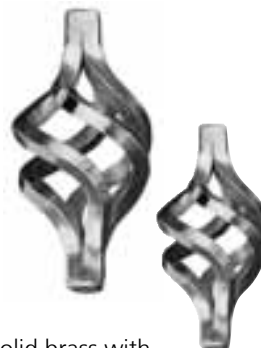

Solid brass with threaded ends

**SOLID BRASS BASKETS**

- Art. 160/L/1**  
Mtl 1/2" sq.  
2 3/4" x 5 7/8"  
Wt. 0.5 lbs.
- Art. 160/L/2**  
Mtl 5/8" sq.  
2 3/4" x 5 7/8"  
Wt. 0.9 lbs.
- Art. 160/L/3**  
Mtl 3/4" sq.  
2 3/4" x 5 7/8"  
Wt. 1.6 lbs.



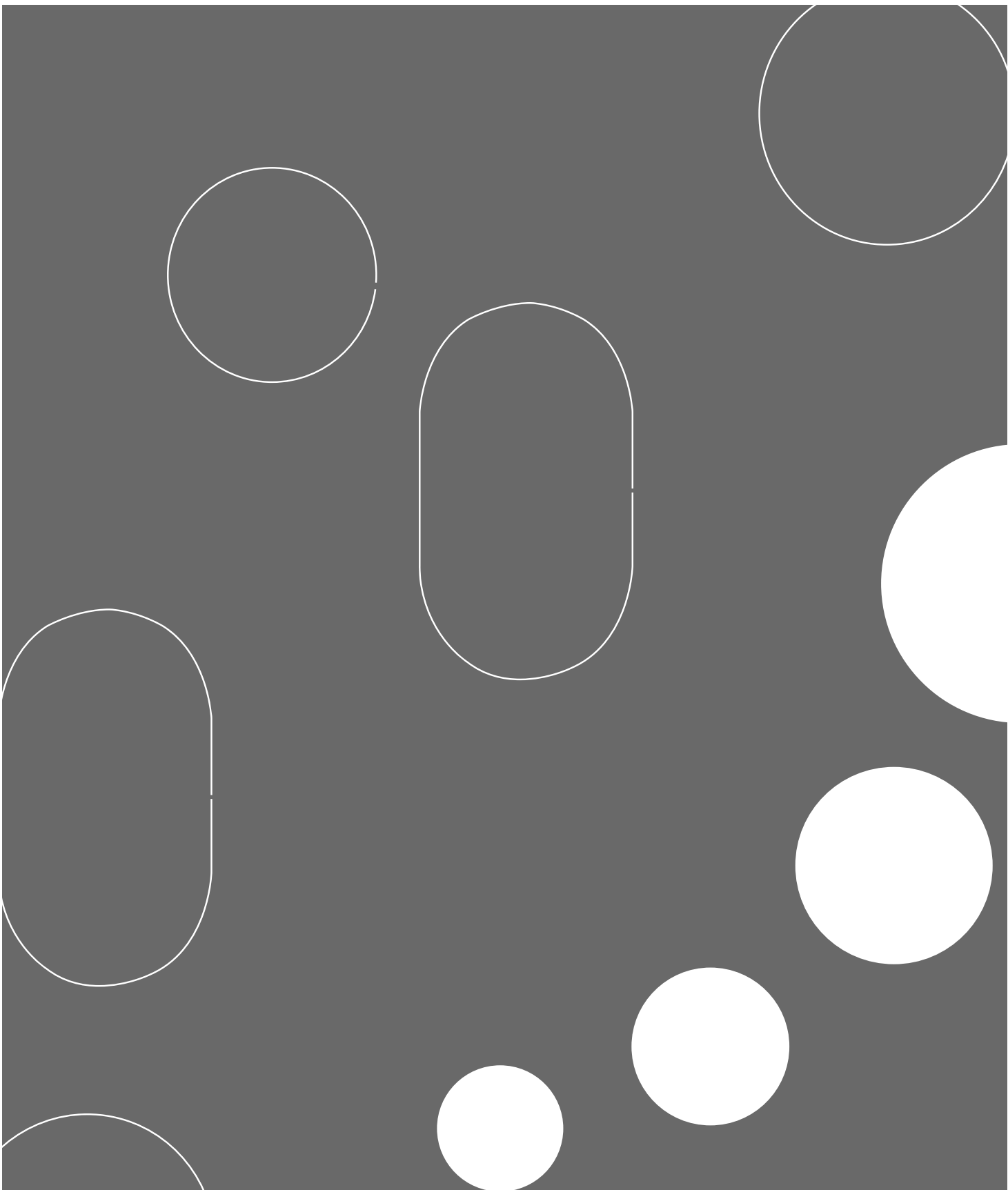

**RINGS AND SPHERES** Quick Reference # 7 2011

Art. 491/8    Art. 116/F/1  
Art. 1317/13    Art. 116/F/2  
Art. 1320/1    Art. 116/F/3  
Art. 116/F/4

# New Items



**Art. 684/6**  
Mtl 5/8" x 5/16" dia.  
3" dia.  
Wt. 0.5 lbs.



**Art. 1299/5**  
Mtl 1/2" x 1/4" dia.  
3 15/16" dia.  
Wt. 0.5 lbs.



**Art. 1299/6**  
Mtl 1/2" x 1/4" dia.  
5 1/8" dia.  
Wt. 0.7 lbs.



**Art. 491/7**  
Mtl 11/16" x 1/2" dia.  
3 11/32" dia.  
Wt. 0.54 lbs.



**Art. 156/3**  
Mtl 1/2" sq.  
W 5 1/8"  
H 7"  
Wt. 1.0 lbs.



**Art. 156/6**  
Mtl 9/16" sq.  
W 7 9/16"  
H 10 3/4"  
Wt. 2.0 lbs.

Shown: 491/7



ARTEFERRO



**Art. 1317/3**  
Mtl 1/2" sq.  
W 3 15/16"  
H 7 1/2"  
Wt. 1.12 lbs.



**Art. 1318/9**  
Mtl 1/2" sq.  
W 4"  
H 7 1/2"  
Wt. 1.12 lbs.

Shown: 491/7



ARTEFERRO

Shown: 1318/9



ARTEFERRO

Shown: 491/9

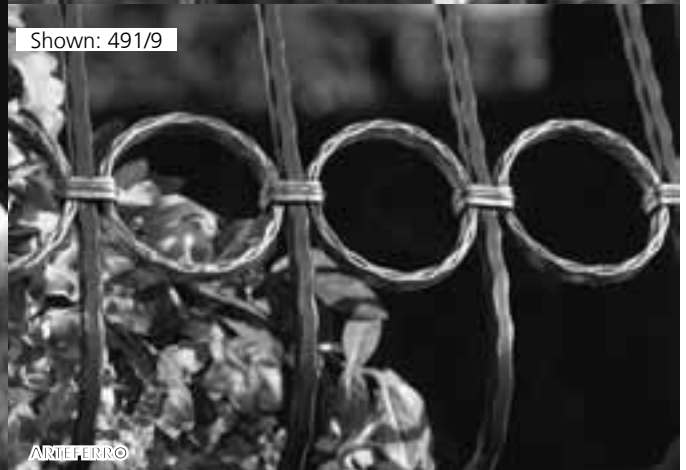

ARTEFERRO

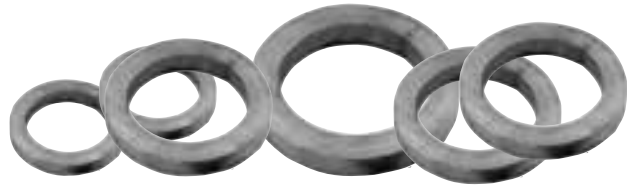

**Art. 481/D/89**

Mtl 15/32" sq.  
3 1/2" dia.  
Wt. 0.5 lbs.

**Art. 481/D/127**

(ex 157/3/S)  
Mtl 1/2" sq.  
5" dia. Plain  
Wt. 0.8 lbs.

**Art. 481/8/D/133**

(ex 157/3/S/1)  
Mtl 1/2" sq.  
5 1/4" dia.  
Wt. 0.9 lbs.

**Art. 481/8/D/140**

(ex 157/3/S/2)  
Mtl 1/2" sq.  
5 1/2" dia.  
Wt. 0.9 lbs.

**Art. 481/8**

(ex 157/1/S)  
Mtl 1/2" sq.

3 15/16" dia. Plain

Wt. 0.6 lbs.

**Art. 1317/1**

(ex 157/2/S)  
Mtl 1/2" sq.

4 1/2" dia.

Wt. 0.8 lbs.

**Art. 1317/2**

Mtl 1/2" sq.  
5 1/8" dia.

Wt. 0.9 lbs.

Outside Dia.	11/16" x 11/16"	Wt. lbs.	3/4" x 3/4"	Wt. lbs.
5 1/8"	<b>1802/4</b>	0.88	<b>1802/85</b>	1.05
6 19/64"	<b>1802/91</b>	1.13	<b>1802/92</b>	1.38
7 3/32"	<b>1802/99</b>	1.28	<b>1802/100</b>	1.57
7 7/8"	<b>1802/108</b>	1.44	<b>1802/109</b>	1.75

Outside Dia.	1" x 1"	Wt. lbs.	1 3/16" x 1 3/16"	Wt. lbs.
5 1/8"				
6 19/64"	<b>1802/93</b>	4.2		
7 3/32"	<b>1802/101</b>	5.1	<b>1802/102</b>	3.15
7 7/8"	<b>1802/110</b>	5.9	<b>1802/111</b>	3.07

\* SIZE REFERS TO INSIDE WIDTH OF THE RING

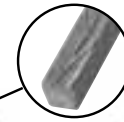

Art. 623/5



\* **Art. 156/A/1**  
Mtl 1/4" x 1/4"  
1" dia.

Wt. 0.1 lbs.

\* **Art. 156/A/3**

Mtl 1/4" x 1/4"  
1 9/16" dia.  
Wt. 0.1 lbs.



**Art. 1317/8**

Mtl 3/8" dia.  
5 1/8" dia.  
Wt. 0.5 lbs.



\* **Art. 156/A/4**

Mtl 1/4" x 1/4"  
2" dia.  
Wt. 0.1 lbs.

\* **Art. 156/A/5**

Mtl 1/4" x 1/4"  
2 31/64" dia.  
Wt. 0.1 lbs.



**Art. 1317/18**

Mtl 1/2" sq.  
3 15/16" dia.  
Wt. 0.7 lbs.

**Art. 1317/19**

Mtl 1/2" sq.  
4 1/2" dia.  
Wt. 0.8 lbs.

**Art. 1317/20**

Mtl 1/2" sq.  
3 1/8" dia.  
Wt. 0.9 lbs.

**Art. 157/1**

Mtl 1/2" x 1/4"  
3 15/16" dia.  
Wt. 0.4 lbs.

**Art. 157/2**

Mtl 1/2" x 1/4"  
4 1/2" dia.  
Wt. 0.4 lbs.

**Art. 157/3**

Mtl 1/2" x 1/4"  
5 1/8" dia.  
Wt. 0.4 lbs.



**Art. 157/16**

Mtl 1/2" x 1/4"  
4 1/2" x 6 5/16"  
Wt. 0.5 lbs.



**Art. 156/A/6**

Mtl 3/16" x 3/16"  
2 31/64" dia.  
Wt. 0.1 lbs.



**Art. 491/9**

Mtl 1/2" sq.  
3 15/16" dia.  
Hammered edges  
Wt. 0.6 lbs.



**HOT STAMPED SPHERES**

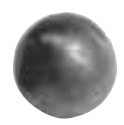

- Art. 116/F/1** Mtl 3/4" dia. Wt. .08 lbs.
- Art. 116/F/2** Mtl 1" dia. Wt. 0.1 lbs.
- Art. 116/F/3** Mtl 1 3/16" dia. Wt. 0.3 lbs.
- Art. 123/1** Mtl 1 3/8" dia. Wt. 0.3 lbs.
- Art. 116/F/4** Mtl 1 9/16" dia. Wt. 0.6 lbs.
- Art. 116/F/5** Mtl 2" dia. Wt. 1.3 lbs.
- Art. 116/F/6** Mtl 2 3/8" dia. Wt. 1.9 lbs.
- Art. 116/F/8** Mtl 3 1/8" dia. Wt. 3.3 lbs.
- Art. 116/F/10** Mtl 3 15/16" dia. Wt. 8.8 lbs.



- Art. 117/1** Mtl 5/8" dia. Wt. .04 lbs.
- Art. 117/2** Mtl 3/4" dia. Wt. 0.1
- Art. 117/3** Mtl 1" dia. Wt. 0.15 lbs.
- Art. 117/4** Mtl 1 3/16" dia. Wt. 0.3 lbs.
- Art. 117/5** Mtl 1 3/8" dia. Wt. 0.33 lbs.
- Art. 117/6** Mtl 1 9/16" dia. Wt. .5 lbs.
- Art. 117/7** Mtl 2" dia. Wt. 1.1 lbs.
- Art. 117/8** Mtl 2 3/8" dia. Wt. 2 lbs.
- Art. 117/9** Mtl 2 3/4" dia. Wt. 3.1 lbs.



- Art. 113/11** 3 15/16" dia. Wt. 8.8 lbs.
- Art. 113/12** 3 1/8" dia. Wt. 5 lbs.

**FORGED SPHERES**

Shown: 491/9



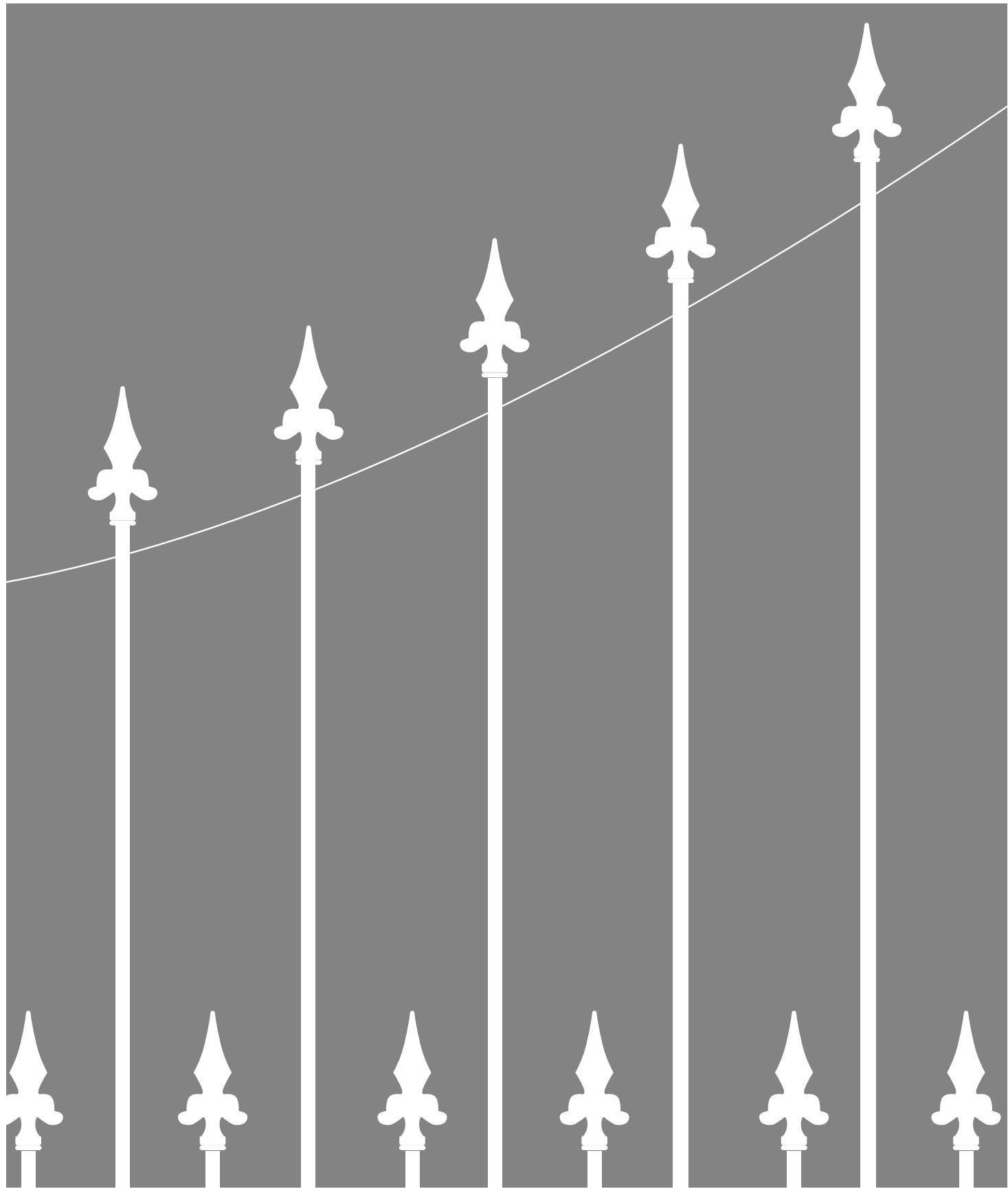

# SPEAR POINTS

Quick Reference # 7 2011





Art. 120/1  
Mtl 1 19/32" dia.  
H 8 11/16"  
Wt. 1.4 lbs.



Art. 120/2  
Mtl 1 3/8" dia.  
H 7 7/8"  
Wt. 1.3 lbs.



Art. 122/A/1  
Mtl 1 1/4" dia.  
H 7 7/8"  
Wt. 1.0 lbs.



Art. 120/3  
Mtl 1 3/16" dia.  
H 6 11/16"  
Wt. 0.7 lbs.



Art. 125/2  
Mtl 9/16" sq.  
H 5 1/2"  
Wt. 0.8 lbs.



Art. 125/1  
Mtl 1 3/8" dia.  
H 4 15/16"  
Wt. 0.7 lbs.

Shown: 120/3





**Art. 126/1**  
Mtl 3/8" sq.  
H 5 1/2"  
Wt. 0.5 lbs.



**Art. 124/1**  
Mtl 1/2" dia.  
H 4 15/16"  
Wt. 0.4 lbs.  
**Art. 124/2**  
Mtl 19/32" dia.  
H 6 5/16"  
Wt. 0.6 lbs.  
**Art. 124/9**  
Mtl 3/4" dia.  
H 7 1/2"  
Wt. 0.7 lbs.



**Art. 126/A/1**  
Mtl 19/32" dia.  
W 2 21/32"  
H 5 19/32"  
Wt. 0.6 lbs.



**Art. 126/15**  
Mtl 1 3/16" dia.  
H 6 5/16"  
1 1/8" Base  
Wt. 1.5 lbs.



**Art. 123/5**  
Mtl 1" dia.  
H 6 5/16"  
1 1/8" Base  
Wt. 0.8 lbs.

**Art. 126/16**  
Mtl 1 9/16" dia.  
H 7 15/32"  
1/2" Base  
Wt. 2.5 lbs.



Shown: 124/1





**Art. 724/1**  
Mtl 1 1/4" dia.  
H 11 19/32"  
Wt. 4.2 lbs.



**Art. 121/4**  
Mtl 1 9/32" dia.  
H 5 1/8"  
Wt. 0.7 lbs.  
**Art. 726/3**  
Mtl 1 9/16" dia.  
H 6 5/16"  
Wt. 0.8 lbs.



**Art. 121/5**  
Mtl 1" sq.  
H 6 5/16"  
Wt. 1.0 lbs.



**Art. 121/6**  
Mtl 1 3/16" sq.  
H 7 5/16"  
Wt. 1.5 lbs.  
**Art. 121/7**  
Mtl 1 9/16" sq.  
H 7 5/16"  
Wt. 2.2 lbs.



**Art. 121/8**  
Mtl 1 3/16" sq.  
H 6 1/32"  
Wt. 1.4 lbs.  
**Art. 121/9**  
Mtl 1 9/16" sq.  
H 6 1/32"  
Wt. 2.6 lbs.

Shown: 724/1





**Art. 727/4**  
Mtl 1 3/16" dia.  
W 3 5/32"  
H 8 9/32"  
Wt. 1.3 lbs.



**Art. 727/1**  
Mtl 1 1/4" dia.  
W 2 3/4"  
H 5 1/2"  
Wt. 0.7 lbs.



**Art. 126/B/1**  
Mtl 3/4" dia.  
W 3 7/32"  
H 7 21/32"  
Wt. 0.8 lbs.



**Art. 126/13**  
Mtl 5/8" dia.  
W 2 1/2"  
H 6 11/16"  
Wt. 0.9 lbs.



**Art. 727/7**  
Mtl 1 9/16" sq.  
W 4 23/32"  
H 4 3/4"  
Wt. 2.8 lbs.



**Art. 126/B/6**  
Mtl 3/4" dia.  
W 1 3/4"  
H 3 5/32"  
Wt. 0.3 lbs.



**Art. 126/6**  
Mtl 1 11/32" dia.  
H 7 15/32"  
Wt. 0.8 lbs.

**Art. 727/5**  
Mtl 1 1/16" dia.  
W 2 3/4"  
H 7 9/32"  
Wt. 0.9 lbs.

**Art. 727/2**  
Mtl 1 3/16" dia.  
W 2 9/16"  
H 4 29/32"  
Wt. 0.5 lbs.

**Art. 126/B/2**  
Mtl 5/8" dia.  
W 2 21/32"  
H 6 9/32"  
Wt. 0.6 lbs.

**Art. 126/14**  
Mtl 9/16" dia.  
W 2 5/32"  
H 5 1/2"  
Wt. 0.5 lbs.

**Art. 727/8**  
Mtl 1 1/4" sq.  
W 3 17/32"  
H 6 5/16"  
Wt. 1.4 lbs.

**Art. 126/B/7**  
Mtl 1" dia.  
W 2 1/2"  
H 4 29/32"  
Wt. 0.7 lbs.

**Art. 126/19**  
Mtl 1" dia.  
H 5 1/2"  
Wt. 0.4 lbs.

**Art. 727/6**  
Mtl 15/16" dia.  
W 2 3/8"  
H 6 5/16"  
Wt. 0.7 lbs.

**Art. 727/3**  
Mtl 1" dia.  
W 2 5/32"  
H 4 5/16"  
Wt. 0.4 lbs.

**Art. 126/B/3**  
Mtl 1/2" dia.  
W 2 1/8"  
H 5 3/32"  
Wt. 0.3 lbs.

**Art. 727/9**  
Mtl 1" sq.  
W 2 3/4"  
H 4 23/32"  
Wt. 0.6 lbs.

**Art. 126/B/8**  
Mtl 1 1/2" dia.  
W 3 5/32"  
H 5 1/2"  
Wt. 0.9 lbs.

**Art. 126/20**  
Mtl 1 3/16" dia.  
H 6 5/16"  
Wt. 0.9 lbs.



**Art. 126/C/7**  
Mtl 23/32" dia.  
H 4 15/16"  
Wt. 0.8 lbs.



**Art. 727/10**  
Mtl 1 9/32" dia.  
W 1 9/16"  
H 5 7/8"  
Wt. 0.9 lbs.



**Art. 727/11**  
Mtl 1 3/16" dia.  
W 1 1/4"  
H 4 23/32"  
Wt. 0.5 lbs.



**Art. 123/3**  
Mtl 1 1/4" dia.  
H 5 1/8"  
Wt. 0.7 lbs.



**Art. 126/18**  
Mtl 1 9/16" dia.  
H 5 29/32"  
Wt. 2.1 lbs.



**Art. 123/6**  
Mtl 1 3/8" dia.  
H 7 3/32"  
Wt. 0.84 lbs.



**Art. 123/B/5**  
Mtl 2" dia.  
W 3 11/32"  
H 6 5/8"  
Wt. 2.5 lbs.

Shown: 1382/2



ARTEFERRO

HAND FORGED

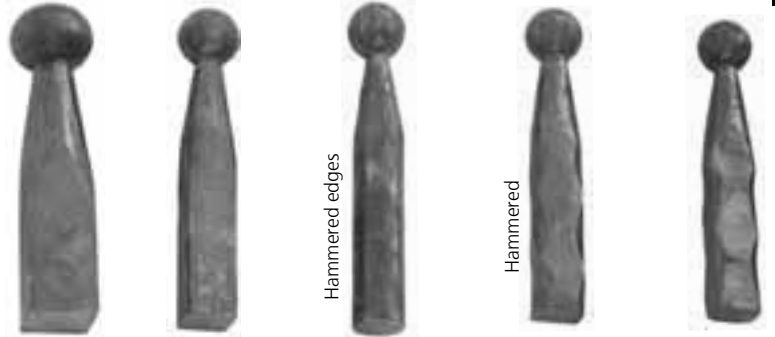

- |   |   |   |   |  |
|---|---|---|---|--|
| <b>Art. 1382/1</b><br>Mtl 1 9/16" sq.<br>H 7 7/8"<br>Wt. 5.5 lbs. | <b>Art. 1382/2</b><br>Mtl 1" sq.<br>H 7 7/8"<br>Wt. 2.2 lbs.      | <b>Art. 1382/4</b><br>Mtl 1" dia.<br>H 7 7/8"<br>Wt. 1.8 lbs.     | <b>Art. 1382/6</b><br>Mtl 1" sq.<br>H 7 7/8"<br>for 118/6<br>Wt. 2.2 lbs.       | <b>Art. 1382/9</b><br>Mtl 1" sq.<br>H 7 7/8"<br>for 180/53<br>Wt. 2.5 lbs.       |
|   | <b>Art. 1382/3</b><br>Mtl 1 3/16" sq.<br>H 7 7/8"<br>Wt. 3.1 lbs. | <b>Art. 1382/5</b><br>Mtl 1 3/16" sq.<br>H 7 7/8"<br>Wt. 2.5 lbs. | <b>Art. 1382/7</b><br>Mtl 1 3/16" sq.<br>H 7 7/8"<br>for 118/24<br>Wt. 3.1 lbs. | <b>Art. 1382/10</b><br>Mtl 1 3/16" sq.<br>H 7 7/8"<br>for 180/50<br>Wt. 3.1 lbs. |
|   |   |   | <b>Art. 1382/8</b><br>Mtl 1 9/16" sq.<br>H 7 7/8"<br>for 118/25<br>Wt. 5.5 lbs. |  |



**Art. 1382/11**  
Mtl 1/2" dia.  
H 7 7/8"  
Wt. 0.4 lbs.



**Art. 1382/13**  
Mtl 1/2" dia.  
H 7 7/8"  
Wt. 0.4 lbs.



**Art. 1382/15**  
Mtl 1/2" sq.  
H 7 7/8"  
Wt. 0.4 lbs.



**Art. 1382/17**  
Mtl 1/2" sq.  
H 7 7/8"  
Wt. 0.5 lbs.



**Art. 1382/19**  
Mtl 1/2" sq.  
H 7 7/8"  
Wt. 0.5 lbs.



**Art. 1382/21**  
Mtl 1/2" sq.  
H 7 7/8"  
Wt. 0.5 lbs.

**Art. 1382/12**  
Mtl 9/16" dia.  
H 7 7/8"  
Wt. 0.5 lbs.

**Art. 1382/14**  
Mtl 9/16" dia.  
H 7 7/8"  
Wt. 0.5 lbs.

**Art. 1382/16**  
Mtl 9/16" sq.  
H 7 7/8"  
Wt. 0.5 lbs.

**Art. 1382/18**  
Mtl 9/16" sq.  
H 7 7/8"  
Wt. 0.7 lbs.

**Art. 1382/20**  
Mtl 9/16" sq.  
H 7 7/8"  
Wt. 0.7 lbs.

**Art. 1382/22**  
Mtl 9/16" sq.  
H 7 7/8"  
Wt. 0.7 lbs.

Pickets with post tops

Custom heights available by request

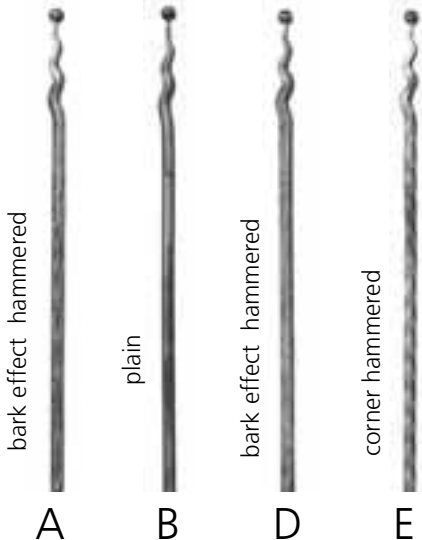

- |                     |               |           |              |
|---------------------|---------------|-----------|--------------|
| <b>Art. 1259/1</b>  | Mtl 1/2" sq.  | H 39 3/8" | Wt. 2 lbs.   |
| <b>Art. 1259/2</b>  | Mtl 9/16" sq. | H 39 3/8" | Wt. 2.6 lbs. |
| <b>Art. 1259/3</b>  | Mtl 1/2" sq.  | H 47 1/4" | Wt. 2.4 lbs. |
| <b>Art. 1259/4</b>  | Mtl 9/16" sq. | H 47 1/4" | Wt. 3.2 lbs. |
| <b>Art. 1259/5</b>  | Mtl 1/2" sq.  | H 39 3/8" | Wt. 2 lbs.   |
| <b>Art. 1259/6</b>  | Mtl 9/16" sq. | H 39 3/8" | Wt. 2.6 lbs. |
| <b>Art. 1259/7</b>  | Mtl 1/2" sq.  | H 47 1/4" | Wt. 2.4 lbs. |
| <b>Art. 1259/8</b>  | Mtl 9/16" sq. | H 47 1/4" | Wt. 3.2 lbs. |
| <b>Art. 1259/13</b> | Mtl 1/2" sq.  | H 39 3/8" | Wt. 2.5 lbs. |
| <b>Art. 1259/14</b> | Mtl 9/16" sq. | H 39 3/8" | Wt. 3.4 lbs. |
| <b>Art. 1259/15</b> | Mtl 1/2" sq.  | H 47 1/4" | Wt. 3 lbs.   |
| <b>Art. 1259/16</b> | Mtl 9/16" sq. | H 47 1/4" | Wt. 4.1 lbs. |
| <b>Art. 1259/19</b> | Mtl 1/2" sq.  | H 47 1/4" | Wt. 3 lbs.   |
| <b>Art. 1259/20</b> | Mtl 9/16" sq. | H 47 1/4" | Wt. 4.1 lbs. |

Shown: 1259/1



ARTEFERRO

## Forged Spear Points



**Art. 129/1**  
Mtl 9/16" sq.  
H 7 7/8"  
Wt. 0.5 lbs.



**Art. 129/3**  
Mtl 9/16" sq.  
H 7 15/32"  
Wt. 0.5 lbs.



**Art. 129/5**  
Mtl 9/16" sq.  
H 4 5/16"  
Wt. 0.5 lbs.



**Art. 129/7**  
Mtl 9/16" sq.  
H 8 5/8"  
Wt. 0.5 lbs.



**Art. 129/9**  
Mtl 9/16" sq.  
H 6 11/16"  
Wt. 0.3 lbs.



**Art. 129/12**  
Mtl 1/2" sq.  
H 7 7/8"  
Wt. 0.4 lbs.



**Art. 722/1**  
Mtl 1/2" sq.  
H 7 7/8"  
Wt. 0.3 lbs.

**Art. 129/2**  
Mtl 1/2" sq.  
H 7 15/32"  
Wt. 0.4 lbs.

**Art. 129/4**  
Mtl 1/2" sq.  
H 7 3/32"  
Wt. 0.4 lbs.

**Art. 129/6**  
Mtl 1/2" sq.  
H 3 15/16"  
Wt. 0.4 lbs.

**Art. 129/8**  
Mtl 1/2" sq.  
H 7 7/8"  
Wt. 0.4 lbs.

**Art. 129/10**  
Mtl 9/16" sq.  
H 5 29/32"  
Wt. 0.2 lbs.

**Art. 129/11**  
Mtl 9/16" sq.  
H 9 1/16"  
Wt. 0.5 lbs.

**Art. 722/2**  
Mtl 9/16" sq.  
H 9"  
Wt. 0.5 lbs.



**Art. 722/3**  
Mtl 1/2" sq.  
H 7 7/8"  
Wt. 0.4 lbs.



**Art. 722/5**  
Mtl 1/2" sq.  
H 5 29/32"  
Wt. 0.4 lbs.



**Art. 1385/4**  
Mtl 1/2" dia.  
H 7 7/8"  
Wt. 0.4 lbs.



**Art. 1385/7**  
Mtl 1/2" dia.  
H 7 7/8"  
Wt. 0.4 lbs.



**Art. 1385/10**  
Mtl 1/2" dia.  
H 7 7/8"  
Wt. 0.4 lbs.



**Art. 1385/13**  
Mtl 1/2" dia.  
H 7 7/8"  
Wt. 0.4 lbs.



**Art. 1765/16**  
(ex 9164/1)  
Mtl 9/16" sq.  
H 7 7/8"  
Wt. 0.7 lbs.



**Art. 1765/31**  
(ex 9164/3)  
Mtl 9/16" sq.  
H 7 7/8"  
Wt. 0.7 lbs.



**Art. 1765/46**  
(ex 9164/5)  
Mtl 9/16" sq.  
H 7 7/8"  
Wt. 0.7 lbs.

**Art. 722/4**  
Mtl 9/16" sq.  
H 8 21/32"  
Wt. 0.4 lbs.

**Art. 722/6**  
Mtl 9/16" sq.  
H 6 11/16"  
Wt. 0.3 lbs.

**Art. 1385/5**  
Mtl 9/16" dia.  
H 7 7/8"  
Wt. 0.5 lbs.

**Art. 1385/8**  
Mtl 9/16" dia.  
H 7 7/8"  
Wt. 0.5 lbs.

**Art. 1385/11**  
Mtl 9/16" dia.  
H 7 7/8"  
Wt. 0.5 lbs.

**Art. 1385/14**  
Mtl 9/16" dia.  
H 7 7/8"  
Wt. 0.5 lbs.

**Art. 1765/11**  
(ex 9164/2)  
Mtl 1/2" sq.  
H 7 7/8"  
Wt. 0.5 lbs.

**Art. 1765/26**  
(ex 9164/4)  
Mtl 1/2" sq.  
H 7 7/8"  
Wt. 0.5 lbs.

**Art. 1765/41**  
(ex 9164/6)  
Mtl 1/2" sq.  
H 7 7/8"  
Wt. 0.5 lbs.

**Art. 1385/6**  
Mtl 5/8" dia.  
H 7 7/8"  
Wt. 0.7 lbs.

**Art. 1385/9**  
Mtl 5/8" dia.  
H 7 7/8"  
Wt. 0.7 lbs.

**Art. 1385/12**  
Mtl 5/8" dia.  
H 7 7/8"  
Wt. 0.7 lbs.

**Art. 1385/15**  
Mtl 5/8" dia.  
H 7 7/8"  
Wt. 0.7 lbs.

## Hot Stamped Steel Spear Points



**Art. 1386/1**  
Mtl 1 19/32" sq.  
H 5 29/32"  
Wt. 2.1 lbs.



**Art. 1386/3**  
Mtl 1" sq.  
H 4 15/16"  
Wt. 0.6 lbs.



**Art. 1386/5**  
Mtl 9/16" sq.  
W 1 13/16"  
H 5 1/2"  
Wt. 0.4 lbs.



**Art. 1386/7**  
Mtl 5/8" dia.  
W 2 3/4"  
H 6 1/8"  
Wt. 0.7 lbs.



**Art. 1386/9**  
Mtl 1" dia.  
W 2 3/4"  
H 5 1/2"  
Wt. 0.4 lbs.



**Art. 1386/11**  
Mtl 5/8" dia.  
2 15/32" W x  
5 29/32" H  
Wt. 0.6 lbs.



**Art. 1386/12**  
Mtl 1 1/4" dia.  
W 2 3/8"  
H 4 15/16"  
Wt. 0.5 lbs.

**Art. 1386/2**  
Mtl 1 1/4" sq.  
H 5 5/16"  
Wt. 1.5 lbs.

**Art. 1386/4**  
Mtl 13/16" sq.  
H 3 15/16"  
Wt. 0.3 lbs.

**Art. 1386/6**  
Mtl 1/2" sq.  
W 1 21/32"  
H 4 3/4"  
Wt. 0.3 lbs.

**Art. 1386/8**  
Mtl 1/2" dia.  
W 2 3/8"  
H 5 1/8"  
Wt. 0.4 lbs.

**Art. 1386/10**  
Mtl 27/32" dia.  
W 2 3/8"  
H 4 17/32"  
Wt. 0.3 lbs.

**Art. 1386/13**  
Mtl 1" dia.  
W 2 3/16"  
H 4 11/32"  
Wt. 0.4 lbs.



**Art. 124/3**  
Mtl 1/2" dia.  
H 4 29/32"  
Wt. 0.3 lbs.



**Art. 124/7**  
Mtl 9/16" dia.  
H 5"  
Wt. 0.3 lbs.



**Art. 124/6**  
Mtl 19/32" dia.  
H 6 6/32"  
Wt. 0.7 lbs.



**Art. 126/E/1**  
Mtl 19/32" dia.  
W 2 5/32"  
H 5 29/32"  
Wt. 0.6 lbs.



**Art. 124/8**  
Mtl 19/32" dia.  
H 8 3/16"  
Wt. 1.2 lbs.



**Art. 123/7**  
Mtl 1 9/16" dia.  
H 7 7/8"  
Wt. 1.1 lbs.



**Art. 125/4**  
Mtl 3/4" dia.  
H 5 1/8"  
Wt. 0.7 lbs.



**Art. 89/4**  
Mtl 5/16" sq.  
H 2 1/8"  
Wt. 0.1 lbs.

**Art. 124/4**  
Mtl 19/32" dia.  
H 6 5/16"  
Wt. 0.7 lbs.

**Art. 124/5**  
Mtl 3/4" dia.  
H 7 5/32"  
Wt. 1.2 lbs.



**Art. 126/B/9**  
Mtl 27/32" dia.  
W 2 19/32"  
H 6 5/8"  
Wt. 1.0 lbs.



**Art. 126/B/4**  
Mtl 3/4" dia.  
W 2 27/32"  
H 5 3/32"  
Wt. 0.5 lbs.



**Art. 725/1**  
Mtl 1 3/16" dia.  
H 6 5/8"  
Wt. 1.3 lbs.



**Art. 725/5**  
Mtl 1 1/16" dia.  
H 8 21/32"  
Wt. 2.2 lbs.



Shown: 725/2



**Art. 725/2**  
Mtl 1 1/4" dia.  
H 8 7/8"  
Wt. 2.3 lbs.



**Art. 725/3**  
Mtl 3/4" sq.  
H 11 1/4"  
Wt. 3.05 lbs.



**Art. 725/4**  
Mtl 2"  
H 9 1/4"  
Wt. 2 lbs.

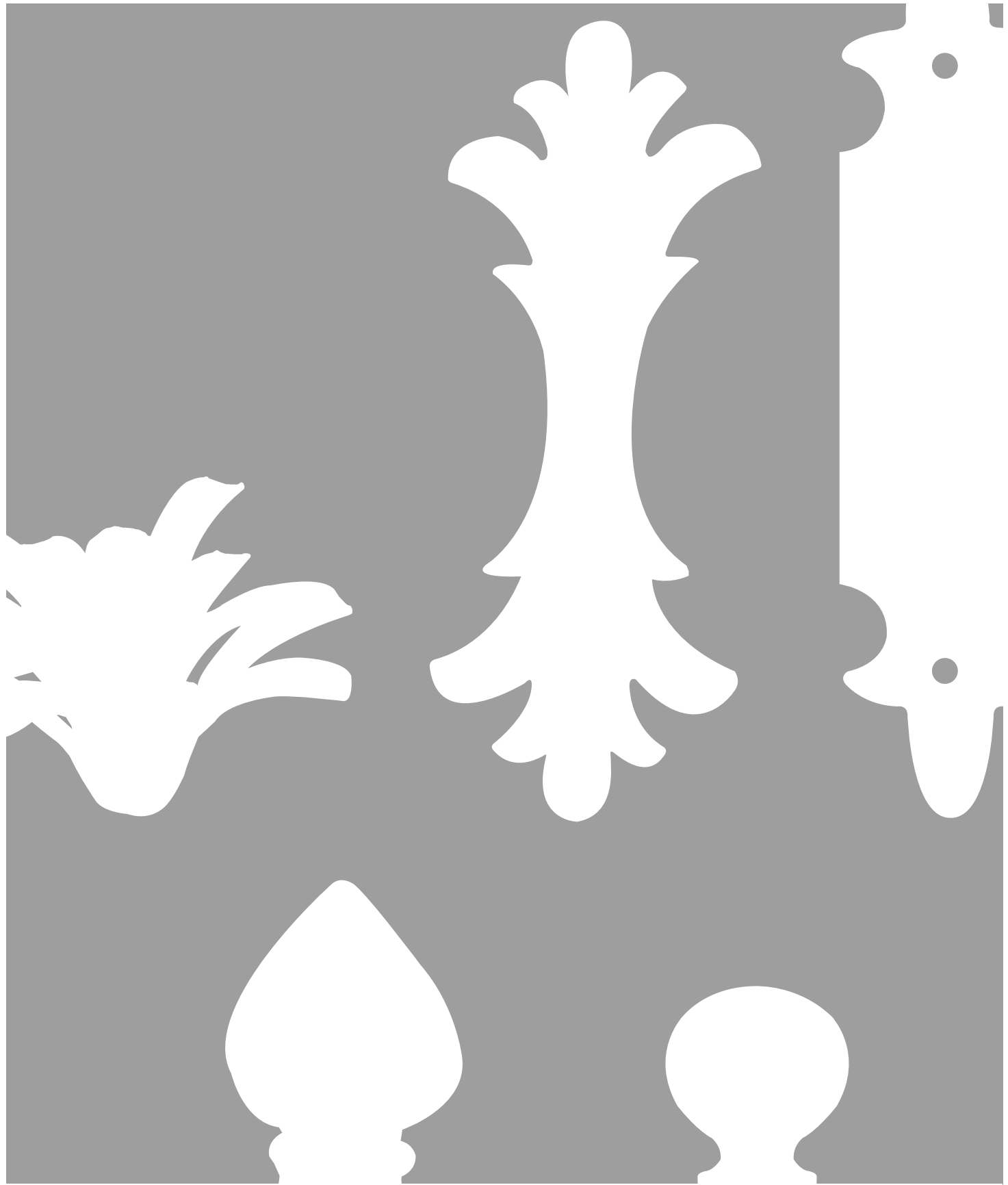

FINIALS AND PLATES

Quick Reference # 7 2011



**Art. 1408/1**  
Mtl 3 1/8" sq.  
Hole 1 1/32"  
Wt. 0.4 lbs.



**Art. 1408/2**  
Mtl 2 1/8" sq.  
Hole 5/8"  
Wt. 0.2 lbs.



**Art. 181/6**  
Mtl 5/16"  
4 3/4" sq.  
Wt. 0.2 lbs.

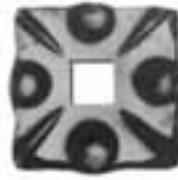

**Art. SHOE 94/A/6/S1**  
Mtl 5/16"  
3 1/8" sq.  
Hole 1" sq.  
Wt. 0.8 lbs.



**Art. 819/2/5 (SHOE 1)**  
Mtl 3 1/8" sq.  
Hole 1"  
Wt. 0.8 lbs.

**Art. 819/1**  
Mtl 2 3/8" sq.  
Hole 1 3/16" sq.  
Wt. 0.6 lbs.



**Art. 1408/5**  
Mtl 1 9/16" dia.  
Hole 1/2" dia.  
H 19/32"  
Wt. 0.1 lbs.



**Art. 1408/6**  
Mtl 2 3/8" dia.  
Hole 1 1/4" dia.  
H 11/16"  
Wt. 0.2 lbs.

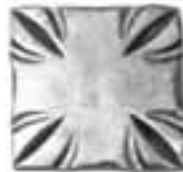

**Art. 94/A/3**  
3 15/16" x 3 15/16"  
5/16" Thickn.  
Wt. 0.8 lbs.

**Art. SHOE 94/A/6/5**  
Mtl 1/4"  
2" sq.  
Hole 9/16" sq.  
Wt. 0.7 lbs.

**Art. 819/8 (SHOE 12)**  
Mtl 1 1/2" sq.  
Hole 1/2" sq.  
Wt. 0.2 lbs.

**Art. 819/6 (SHOE 58)**  
Mtl 1 1/2" sq.  
Hole 5/8" sq.  
Wt. 0.2 lbs.



**Art. 113/9**  
3" dia.  
Wt. 4.6 lbs.



**Art. 113/10**  
2 3/4" dia.  
Wt. 4.9 lbs.



**Art. 94/A/5**  
Mtl 3 5/32" x 3 5/32"  
5/16" Thickn.  
Wt. 0.8 lbs.



**Art. 94/A/4**  
3 5/32" x 3 5/32"  
5/16" Thickn.  
Wt. 0.8 lbs.

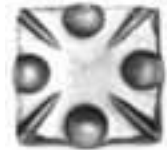

**Art. 94/A/6**  
Mtl 3 5/32" x 3 5/32"  
5/16" Thickn.  
Wt. 0.8 lbs.



**Art. 160/43**  
3 5/32" x 5 1/8"  
Base 1 9/16" dia.  
threaded hole 12 MA  
Wt. 1.5 lbs.



**Art. 160/44**  
3 3/4" x 2 7/8"  
Base 1 9/16" dia.  
threaded hole 12 MA  
Wt. 1.3 lbs.



hot stamped steel

**Art. 1404/1**  
Mtl 4 5/16" dia.  
5 1/2" x 3 17/32"  
Wt. 14.5 lbs.

**Art. 1404/2**  
Mtl 3 17/32" dia.  
4 29/32" x 2 3/4"  
Wt. 8.4 lbs.

**Art. 1404/3**  
Mtl 2 3/4" dia.  
5 15/16" x 2 5/32"  
Wt. 4.0 lbs.

**Art. 1404/4**  
Mtl 2 5/32" dia.  
3 11/32" x 1 3/4"  
Wt. 1.8 lbs.



**Art. 160/45**  
2 9/32" x 4 5/8"  
Base 1 9/16"  
threaded hole 12 MA  
Wt. 1.0 lbs.



**Art. 160/46**  
2 1/8" x 3 1/16"  
Base 1 9/16"  
threaded hole 12 MA  
Wt. 0.7 lbs.

COLUMN TERMINALS



**Art. 128/29**  
2" dia.  
4 1/8"  
Wt. 1.3 lbs.



**Art. 128/30**  
2" dia.  
3 15/16" H  
Wt. 1.9 lbs.



**Art. 128/31**  
3 15/16" H  
7 3/32" H  
Wt. 12.8 lbs.

**Art. 128/32**  
3 15/16" dia.  
7 7/8"  
Wt. 12.8 lbs.

**Art. 128/33**  
1 3/32" dia.  
3 5/32" H  
Wt. 0.9 lbs.

**Art. 128/35**  
2" H  
3 17/32" H  
Wt. 1.7 lbs.

**Art. 128/34**  
3 15/16" dia.  
7 7/8" H  
Wt. 12.8 lbs.



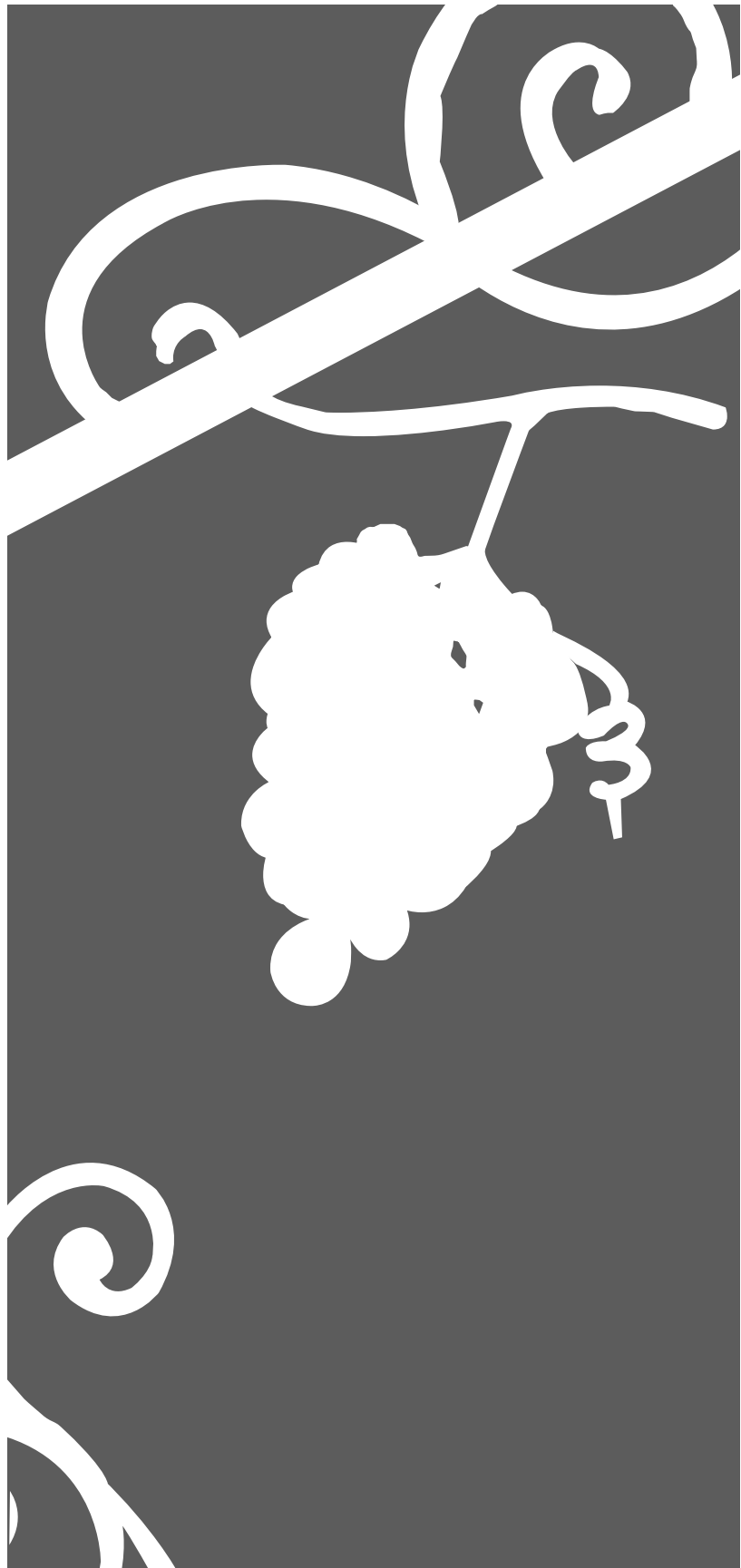

FLOWERS AND ORNAMENTS Quick Reference # 7 2011





**Art. 1406/9**  
Mtl 13/16"  
3 15/16" dia.  
Wt. .18 lbs.



**Art. 1406/7**  
Mtl 1"  
3 9/16" dia.  
Wt. .15 lbs.



**Art. 1406/3**  
Mtl 1 9/16"  
5 1/2" dia.  
Wt. .15 lbs.

**CAST IRON**



**Art. 756/12**  
Mtl 5 5/16" dia.  
Thread hole M5  
Thickn. 1/2"  
Wt. 1.7 lbs.



**Art. 756/2**  
Mtl 3 5/32" dia.  
Thread hole M5  
Wt. .47 lbs.



**Art. 1393/8**  
Mtl 3 9/16" dia.  
Thread hole M5  
Thickn. 5/16"  
Wt. .48 lbs.



**Art. 756/4**  
Mtl 3 15/16" dia.  
Thread hole M6  
Wt. .79 lbs.

**Art. 756/12**  
Mtl 4 17/32" dia.  
Thread hole M5  
Thickn. 1/2"  
Wt. 1.7 lbs.

**Art. 756/14**  
Mtl 3 15/16" dia.  
Thread hole M5  
Thickn. 3/8"  
Wt. 1.7 lbs.





**Art 1331/2**  
W 17 23/32"  
H 17 23/32"  
Wt. 5.3 lbs.  
**Art. 1331/4**  
Unpainted



































**Art. 1329/1**  
Mtl. 5/16" dia.  
W 5 1/2"  
H 17 3/4"  
Wt. 1.0 lbs.



**Art. 1329/6**  
Mtl. 5/16" dia.  
W 5 1/8"  
H 19 11/16"  
Wt. 1.5 lbs.

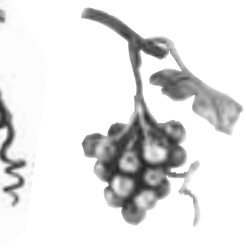
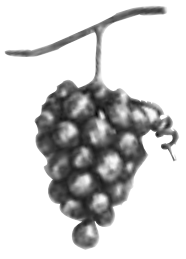

# High Quality Hand Forged Leaves

								
Art. 689/7	Art. 689/8	Art. 689/9	Art. 689/10	Art. 691/1	Art. 691/2	Art. 691/3	Art. 691/4	Art. 691/5
Mtl 1/2" dia.	Mtl 1/2" dia.	Mtl 1/2" dia.	Mtl 1/2" dia.	Mtl 1/2" dia.	Mtl 1/2" dia.	W 2 3/4"	W 2 3/4"	Mtl 1/2" dia.
W 6 5/16"	W 6 5/16"	W 7 7/8"	W 7 7/8"	W 6 5/16"	W 6 5/16"	H 4 3/4"	H 4 3/4" 3/16"	2 15/16" dia.
H 3 15/16"	H 3 15/16"	H 5 7/8"	H 5 7/8"	H 3 15/16"	H 3 15/16"	3/16" thickn.	thickn.	Wt. 0.4 lbs.
3/16" thickn.	3/16" thickn.	3/16" thickn.	3/16" thickn.	3/16" thickn.	3/16" thickn.	Wt. 0.2 lbs.	Wt. 0.2 lbs.	
Wt. 0.7 lbs.	Wt. 0.7 lbs.	Wt. 1.0 lbs.	Wt. 1.0 lbs.	Wt. 0.5 lbs.	Wt. 0.5 lbs.			
								
Art. 692/1	Art. 691/6	Art. 691/7	Art. 692/2	Art. 692/3	Art. 692/4	Art. 692/6	Art. 694/12	Art. 694/13
W Mtl 3 11/32"	Mtl 1/2" dia.	Mtl 1/2" dia.	W 3 1/8"	W 2 3/8"	W 3 3/4"	W 3 1/8"	W 4 3/4"	W 4 3/4"
H 10 5/8"	W 3 1/8"	W 3 1/8"	H 3 1/8"	H 3 3/4"	H 6 5/8"	H 6 5/16"	H 8 1/4"	H 8 1/4"
5/32" thickn.	H 3 15/16"	H 3 15/16"	5/32" thickn.	5/32" thickn.	3/16" thickn.	3/16" thickn.	1/4" thickn.	1/4" thickn.
Wt. 0.7 lbs.	3/16" thickn.	3/16" thickn.	Wt. 0.4 lbs.	Wt. 0.2 lbs.	Wt. 0.6 lbs.	Wt. 0.3 lbs.	Wt. 0.8 lbs.	Wt. 0.8 lbs.
	Wt. 0.2 lbs.	Wt. 0.2 lbs.						
								
Art. 692/8	Art. 692/9	Art. 692/10	Art. 94/B/3	Art. 94/B/4	Art. 94/B/9	Art. 94/B/10	Art. 94/B/11	Art. 94/B/12
W 4 5/16"	W 2"	W 4 5/16"	W 4 1/2"	W 3 1/8"	W 3 11/32"	W 3 11/32"	W 5 1/8"	W 5 1/8"
H 13"	H 7 1/16"	H 9 1/16"	H 8 5/8"	H 9 7/8"	H 4 3/4"	H 4 3/4"	H 7 1/16"	H 7 1/16"
5/32" thickn.	5/32" thickn.	5/32" thickn.	5/32" thickn.	5/32" thickn.	5/32" thickn.	5/32" thickn.	5/32" thickn.	5/32" thickn.
Wt. 2.1 lbs.	Wt. 0.6 lbs.	Wt. 0.9 lbs.	Wt. 0.6 lbs.	Wt. 0.5 lbs.	Wt. 0.3 lbs.	Wt. 0.3 lbs.	Wt. 0.6 lbs.	Wt. 0.6 lbs.
								
Hand forged	Hand forged	Hand forged	Hand forged	Art. 673/3	Art. 140/H/3	Art. 140/H/4		
Art. 140/H/1	Art. 140/H/2	Art. 673/1	Art. 673/2	Mtl. 1/4" dia.	Mtl 3/16"	Mtl 3/16"		
W 5 1/8"	W 3 9/16"	W 5 1/8"	W 3 9/16"	H 5 7/8"	3 9/16" x 4 15/16"	5 7/8" x 7 5/8"		
H 10 5/8"	H 6 5/8"	H 10 5/8"	H 6 5/8"	Wt. 0.2 lbs.	Wt. 0.4 lbs.	Wt. 0.9 lbs.		
Wt. 8.6 lbs.	Wt. 2.5 lbs.	Wt. 7.7 lbs.	Wt. 2.4 lbs.					

STAMPED LEAVES



Art. 136/1  
Mtl 1/8"  
W 1 9/16"  
H 5 5/16"  
right hand  
Wt. 0.2 lbs.



Art. 136/2  
Mtl 1/8"  
W 1 9/16"  
H 5 5/16"  
left hand  
Wt. 0.2 lbs.



Art. 136/10  
Mtl 1/8"  
W 2 3/4"  
H 6 5/16"  
right hand  
Wt. 0.3 lbs.



Art. 136/11  
Mtl 1/8"  
W 2 3/4"  
H 6 5/16"  
left hand  
Wt. 0.3 lbs.



Art. 136/4  
Mtl 1/8"  
W 2 3/4"  
H 2 3/8"  
right hand  
Wt. 0.2 lbs.



Art. 136/3  
Mtl 1/8"  
W 2 3/4"  
H 2 3/8"  
left hand  
Wt. 0.2 lbs.

SOLID BRASS



Art. 1463/14  
Mtl 1/8"  
W 2 3/4"  
H 2 3/8"  
right hand  
Wt. 0.2 lbs.



Art. 1463/15  
Mtl 1/8"  
W 2 3/4"  
H 2 3/8"  
left hand  
Wt. 0.2 lbs.

FULLY WELDABLE CAST STEEL LEAVES



Art. 661/1  
Mtl 5/8" x 5/16"  
W 5 1/2"  
H 6 1/8"  
Wt. 0.6 lbs.



Art. 661/2  
Mtl 5/8" x 5/16"  
W 5 1/2"  
H 6 1/8"  
Wt. 0.6 lbs.



Art. 661/3  
Mtl 5/16" dia.  
W 4 5/16"  
H 6 1/8"  
Wt. 0.8 lbs.



Art. 661/4  
Mtl 5/16" dia.  
W 3"  
H 4 15/16"  
Wt. 0.3 lbs.



Art. 663/1  
Mtl 5/8" x 1/4"  
W 4 5/16"  
H 5 1/2"  
Wt. 0.4 lbs.



Art. 663/2  
Mtl 5/8" x 1/4"  
W 4 5/16"  
H 5 1/2"  
Wt. 0.4 lbs.



Art. 1463/17  
Mtl 1/8"  
W 4 5/16"  
H 1 9/16"  
right hand  
Wt. 0.2 lbs.



Art. 1463/18  
Mtl 1/8"  
W 4 5/16"  
H 1 9/16"  
left hand  
Wt. 0.2 lbs.



Art. 663/5  
Mtl 1/2" dia.  
W 4 1/2"  
H 7 1/16"  
Wt. 0.6 lbs.



Art. 663/6  
Mtl 1/2" dia.  
W 4 1/2"  
H 7 1/16"  
Wt. 0.6 lbs.



Art. 663/7  
Mtl 1/2" dia.  
W 6 5/16"  
H 7 1/2"  
Wt. 0.9 lbs.



Art. 663/8  
Mtl 1/2" dia.  
W 6 5/16"  
H 7 1/2"  
Wt. 0.9 lbs.



Art. 662/3  
Mtl 1/2" dia.  
W 2 9/16"  
H 5 1/8"  
Wt. 0.3 lbs.



Art. 662/4  
Mtl 1/2" dia.  
W 2 9/16"  
H 5 1/8"  
Wt. 0.3 lbs.



Art. 663/3  
Mtl 1/2" dia.  
W 2 3/4"  
H 3 9/16"  
Wt. 0.3 lbs.



Art. 663/4  
Mtl 1/2" dia.  
W 2 3/4"  
H 3 9/16"  
Wt. 0.3 lbs.

Floral Elements



Art. 94/B/5  
4 5/32" dia.  
Mtl 5/32"  
Wt. 0.4 lbs.



Art. 94/B/6  
4 17/32" dia.  
Mtl 5/32"  
Wt. 0.4 lbs.



Art. 695/1  
W 3 1/8"  
H 3 1/8"  
Mtl 5/32"  
Wt. 0.3 lbs.



Art. 695/2  
W 3 11/32"  
H 3 11/32"  
Mtl 5/32"  
Wt. 0.3 lbs.



Art. 695/3  
W 4 5/16"  
H 4 5/16"  
Mtl 5/32"  
Wt. 0.3 lbs.



Art. 695/4  
W 2 3/8"  
H 2 3/8"  
Mtl 5/32"  
Wt. 0.2 lbs.



Art. 695/5  
W 2 3/8"  
H 2 3/8"  
Mtl 5/32"  
Wt. 0.1 lbs.



Art. 696/2  
Mtl 17 5/16" dia.  
Wt. 3.8 lbs.





















Art. 696/3  
Mtl 5/32" dia.  
W 15 3/4"  
H 16 15/16"  
Wt. 6.6 lbs.





















Art. 140/I/3  
Mtl 5/32" dia.  
2 3/8"  
Wt. .9 lbs.

## Flowers in Pressed Sheet Metal









								
<b>Art. 138/3</b> Mtl 5/64" 3 15/32" dia. H 21/32" Wt. 0.1 lbs.	<b>Art. 138/4</b> Mtl 5/64" 3 9/16" dia. H 3/8" Wt. 0.1 lbs.	<b>Art. 138/10</b> Mtl .0197" W 1 3/4" H 3 11/32" Wt. .03 lbs.	<b>Art. 138/11</b> Mtl .0197" W 2 15/16" H 2 3/4" Wt. .03 lbs.	<b>Art. 138/12</b> Mtl .0197" W 3 3/4" H 4 1/8" Wt. .03 lbs.	<b>Art. 138/13</b> Mtl .0197" W 7 1/2" H 7 5/8" Wt. .07 lbs.	<b>Art. 702/1</b> Mtl .0197" W 2 7/16" H 4 5/16" Wt. .04 lbs.	<b>Art. 702/2</b> Mtl .0197" W 2 1/16" H 2 9/16" Wt. .01 lbs.	<b>Art. 702/3</b> Mtl .0197" W 3 1/8" H 7 7/8" Wt. 0.1 lbs.

								
<b>Art. 604/11</b> thickness 5/64" W 1 1/4" H 1 3/4" Wt. .04 lbs.	<b>Art. 604/12</b> W 1 1/4" H 1 3/4" stem 1/8" Wt. .05 lbs.	<b>Art. 140/6</b> Mtl .0118" 11/16" dia. H 19/32" Wt. .01 lbs.	<b>Art. 140/7</b> Mtl .0118" 11/16" dia. H 1/2" Wt. .01 lbs.	<b>Art. 140/8</b> Mtl .0118" 1 17/32" dia. H 3/8" Wt. .01 lbs.	<b>Art. 139/1</b> Mtl .0197" W 1 5/32" H 2 9/16" Wt. .03 lbs.	<b>Art. 139/2</b> Mtl .0197" W 1 39/64" H 3 9/16" Wt. .03 lbs.	<b>Art. 139/3</b> Mtl .0118" W 1 3/16" H 3 11/32" Wt. .04 lbs.	<b>Art. 139/4</b> Mtl .0118" W 2 23/64" H 7 7/8" Wt. .07 lbs.

								
<b>Art. 139/5</b> Mtl .0118" W 1 3/8" H 3 15/16" Wt. 04 lbs.	<b>Art. 139/6</b> Mtl 5/64" W 1 3/32" H 2 3/4" Wt. 03 lbs.	<b>Art. 138/16</b> Mtl .0118" W 1 3/16" H 3 11/32" Wt. .02 lbs.	<b>Art. 138/7</b> Mtl .0118" W 1 3/16" H 3 11/32" Wt. .02 lbs.	<b>Art. 140/1</b> Mtl .0197" W 1" H 2 1/8" Wt. .01 lbs.	<b>Art. 140/2</b> Mtl .0118" W 1 5/32" H 2 7/16" Wt. .02 lbs.	<b>Art. 140/3</b> Mtl .0118" W 1 29/64" H 3 1/8" Wt. .03 lbs.	<b>Art. 140/4</b> Mtl .0118" W 1 3/8" H 3 15/16" Wt. .02 lbs.	<b>Art. 140/5</b> Mtl .0197" W 2 3/8" H 2 23/32" Wt. .2 lbs.

								
<b>Art. 136/5</b> Mtl .0197" 2 9/16" dia. H 1 3/16" Wt. .05 lbs.	<b>Art. 136/6</b> Mtl .0197" 2 1/8" dia. H 1 19/64" Wt. .07 lbs.	<b>Art. 136/7</b> Mtl .0197" 1 1/2" dia. H 1 9/16" Wt. .05 lbs.	<b>Art. 136/8</b> Mtl .0118" 1 21/32" dia. H 11/16" Wt. .02 lbs.	<b>Art. 136/9</b> Mtl .0118" 1 7/8" dia. H 19/32" Wt. .01 lbs.	<b>Art. 137/7</b> Mtl .0197" W 2 3/8" H 5 1/8" Wt. .08 lbs.	<b>Art. 137/8</b> Mtl .0197" W 2" H 3 9/16" Wt. .03 lbs.	<b>Art. 137/9</b> Mtl .0197" W 4 5/16" H 2 9/16" Wt. .04 lbs.	<b>Art. 137/10</b> Mtl .0197" W 6 7/8" H 4 15/16" Wt. 0.1 lbs.

## Heavy Gauge Floral Elements

								
<b>Art. 116/35</b> 2 9/16" dia. H 5/16" hole 19/32" dia. Wt. 0.3 lbs.	<b>Art. 116/A/3</b> 3 3/4" dia. Mtl 1/8" Wt. 0.4 lbs.	<b>Art. 116/A/4</b> 2 5/16" dia. Mtl 1/8" Wt. 0.2 lbs.	<b>Art. 116/A/5</b> 3 3/4" dia. Mtl 1/8" Wt. 0.6 lbs.	<b>Art. 138/2</b> 2 3/8" dia. Mtl 5/64" Wt. 0.1 lbs.	<b>Art. 138/15</b> 2 3/8" dia. Mtl 5/64" Wt. 0.2 lbs.	<b>Art. 126/3</b> 3 1/8" dia. 5/32" thickn. Wt. 0.3 lbs.	<b>Art. 697/3</b> 3 3/4" dia. Mtl 1/8" Wt. 0.5 lbs.	<b>Art. 697/4</b> 2 9/16" dia. Mtl 1/8" Wt. 0.2 lbs.



**ACCESSORIES** Quick Reference # 7 2011



# New Items



**Art. 839/1**  
 1 1/4" dia. (handle)  
 H 11 13/16"  
 Rosette - 3 11/32"  
 Wt. 0.3 lbs.



**Art. 168/1**  
 W 2 23/64"  
 H 11 13/16"  
 Wt. 0.3 lbs.



**Art. 1474/2**  
 3 9/16" dia.  
 bases  
 H 13 3/8"  
 Wt. 0.3 lbs.



**Art. 839/3**  
 Mtl 11/16"  
 W 3 1/8"  
 H 18 7/8"  
 Wt. 0.3 lbs.

## Door Studs



two points

**Art. 171/40**  
 Mtl 5/8"

Wt. 0.3 lbs.

**Art. 171/41**  
 Mtl 3/4"

Wt. 0.3 lbs.

**Art. 171/42**  
 Mtl 1" sq.

Wt. 0.3 lbs.



one point

**Art. 171/37**  
 Mtl 1/2"

Wt. 0.3 lbs.

**Art. 171/38**  
 Mtl 19/32"

Wt. 0.3 lbs.

**Art. 171/39**  
 Mtl 3/4"

Wt. 0.3 lbs.



**Art. 170/6**  
 W 2 3/8"  
 H 12 7/32"  
 Wt. 0.3 lbs.



**Art. 1474/3**  
 W 1 19/32"  
 H 12 13/32"  
 Wt. 0.3 lbs.



**Art. 1474/1**  
 W 2 3/16"  
 H 10 5/8"  
 Wt. 0.3 lbs.



**Art. 1813/1**  
(ex 9170/7)  
Mtl 9/18" x 1/4"  
29 1/2" x 6 1/8"  
Wt. 6.2 lbs.

**Art. 1813/2**  
(ex 9160/8)  
Mtl 9 7/8" x 5 7/8"  
Wt. 1.5 lbs.



Not double faced



GLASS

**Art. 478/3**  
3 1/2" dia.  
Wt. 0.4 lbs.



WOOD

**Art. 745/1**  
3 7/8" dia.  
Wt. 0.4 lbs.



BRASS

**Art. 160/H/N**  
3 7/8" dia.  
Wt. 0.4 lbs.

Brass, glass and wooden embellishments are suggested for inside use only.

Self Taping Screws



**Art. 695/6**  
Mtl 1 3/16"  
3 17/32" x 3/8"  
Wt. 0.3 lbs.



**Art. 695/7**  
Mtl 27/32"  
2 15/16" x 5/16"  
Wt. 0.1 lbs.



**Art. 695/8**  
Mtl 5/8"  
2 7/16" x 5/16"  
Wt. 0.1 lbs.



**Art. 695/9**  
Mtl 1 1/4"  
3 17/32" x 5/8"  
Wt. 0.4 lbs.



**Art. 695/10**  
Mtl 15/16"  
3 11/32" x 5/16"  
Wt. 0.1 lbs.



**Art. 695/11**  
Mtl 3/4"  
2 7/16" x 5/16"  
Wt. 0.1 lbs.

Rivets

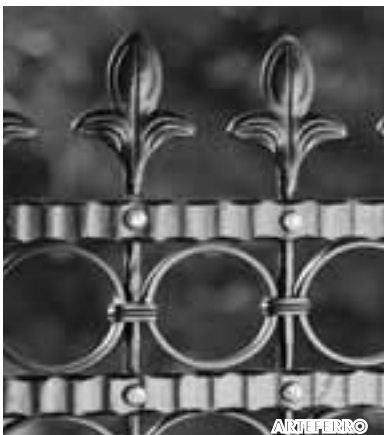

**Art. 695/12**  
Mtl 1/2"  
2 15/16" x 7/32"  
Wt. 0.03 lbs.



**Art. 41/1**  
Mtl 5/16" x 1"  
Wt. 0.03 lbs.  
**Art. 41/14**  
Mtl 5/16" x 5/16"  
Wt. 0.02 lbs.

**Art. 41/15**  
Mtl 5/16" x 3/4"  
Wt. 0.03 lbs.  
**Art. 41/18**  
Mtl 5/16" x 1"  
Wt. 0.2 lbs.  
**Art. 41/21**  
Mtl 1/4" x 19/16"  
Wt. 0.02 lbs.



**Art. 41/9**  
Mtl 5/16" x 19/16"  
5/8"  
Wt. 0.05 lbs.  
**Art. 41/10**  
Mtl 1/4" x 19/16"  
1/2"  
Wt. 0.02 lbs.



**Art. 41/11**  
Mtl 5/16" x 1"  
21/32"  
Wt. 0.04 lbs.  
**Art. 41/12**  
Mtl 5/16" x 1 3/16"  
21/32"  
Wt. 0.04 lbs.

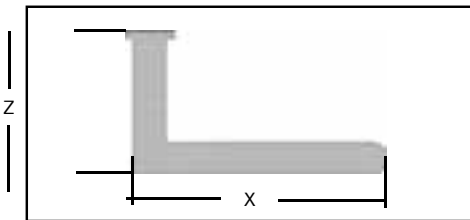
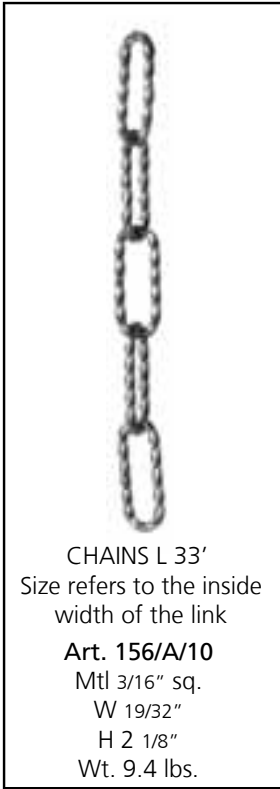

Door handles (Galvanized and Painted)



Rosettes for handles

ALL OF THESE ITEMS ARE SUPPLIED IN PAIR

Rosettes for locks



Art. 1476/9  
Wt. 0.3 lbs.



Art. 1476/11  
Wt. 0.2 lbs.



Art. 1476/13  
Wt. 0.2 lbs.



Art. 1476/10  
Wt. 0.3 lbs.



Art. 1476/12  
Wt. 0.2 lbs.



Art. 1476/14  
Wt. 0.2 lbs.

Hinges, Pulls and Lockets



Art. 169/11  
W 4 15/16"  
H 2 3/4"  
Wt. 0.6 lbs.



Art. 169/15  
W 4 15/16"  
H 1 9/16"  
Wt. 0.6 lbs.



Art. 170/A/2  
W 4 15/16"  
H 2 5/8"  
Wt. 0.1 lbs.



Art. 170/B/4  
Mtl 9/16" dia.  
W 2 1/16"  
H 3 5/16"  
Wt. 0.3 lbs.



Art. 170/B/5  
W 3 5/8"  
H 3 3/16"  
Wt. 0.2 lbs.



Art. 170/A/3  
W 2 1/8"  
H 3 5/8"  
Wt. 0.1 lbs.



Art. 170/A/5  
W 1 11/16"  
H 1 5/16"  
Wt. 0.1 lbs.



Art. 170/A/7  
W 1 7/8"  
H 1 7/8"  
Wt. 0.1 lbs.



Art. 170/5  
2" dia.  
Wt. .07 lbs.



Art. 181/10  
Mtl 1 3/16" dia.  
W 4 1/8"  
H 11 1/4"  
1 3/16" thick.  
Wt. 4.6 lbs.

Art. 181/11  
Mtl 1 3/16" dia.  
W 4 1/8"  
H 11 1/4"  
1 3/16" thick.  
Wt. 4.6 lbs.

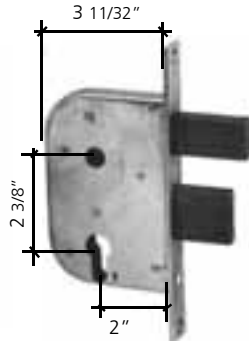

Art. 181/12  
W 4 1/8"  
H 11 1/4"  
Wt. 1.8 lbs.



Art. 181/13  
Threaded  
22 MA  
H 9 1/16"  
Wt. 4.1 lbs.



Art. 181/14  
Threaded  
17 MA  
H 6 7/8"  
Wt. 2.1 lbs.



Art. 181/15  
Threaded for  
Art. 181/11  
Art. 181/12  
Wt. 0.4 lbs.

## HINGES CERTIFIED FOR HIGH CAPACITY



**Art. 181/13**  
Threaded  
22 MA  
9 1/16" H  
Wt. 4.1 lbs.



**Art. 181/14**  
Threaded  
17 MA  
6 7/8" H  
Wt. 2.1 lbs.



PIVOT

with HINGE  
18MA  
**art. 164/7**  
to be coupled with  
**art. 164/9**

with HINGE  
18MA  
**art. 164/8**  
to be coupled with  
**art. 164/10**



PLATE

with HINGE  
18MA  
**Art. 164/9**

with HINGE  
22MA  
**Art. 164/10**

**CERTIFIED PRODUCTS**  
CERTIFICATION AN TESTED AVAILABLE AT  
[WWW.ARTEFERRO.COM](http://WWW.ARTEFERRO.COM)





Decorative Aluminum Rosettes and Panels

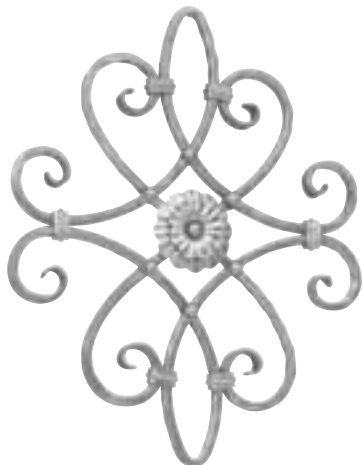

**Art. 26/C/1/ALL**  
Mtl. 9/16" sq.  
W 17" x H 20 1/2"  
Plain square bar  
Floral element on  
one side only  
Wt. 3.3 lbs.

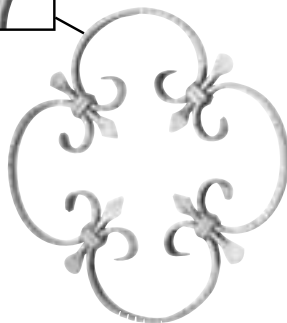

**Art. 1867/1**  
13" dia.  
Mtl 1/2" x 1/4"  
Wt. 0.95 lbs.  
Hammered



**Art. 1867/3**  
10 1/4" dia.  
Mtl 1/2" x 1/4"  
Wt. 0.8 lbs.



**Art. 1867/2**  
(ex 454/2/S)  
Mtl 1/2" x 1/4"  
9 7/8" dia.  
Wt. 0.77 lbs.

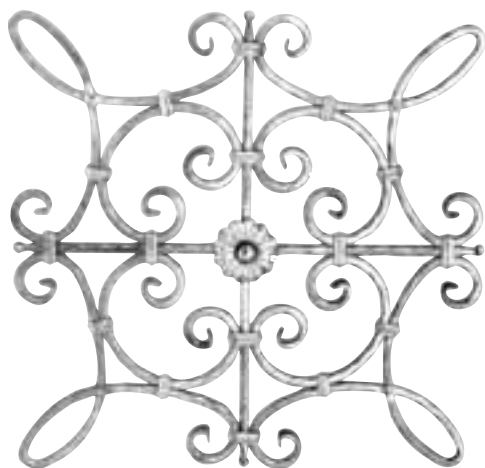

**Art. 480/1/S/ALL**  
Hammered  
Mtl. 9/16" sq.  
W 26" x H 26"  
Wt. 7.48 lbs.

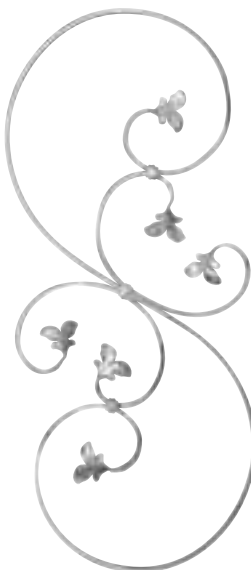

**Art. 767/1**  
Mtl 1/2" x 1/4"  
W 13 3/4"  
H 34 1/4"  
Wt. 1.8 lbs.

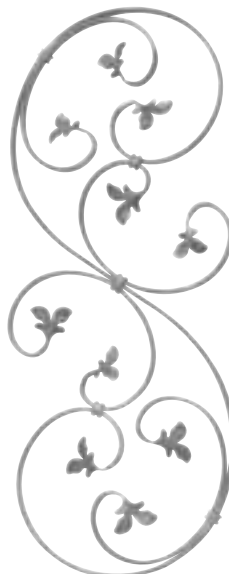

**Art. 1671/3/ALL**  
Mtl 1/2" x 1/4"  
W 13 3/4"  
H 34 1/4"  
Wt. 2.5 lbs.

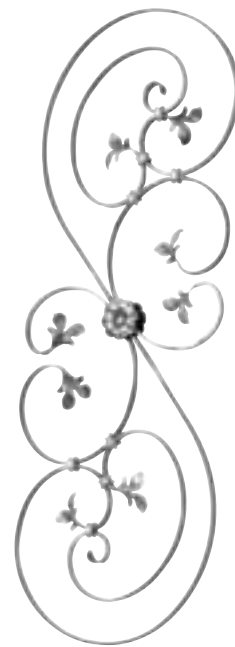

**Art. 1670/1/ALL**  
Mtl 1/2" x 1/4"  
W 14 3/16"  
H 39 1/2"  
Wt. 2.78 lbs.



**Art. 1435/1**  
Mtl 3/4" x 1/4"  
W 51 9/16"  
H 16 17/32"  
Wt. 5.1 lbs.

**Art. 1435/2**  
Mtl 3/4" x 1/4"  
W 43 5/16"  
H 16 17/32"  
Wt. 4.7 lbs.



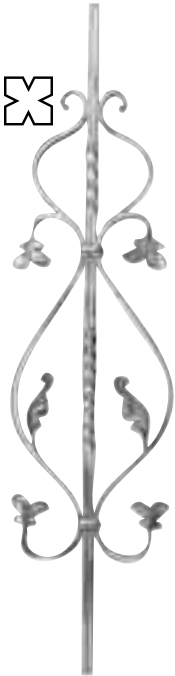

**Art. 769/1**  
Mtl 9/16" sq.  
W 9 1/4"  
H 39 1/2"  
Wt. 2.3 lbs.  
Grooved



**Art. 769/2**  
Mtl 9/16" sq.  
H 39 1/2"  
Wt. 1.1 lbs.  
Grooved



**Art. 769/13**  
Mtl 9/16" sq.  
H 39 1/2"  
Wt. 1.1 lbs.  
Grooved

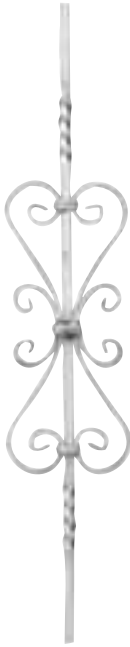

**Art. 769/5**  
Mtl 9/16" sq.  
W 7 1/16"  
H 39 1/2"  
Wt. 2.2 lbs.



**Art. 769/7**  
Mtl 9/16" sq.  
H 39 1/2"  
Wt. 1.1 lbs.



**Art. 769/8**  
Mtl 9/16" sq.  
H 39 1/2"  
Wt. 1.1 lbs.

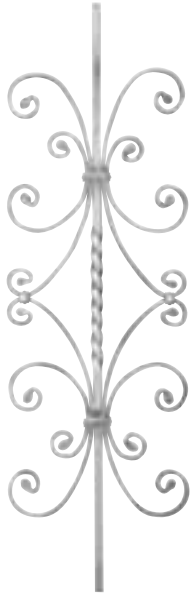

**Art. 769/6**  
Mtl 9/16" sq.  
W 11 13/16"  
H 35 7/16"  
Wt. 3.3 lbs.



**Art. 1869/10**  
(ex 769/13/S)  
Mtl 9/16" sq.  
H 39 1/2"  
Wt. 1.1 lbs  
Plain



**Art. 1869/8**  
Mtl. 9/16" sq.  
H 39 1/2"  
Wt. 1.1 lbs.  
Grooved



**Art. 1869/9**  
Mtl. 9/16" sq.  
H 39 1/2"  
Wt. 1.1 lbs.  
Grooved



**Art. 1090/3/ALL**  
Mtl 1/2" sq.  
W 3 9/16"  
H 39 1/2"  
Wt. 1.0 lbs.



**Art. GD58/3/ALL**  
Mtl 1/2" sq.  
W 4 3/4"  
H 39 1/2"  
Wt. 1.1 lbs.



**Art. GD59/2/ALL**  
Mtl 1/2" sq.  
W 2 3/4"  
H 39 1/2"  
Wt. 1.0 lbs



**Art. 134/10/ALL**  
Mtl 1/2" sq.  
H 39 1/2"  
Wt. 1.0 lbs.



**Art. 134/2/ALL**  
Mtl 1/2" sq.  
H 39 1/2"  
Wt. 1.0 lbs.

# Decorative Aluminum Balusters

Newel post



**Art. 768/10**  
Mtl 1" sq.  
H 47 1/4"  
Wt. 4.4 lbs.



**Art. 768/4**  
Mtl 9/16"sq.  
H 39 1/2"  
Wt. 1.0 lbs.



**Art. 768/5**  
Mtl 9/16" sq.  
H 39 1/2"  
Wt. 1.0 lbs.



**Art. 768/6**  
Mtl 9/16"sq.  
W 1 3/16"  
H 39 1/2"  
Wt. 1.1 lbs.



**Art. 1444/14**  
Mtl 5/8" sq.  
39 1/2" H  
Wt. 1.5 lbs.



**Art. 1444/15**  
Mtl 5/8" sq.  
39 1/2" H  
Wt. 1.5 lbs.



**Art. 1444/16**  
Mtl 5/8" sq.  
W 7 7/8"  
H 39 1/2"  
Wt. 2.0 lbs.



**Art. 1444/17**  
Mtl 5/8" sq.  
W 5 1/2"  
H 39 1/2"  
Wt. 1.6 lbs.



**Art. 768/1**  
Mtl 1/2" x 1/4"  
W 2 3/8"  
H 4 1/8"  
Wt. 0.1 lbs.



**Art. 768/2**  
Mtl 1/2" x 1/4"  
W 2 3/8"  
H 4 1/8"  
Wt. 0.1 lbs.



**Art. 770/15**  
Mtl 1/2" x 1/4"  
W 4 1/8"  
H 5 7/8"  
Wt. 0.18 lbs.



**Art. 768/7**  
Mtl 9/16"sq.  
W 4 5/16"  
H 39 1/2"  
Wt. 1.5 lbs.



**Art. 768/8**  
Mtl 9/16"sq.  
W 8 7/8"  
H 39 1/2"  
Wt. 1.8 lbs.

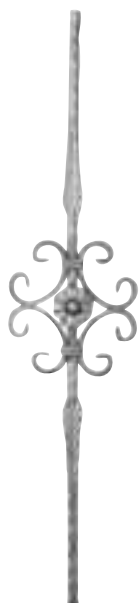

**Art. 768/9**  
Mtl 9/16"sq.  
W 8 1/4"  
H 39 1/2"  
Wt. 1.6 lbs.



**Art. 768/3**  
Mtl 9/16"sq.  
W 5 1/2"  
H 39 1/2"  
Wt. 1.2 lbs.



**Art. 64/1/4/S/AL**  
Mtl. 9/16" sq.  
H 39 1/2"  
Wt. 1.43 lbs.



**Art. 1869/6**  
(ex 64/1/3/AL)  
Mtl. 9/16" sq.  
H 39 1/2"  
Wt. 1.1 lbs.



**Art. 1869/7**  
(ex 64/1/2/AL)  
Mtl. 9/16" sq.  
H 39 1/2"  
Wt. 1.3 lbs.



**Art. 769/9**  
Mtl 9/16" sq.  
W 2 3/16"  
H 39 1/2"  
Wt. 1.3 lbs.



**Art. 769/10**  
Mtl 9/16" sq.  
W 2 3/16"  
H 39 1/2"  
Wt. 1.2 lbs.



**Art. 768/11**  
Mtl 9/16" sq.  
W 3 15/16"  
H 39 1/2"  
Wt. 1.1 lbs.



**Art. 768/12**  
Mtl 9/16" sq.  
H 39 1/2"  
Wt. 1.2 lbs.



Newel post

**Art. 769/11**  
Mtl 1" sq.  
H 47 1/4"  
Wt. 4.7 lbs.



**Art. 772/17**  
Mtl 9/16" x 9/16"  
L 63"  
Wt. 2.2 lbs.  
Grooved

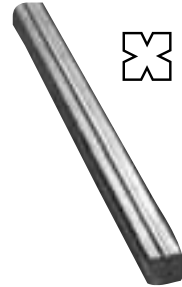

**Art. 772/16**  
Mtl 9/16" x 9/16"  
L 10' Approx.  
Wt. 4.13 lbs.  
Grooved



**Art. 1869/11**  
Mtl 1 9/16" x 15/16"  
Hole 19/32"  
Wt. 0.1 lb.



**Art. 1444/11**  
Mtl 5/8" sq.  
39 1/2" H  
Wt. 1.5 lbs.



**Art. 1444/12**  
Mtl 5/8" sq.  
39 1/2" H  
Wt. 1.5 lbs.



**Art. 1444/13**  
Mtl 5/8" sq.  
39 1/2" H  
Wt. 1.5 lbs.



**Art. 1440/1**  
Mtl 5/8" sq.  
H 39 1/2"  
Wt. 1.5 lbs.



**Art. 1440/2**  
Mtl 5/8" sq.  
H 39 1/2"  
Wt. 1.4 lbs.



**Art. 48/6/ALL**  
Mtl 9/16" sq.  
H 35 7/16"  
Wt. 1.8 lbs.



**Art. 48/7/ALL**  
Mtl 9/16" sq.  
H 35 7/16"  
Wt. 1.5 lbs.

# Decorative Aluminum Balcony Elements



**Art. 769/3**  
Mtl 1 9/16" x 5/16"  
35 7/16" H  
Wt. 2.6 lbs.  
Hammered



**Art. 769/3/S**  
Mtl 1 9/16" x 5/16"  
35 7/16" H  
Wt. 2.6 lbs



**Art. 1444/8**  
Mtl 1 9/16" x 5/16"  
7 7/8" W x 39 1/2" H  
Wt. 2.9 lbs.



**Art. 1702/14/ALL**  
Mtl 9/16" sq.  
39 1/2" H  
Wt. 1.1 lbs.



**Art. 1783/9/ALL**  
Mtl 9/16" sq.  
39 1/2" H  
Wt. 1.43 lbs.

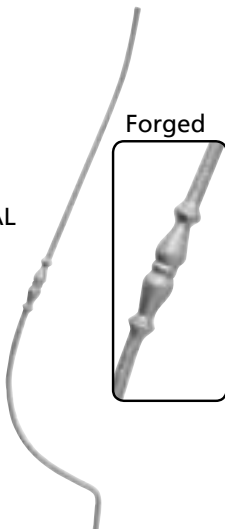

**Art. 1783/3/AL**  
Mtl 1/2" dia.  
39 1/2" H  
Hammered

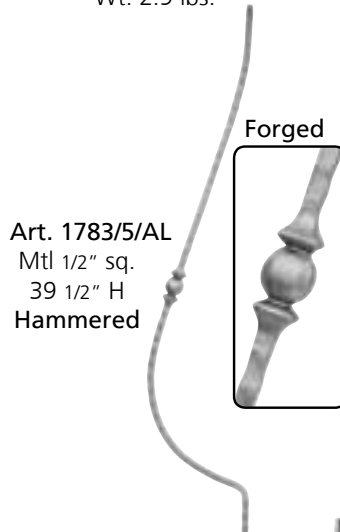

**Art. 1783/5/AL**  
Mtl 1/2" sq.  
39 1/2" H  
Hammered

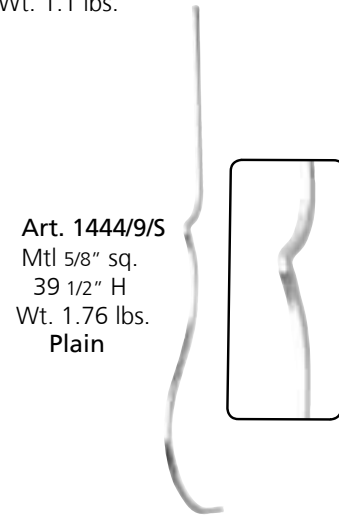

**Art. 1444/9/5**  
Mtl 5/8" sq.  
39 1/2" H  
Wt. 1.76 lbs.  
Plain



**Art. 47/11/AL**  
Mtl 9/16" sq.  
W 2 1/8"  
H 35 7/16"  
Wt. 1.25 lbs.



**Art. 47/11/S/AL**  
Mtl 9/16" sq.  
W 2 1/8"  
H 35 7/16"  
Wt. 1.25 lbs.



**Art. 47/3/ALL**  
Mtl 1/2" sq.  
H 35 7/16"  
Wt. 1.1 lbs.



**Art. 586/7/ALL**  
Mtl 9/16" sq.  
H 39 1/2"  
Wt. 1.0 lbs.



**Art. 769/4**  
Mtl 9/16" sq.  
H 39 1/2"  
Wt. 1.1 lbs.



**Art. 769/12**  
Mtl 9/16" sq.  
H 39 1/2"  
Wt. 1.6 lbs.



**Art. 60/4/ALL**  
Mtl 9/16" sq.  
4 23/32" W x 39 1/2" H



**Art. 49/3/58**  
Mtl 9/16" sq.  
35 7/16" W x 39 1/2" H



**Art. 1051/2/ALL**  
Mtl 1/2" sq.  
5 29/32" W x 39 1/2" H



**Art. 64/A/6/ALL**  
Mtl 9/16" sq.  
10 1/4" W x 35 7/16" H



**Art. 469/1/ALL**  
Mtl 5/16" sq.  
5 45/64" W x 35 7/16" H



**Art. 1435/3**  
Mtl 3/4" x 1/4"  
33" W x 13" H  
Wt. 2.2 lbs.



**Art. 1435/4**  
Mtl 3/4" x 1/4"  
27 9/16" W x 12 13/64" H  
Wt. 1.9 lbs.



**Art. 1435/5**  
Mtl 3/4" x 1/4"  
24 13/32" W x 10 15/64" H  
Wt. 1.6 lb.



**Art. 767/2**  
Mtl 3/4" x 1/4"  
9 1/4" W x 28 3/8" H  
Wt. 1.8 lbs.



**Art. 767/3**  
Mtl 3/4" x 1/4"  
9 1/4" W x 28 3/8" H  
Wt. 1.2 lbs.

Decorative Aluminum Panels



Art. 511/1/ALL  
Mtl 1/2" sq.  
W 4 15/16"  
H 35 7/16"  
Wt. 1.8 lbs.  
Hammered



Art. 1869/5  
(ex 1051/1/ALL)  
Mtl 1/2" sq  
W 7 9/32"  
H 39 1/2"  
Wt. 1.3 lbs



Art. GD61/1/ALL  
Mtl 1/2" sq.  
W 16 7/8"  
H 39 1/2"  
Wt. 8.14 lbs



Art. 1046/1/ALL  
Mtl 1/2" sq.  
W 9 7/8"  
H 35 7/16"  
Wt. 4.6 lbs

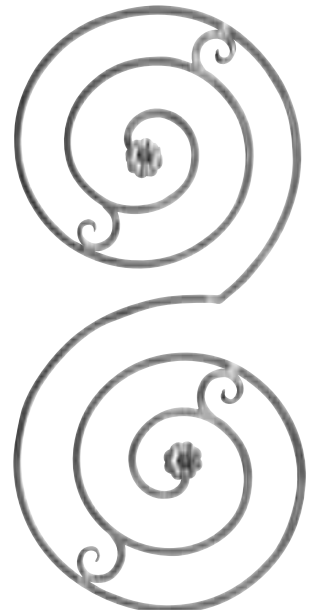

Art. 1038/1/ALL  
Mtl 9/16" sq.  
W 20 5/64"  
H 42 33/64"  
Wt. 7.7 lbs



Art. 1043/1/ALL  
Mtl 1/2" sq.  
W 8 1/4"  
H 40 1/2"  
Wt. 4.0 lbs

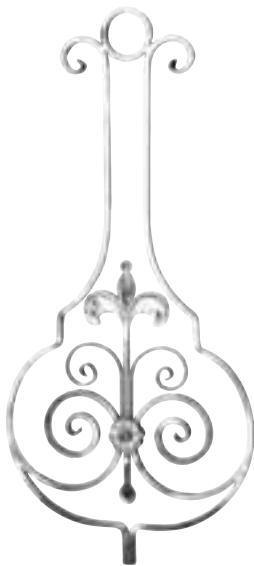

Art. 1043/2/ALL  
Mtl 1/2" sq.  
W 19 5/16"  
H 40 1/2"  
Wt. 7.9 lbs

Snap Ons

These patterns are open at the back to accept and be welded to a 1/2" bar

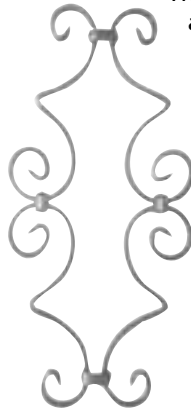

Art. 35/1/ALL  
Mtl 1/2" x 1/4"  
W 8 1/16"  
H 17 1/2"



Art. 35/2/ALL  
Mtl 1/2" x 1/4"  
W 7 7/8"  
H 13 9/16"

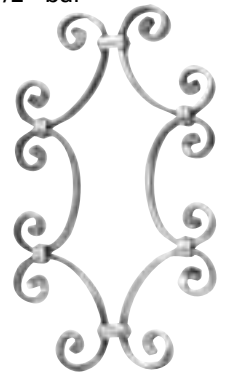

Art. 36/2/ALL  
Mtl 1/2" x 1/4"  
W 9 1/16"  
H 15"

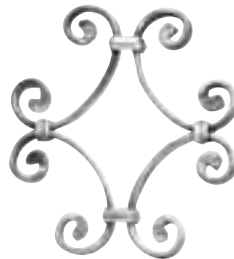

Art. 36/1/ALL  
Mtl 1/2" x 1/4"  
W 8 5/8"  
H 9 7/8"



Art. 37/3/ALL  
Mtl 1/2" x 1/4"  
W 3 3/4"  
H 3 3/4"



**Art. 1869/2**  
9/16" dia.  
W 13 9/16"  
H 35 7/16"  
Wt. 4.0 lbs



**Art. 1869/3**  
(ex 1438/1/S)  
9/16" sq.  
W 14 9/16"  
H 35 7/16"  
Wt. 5.1 lbs



**Art. 1869/4**  
9/16" dia.  
W 13 3/4"  
H 35 7/16"  
Wt. 2.8 lbs



**Art. 1438/2**  
9/16" sq.  
W 15 3/8"  
H 35 7/16"  
Wt. 3.3 lbs.



**Art. 1046/3/ALL**  
Mtl 1/2" sq.  
W 9 7/16"  
H 17 1/8"



**Art. 1046/4/ALL**  
Mtl 1/2" sq.  
W 7 9/32"  
H 12 5/8"



**Art. 1046/5/ALL**  
Mtl 1/2" sq.  
W 7 1/16"  
H 17 1/2"



**Art. 1869/1**  
(ex 541/2/AL)  
Mtl 9/16" dia.  
W 14 9/16"  
H 35 7/16"  
Wt. 4.0 lbs



**Art. 1438/1**  
9/16" sq.  
W 14 9/16"  
H 35 7/16"  
Wt. 5.1 lbs.  
Hammered

**Art. 1046/6/ALL**  
Mtl 1/2" sq.  
W 4 5/16"  
H 6 5/16"



**Art. 1046/7/ALL**  
Mtl 1/2" sq.  
W 2 9/16"  
H 4 1/8"



**Art. 770/11**  
Mtl 1/2" x 1/4"  
W 3 5/32"  
H 18 1/8"  
Wt. 0.1 lb.



**Art. 770/12**  
Mtl 1/2" x 1/4"  
W 5 3/42"  
H 14 1/2"  
Wt. 0.3 lb.



**Art. 80/C/16/ALL**  
Mtl 1/2" x 1/4"  
W 3 1/8"  
H 11 7/16"  
Wt. 0.10 lb.



**Art. 1867/5**  
Mtl 9/16" sq.  
W 6 5/16"  
H 9 1/16"  
Wt. 0.8 lbs.  
Hammered  
**Art. 1867/6**  
Mtl 9/16" dia.  
W 6 5/16"  
H 9 1/16"  
Wt. 0.8 lbs.  
Plain



**Art. 634/4/S/ALL**  
9/16" sq.  
W 6 5/16"  
H 8 7/8"  
Wt. 0.4 lbs.  
Plain



**Art. 634/8/ALL**  
Mtl. 9/16" dia.  
W 6 5/16"  
H 8 7/8"  
Wt. 0.6 lbs.

**Art. 1438/3**  
9/16" sq.  
W 6 5/16"  
H 8 7/8"  
Wt. 0.8 lbs.  
Hammered



# Decorative Forged Aluminum Newels & Balusters



Art. 113/8/AL  
Mtl 1 3/16" sq.  
H 47 1/4"  
Wt. 6.25 lbs.



Art. 1775/12/S1/AL  
Mtl 1 3/16" sq.  
H 47 1/4"  
Wt. 6.25 lbs.



Art. 1448/1  
Mtl 1 3/16" dia.  
H 47"  
Wt. 3.7 lbs.



Art. 1448/2  
Mtl 1 3/16" sq.  
H 47"  
Wt. 5.7 lbs.



Art. 1448/3  
Mtl 1 3/16" sq.  
H 47"  
Wt. 5.7 lbs.



Art. 113/1/25/S/ALL  
Mtl 1" sq.  
H 47 1/4"  
Wt. 4.0 lbs.



Art. 1445/2  
Mtl 9/16" sq.  
H 39 1/2"  
Wt. 1.5 lbs.



Art. 1445/1  
Mtl 9/16" sq.  
H 39 1/2"  
Wt. 1.1 lbs.



Art. 1446/1  
tapered  
H 39 1/2"  
Wt. 1.6 lbs.



Art. 1446/3  
Mtl 1/2" sq.  
H 39 1/2"  
Wt. 1.1 lbs.



Art. 1446/4  
Mtl 1/2" sq.  
H 39 1/2"  
Wt. 1.3 lbs.



Art. 1446/3/S  
Mtl 1/2" sq.  
H 39 1/2"  
Wt. 1.1 lbs.



Art. 1446/5  
Mtl. 1/2" dia.  
H 39 1/2"  
Wt. 0.9 lbs.



Art. 1446/6  
Mtl. 1/2" dia.  
H 39 1/2"  
Wt. 0.8 lbs.



Art. 1446/2  
Mtl 1/2" dia.  
H 39 1/2"  
Wt. 0.76 lbs.



Art. 1445/5  
tapered  
H 39 1/2"  
Wt. 1.43 lbs.

Decorative Aluminum Scrolls



**Art. 1437/18**  
Mtl 3/4" x 1/4"  
W 5 3/4"  
H 8 1/16"  
Wt. 0.1 lb.



**Art. 1437/19**  
Mtl 3/4" x 1/4"  
W 3 1/2"  
H 7 9/32"  
Wt. 0.1 lb.



**Art. 1867/4**  
9/16" sq.  
W 10 1/32"  
H 10 5/8"  
Wt. 1.3 lbs.



**Art. 770/1**  
Mtl 3/4" x 1/4"  
W 6 5/16"  
H 9 7/8"  
Wt. 0.3 lb.



**Art. 770/2**  
Mtl 1/2" x 1/4"  
W 4 3/8"  
H 20"  
Wt. 0.37 lb.



**Art. 770/2/DX**  
Mtl 1/2" x 1/4"  
W 4 3/8"  
H 20"  
Wt. 0.37 lb.



**Art. 770/3**  
Mtl 1/2" x 1/4"  
W 4 3/4"  
H 8 11/16"  
Wt. 0.3 lb.



**Art. 770/4**  
Mtl 1/2" x 1/4"  
W 4 3/4"  
H 11 7/16"  
Wt. 0.3 lb.



**Art. 770/5**  
Mtl 1/2" x 1/4"  
W 4 3/4"  
H 14 3/16"  
Wt. 0.4 lb.



**Art. 770/6**  
Mtl 1/2" x 1/4"  
W 4 1/8"  
H 5 7/8"  
Wt. 0.2 lb.



**Art. 770/7**  
Mtl 1/2" x 1/4"  
W 2 15/16"  
H 4 15/16"  
Wt. 0.14 lb.



**Art. 770/8**  
Mtl 1/2" x 1/4"  
W 2 15/16"  
H 4 3/4"  
Wt. 0.13 lb.



**Art. 770/9**  
Mtl 1/2" x 1/4"  
W 3 9/16"  
H 7 1/16"  
Wt. 0.2 lb.



**Art. 770/10**  
Mtl 1/2" x 1/4"  
W 2 3/8"  
H 4 1/2"  
Wt. 0.1 lb.



**Art. 770/14**  
Mtl 3/4" x 1/4"  
W 4 3/4"  
H 7 1/16"  
Wt. 0.2 lb.



**Art. 770/13**  
Mtl 3/4" x 1/4"  
W 5 7/8"  
H 8 7/8"  
Wt. 0.55 lb.



**Art. 1867/7**  
Mtl 1/2" x 1/4"  
W 5 1/2"  
8 15/32"  
Wt. 0.8 lb.



**Art. 1437/16**  
Mtl 3/4" x 1/4"  
W 7 9/32"  
H 10 1/32"  
Wt. 0.2 lb.



**Art. 1437/17**  
Mtl 3/4" x 1/4"  
W 5 7/8"  
H 9 7/8"  
Wt. 0.3 lbs.

## Decorative Aluminum Scrolls



**Art. 1436/1**  
Mtl 3/4" x 1/4"  
W 33 15/32"  
H 13 3/8"  
Wt. 0.5 lb.



**Art. 1436/2**  
Mtl 3/4" x 1/4"  
W 27 9/16"  
H 12 13/64"  
Wt. 0.4 lb.



**Art. 1436/3**  
Mtl 3/4" x 1/4"  
W 24 13/32"  
H 10 15/64"  
Wt. 0.3 lb.



**Art. 1436/4**  
Mtl 3/4" x 1/4"  
W 16 9/64"  
H 11 5/8"  
Wt. 0.3 lb.



**Art. 1436/5**  
9/16" sq.  
W 16 17/32"  
H 11 1/32"  
Wt. 0.5 lb.

## Forged Aluminum



**Art. 1448/4**  
Mtl. 5/32"  
4 17/32" dia.  
hole 3/8" dia



**Art. 1448/5**  
Mtl. 5/32"  
3 1/2" dia.  
hole 1/2" dia.

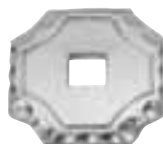

**Art. 1448/6**  
Mtl. 5/32"  
2 15/16" dia.  
hole 1/2"



**Art. 1448/7**  
Mtl. 5/32"  
2 3/4" dia.  
hole 1/2" dia



**Art. 1448/8**  
Mtl 5/16"  
3 1/8" sq.  
Wt. 0.3 lb.



**Art. 1448/9**  
Mtl 5/16"sq.  
W 4"  
H 4"  
Wt. 0.3 lb.



**Art. 1448/10**  
2 3/4" dia.  
H 4 3/4"  
Wt. 1.6 lbs.



**Art. 1448/11**  
1 19/64" dia.  
H 5 1/2"  
Wt. 0.2 lb.



**Art. 140/H/3/ALL**  
Mtl 3/16"  
W 5 9/16"  
H 4 15/16"  
Wt. 0.4 lb.



**Art. 673/3/ALL**  
Mtl 1/4" dia.  
H 5 7/8"  
Wt. 0.4 lb.



**Art. 116/F/11/ALL**  
Mtl 3/4" dia.  
Wt. 0.8 lb.



**Art. 181/10/AL**  
Mtl 1 3/16"  
W 4 1/8"  
H 11 1/4"  
Wt. 1.5 lb.



**Art. 181/11/AL**  
Mtl 1 3/16"  
W 4 1/8"  
H 11 1/4"  
Wt. 1.5 lb.

**Art. 140/H/4/ALL**  
Mtl 3/16"  
W 5 7/8"  
H 7 5/8"  
Wt. 0.9 lb.

# Decorative Aluminum Bars and Handrails

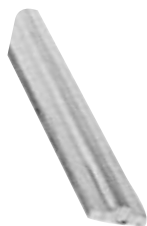

**Art. 772/3**  
Mtl. 9/16" x 5/32"  
Wt. 0.8 lb.  
**Art. 1437/20**  
Mtl. 11/16" x 3/16"  
Wt. 0.8 lb.



**Art. 772/6**  
Mtl 1 9/16" x 5/16"  
Wt. 5.8 lbs.  
**Art. 772/7**  
Mtl 1 3/16" x 5/16"  
Wt. 4.2 lbs.



**HANDRAIL**  
**Art. 1447/10**  
Mtl. 1 7/8" x 9/16"  
Wt. 5.5 lbs

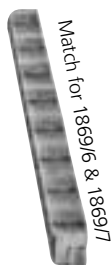

Match for 1869/6 & 1869/7  
Length of bar 20' Approx  
**Art.1370/6/6000/AL**  
Mtl 9/16" sq.  
Wt. 6.8 lbs.



**HANDRAIL**  
**Art. 772/2**  
Mtl 1 9/16" x 5/16"  
L 10' Approx.  
Wt. 5.5 lbs.



**Art. 118/1/AL**  
Mtl 1/2" sq.  
L 10' Approx.



**Art. 772/4**  
Mtl 1 9/16" x 5/16"  
L 10' Approx.  
Wt. 3.3 lbs.  
**Art. 772/5**  
Mtl 1" Sq.  
L 10' Approx.  
Wt. 9.7 lbs.



**Art. 811/5/ALL**  
A 2 1/8"  
B 3/4"  
C 1 9/32"  
D 1 17/32"  
Wt. 9.94 lbs.  
L 20' approx.



**Art. 811/3/ALL**  
A 2 1/4"  
B 7/8"  
C 25/32"  
D 1 17/32"  
Wt. 17.5 lbs.  
L 20' approx.



**Art. 810B/19/ALL**  
A 1 3/4"  
B 9/16"  
C 1"  
D 1 9/32"  
Wt. 10.45 lbs.  
L 20' approx.



**Art. 810/B/15/ALL**  
A 2 1/8"  
B 3/4"  
C 1"  
D 1 17/32"  
Wt. 20.35 lbs.  
L 20' approx.



**Art. 811/7/ALL**  
A 1 3/4"  
B 1 1/16"  
C 1 5/16"  
Wt. 8.46 lbs.  
L 20' approx.



**Art. 811/6/ALL**  
A 2 1/4"  
B 1 5/16"  
C 1 9/16"  
Wt. 8.46 lbs.  
L 20' approx.

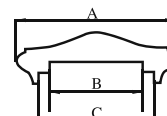
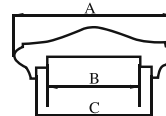
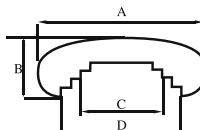
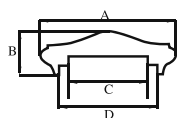
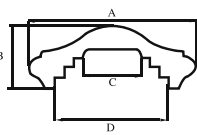
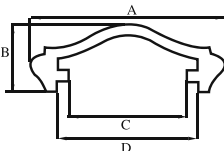

## FOUR SIDES HAMMERED APPROX. L OF TUBES - 20'

- Art. 1871/1** (ex 9187/1) Mtl 3/4" sq. Wt. 5.2 lbs.
- Art. 1871/2** (ex 9187/2) Mtl 1" sq. Wt. 6.6 lbs.
- Art. 1871/3** (ex 9187/3) Mtl 1 3/16" sq. Wt. 7.9 lbs.
- Art. 1871/4** (ex 9187/4) Mtl 1 9/16" sq. Wt. 10.8 lbs.
- Art. 1871/5** (ex 9187/5) Mtl 2 11/32" x 1 3/16" Wt. 12.3 lbs.
- Art. 1871/6** Mtl 2 3/8" x 1 3/16" Wt. 11.5 lbs.
- Art. 1374/15/AL** Mtl 2" sq. - Wt. 13 lbs. Length of bar 10' Approx

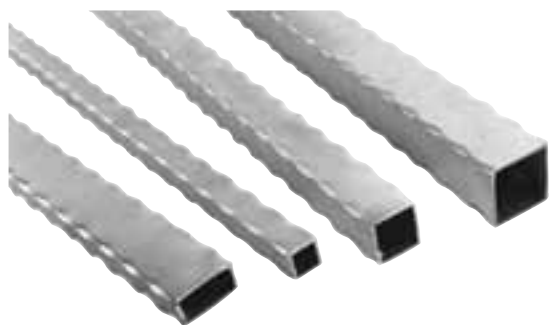

- Art. 1437/1** 3/4" x 1/4" bars
- Art. 1437/2** 9/16" sq. bar + 1/2" x 1/4" bars
- Art. 1437/3** 9/16" sq. bar + 1/2" x 1/4" bars
- Art. 1437/4** 9/16" sq. bar
- Art. 1437/5** 1" sq. bar
- Art. 1437/6** 5/16" sq. bars
- Art. 1437/7** 5/16" sq. bars
- Art. 1437/8** 5/16" sq. bars
- Art. 1437/9** 3/8" sq. bars
- Art. 1437/10** 3/8" sq. bars
- Art. 1437/11** 3/8" x 3/16" bars
- Art. 1437/12** 1/2" x 1/4" bars
- Art. 1437/13** 1/2" x 1/4" bars
- Art. 1437/14** 1/2" x 1/4" bars
- Art. 1437/15** 1/2" x 1/4" bars



- Wt. 1.9 lbs
- Art. 1447/12** for art. 1447/10
- Art. 1447/21** for art. 772/2
- Art. 1447/35** for art. 811/3/ALL
- Art. 1447/36** for art. 811/5/ALL
- Art. 1447/37** for art. 810B/19/ALL
- Art. 1447/38** for art. 810/B/15/ALL



- Wt. 1.1 lbs
- Art. 772/1** for art. 772/2
- Art. 1447/29** for art. 1447/10
- Art. 1447/31** for art. 811/3/ALL
- Art. 1447/32** for art. 811/5/ALL
- Art. 1447/33** for art. 810B/19/ALL
- Art. 1447/34** for art. 810/B/15/ALL

# Decorative Aluminum Components



**Art. 771/1**  
Mtl 1/8"  
W 1 9/16"  
H 4 5/16"  
Wt. 0.1 lb.



**Art. 771/2**  
Mtl 1/8"  
W 1 9/16"  
H 4 5/16"  
Wt. 0.1 lb.



**Art. 116/A/3/A**  
Mtl 3 3/4" dia.  
Wt. 0.4 lb.  
**Art. 771/3**  
Mtl 2 9/16" dia.  
Wt. 0.5 lb.



**Art. 771/4**  
Mtl 1/8"  
W 2 3/4"  
H 2 3/8"  
Wt. 0.1 lb.



**Art. 771/5**  
Mtl 1/8"  
W 2 3/4"  
H 2 3/8"  
Wt. 0.1 lb.

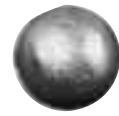

**Art. 771/6**  
Mtl 3/4" dia.  
Wt. .03 lb.

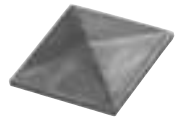

**Art. 167/4/ALL**  
Mtl 1 9/16" sq.  
Wt. .03 lb.

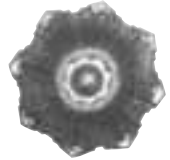

**Art. 757/5**  
Mtl 4 9/64" dia.  
Wt. .15 lb.



**Art. 771/7**  
Mtl 5 1/2"  
9/18" sq.  
Wt. .03 lb.



**Art. 771/8**  
Mtl 7 5/8"  
9/18" dia.  
Wt. .03 lb.



**Art. 771/9**  
Mtl 6 5/16"  
5/8" dia.  
Wt. 0.2 lb.



**Art. 771/10**  
Mtl 5 1/8"  
33/64" dia.  
Wt. 0.1 lb.



**Art. 771/11**  
Base 1/2" dia.  
H 4 15/16"  
Wt. 0.1 lb.



**Art. 771/12**  
Base 19/32" dia.  
H 6 5/16"  
Wt. 0.2 lb.



**Art. 771/13**  
Base 9/18" dia.  
H 5 1/2"  
Wt. 0.3 lb.



**Art. 771/14**  
Base 5/8" dia.  
H 6 5/8"  
Wt. 0.3 lb.



**Art. 772/10**  
Mtl 9/16" sq.  
4" dia.  
Wt. 0.2 lb.



**Art. 772/11**  
Mtl 9/16" sq.  
4 1/2" dia.  
Wt. 0.4 lb.

**Art. 772/12**  
Mtl 9/16" sq.  
5 1/8" dia.  
Wt. 0.5 lb.

**Art. 772/13**  
Mtl 1/2" x 1/4"  
4" dia.  
Wt. 0.1 lb.

**Art. 772/14**  
Mtl 1/2" x 1/4"  
4 1/2" dia.  
Wt. 0.1 lb.

**Art. 772/15**  
Mtl 1/2" x 1/4"  
5 1/8" dia.  
Wt. 0.2 lb.



**Art. 772/8**  
Mtl 9/16" sq.  
W 2 3/8"  
H 5 1/8"  
Wt. 0.2 lb.

**Art. 772/9**  
Mtl 1" x 1"  
W 3 3/4"  
H 7 1/16"  
Wt. 0.9 lb.

**Art. 1443/13**  
Mtl 5/8"  
W 2 31/32"  
H 5 7/8"  
Wt. 0.34 lb.



**Art. 1443/1**  
9/16" sq.  
W 3 15/16"  
H 7 31/64"

**Art. 1443/2**  
9/16" sq.  
W 4 17/32"  
H 7 31/64"

**Art. 1443/3**  
9/16" sq.  
W 5 1/8"  
H 7 31/64"

**Art. 1443/4**  
Mtl 3/4" x 1/4"  
W 3 15/16"  
H 7 31/64"

**Art. 1443/5**  
Mtl 3/4" x 1/4"  
W 4 17/32"  
H 7 31/64"

**Art. 1443/6**  
Mtl 3/4" x 1/4"  
W 5 1/8"  
H 7 31/64"



**Art. 1443/7**  
9/16" sq.  
3 15/16" dia

**Art. 1443/8**  
9/16" sq.  
4 17/32" dia

**Art. 1443/9**  
9/16" sq.  
5 1/8" dia

**Art. 1443/10**  
Mtl 3/4" x 1/4"  
3 15/16" dia

**Art. 1443/11**  
Mtl 3/4" x 1/4"  
4 17/32" dia.

**Art. 1443/12**  
Mtl 3/4" x 1/4"  
5 1/8" dia



Art. 1450/1  
W 3 11/32"  
H 10 5/8"  
5/32" Mtl  
Wt. 0.2 lb.



Art. 1450/2  
W 4"  
H 13"  
5/32" Mtl  
Wt. 0.7 lb.



Art. 1450/3  
W 2"  
H 7 1/16"  
5/32" Mtl  
Wt. 0.2 lb.



Art. 1450/4  
W 4 5/16"  
H 9 1/16"  
5/32" Mtl  
Wt. 0.3 lb.



Art. 1450/5  
W 2 3/8"  
H 3 3/4"  
5/32" Mtl  
Wt. 0.1 lb.



Art. 1450/6  
W 3 3/4"  
H 4 3/4"  
5/32" Mtl  
Wt. 0.1 lb.



Art. 1450/7  
W 3 1/8"  
H 3 1/8"  
5/32" Mtl  
Wt. 0.1 lb.



Art. 1450/8  
W 3 1/8"  
H 6 5/16"  
5/32" Mtl  
Wt. 0.1 lb.



Art. 1450/9  
W 3 3/4"  
H 6 5/8"  
5/32" Mtl  
Wt. 0.1 lb.



Art. 1450/10  
W 3 3/4"  
H 5 7/8"  
5/32" Mtl  
Wt. 0.1 lb.



Art. 1451/1  
1/2" dia.  
W 4 3/4"  
H 8 1/4"  
5/32" Mtl  
Wt. 0.2 lb.



Art. 1451/2  
1/2" dia.  
W 4 3/4"  
H 8 1/4"  
5/32" Mtl  
Wt. 0.2 lb.



Art. 1451/3  
1/2" dia.  
W 4 3/4"  
H 8 5/8"  
5/32" Mtl  
Wt. 0.4 lb.



Art. 1451/4  
1/2" dia.  
W 4 3/4"  
H 8 5/8"  
5/32" Mtl  
Wt. 0.4 lb.



Art. 1451/5  
1/2" dia.  
W 4 3/4"  
H 9 7/16"  
5/32" Mtl  
Wt. 0.3 lb.



Art. 1451/6  
1/2" dia.  
W 4 3/4"  
H 9 7/16"  
5/32" Mtl  
Wt. 0.3 lb.



Art. 1451/7  
1/2" dia.  
W 6 5/16"  
H 4"  
5/32" Mtl  
Wt. 0.2 lb.



Art. 1451/8  
1/2" dia.  
W 6 5/16"  
H 4"  
5/32" Mtl  
Wt. 0.2 lb.



Art. 1451/9  
1/2" dia.  
W 7 7/8"  
H 5 7/8"  
5/32" Mtl  
Wt. 0.3 lb.



Art. 1451/10  
1/2" dia.  
W 7 7/8"  
H 5 7/8"  
5/32" Mtl  
Wt. 0.3 lb.



Art. 1452/1  
1/2" dia.  
W 6 5/16"  
H 4"  
5/32" Mtl  
Wt. 0.2 lb.



Art. 1454/12  
1/2" dia.  
W 7 1/16"  
H 5 1/8"  
Mtl. 5/32"



Art. 1454/13  
1/2" dia.  
W 7 1/16"  
H 5 1/8"  
Mtl. 5/32"



Art. 1454/14  
1/2" dia.  
W 7 1/16"  
H 5 7/8"  
Mtl. 5/32"



Art. 1454/15  
1/2" dia.  
W 5 7/8"  
H 6 5/16"  
Mtl. 5/32"



Art. 1454/16  
1/2" dia.  
W 5 7/8"  
H 6 5/16"  
Mtl. 5/32"

# Forged Aluminum



Art. 1452/2  
1/2" dia.  
W 6 5/16"  
H 4"  
5/32" Mtl  
Wt. 0.2 lb.



Art. 1452/3  
1/2" dia.  
W 3 1/8"  
H 6 5/16"  
5/32" Mtl  
Wt. 0.2 lb.



Art. 1452/4  
1/2" dia.  
W 3 1/8"  
H 6 5/16"  
5/32" Mtl  
Wt. 0.2 lb.



Art. 1452/5  
W 2 3/4"  
H 4 3/4"  
5/32" Mtl  
Wt. 0.1 lb.



Art. 1452/6  
W 2 3/4"  
H 4 3/4"  
5/32" Mtl  
Wt. 0.1 lb.



Art. 1452/7  
1/2" dia.  
W 2 3/4"  
H 4 7/16"  
5/32" Mtl  
Wt. 0.1 lb.



Art. 1452/8  
1/2" dia.  
W 2 3/4"  
H 4 7/16"  
5/32" Mtl  
Wt. 0.1 lb.



Art. 1452/9  
1/2" dia.  
W 3 1/8"  
H 4"  
5/32" Mtl  
Wt. 0.1 lb.



Art. 1452/10  
1/2" dia.  
W 3 1/8"  
H 4"  
5/32" Mtl  
Wt. 0.1 lb.



Art. 1453/1  
Mtl. 5/32"  
W 6 5/16"  
H 14 3/16"



Art. 1453/2  
Mtl. 5/32"  
W 4 5/16"  
H 14 11/64"



Art. 1453/3  
Mtl. 5/32"  
W 4 5/16"  
H 14 11/64"



Art. 1453/4  
Mtl. 5/32"  
W 3 1/32"  
H 9 7/16"



Art. 1453/5  
Mtl. 5/32"  
W 1 49/64"  
H 7 31/64"



Art. 1453/6  
Mtl. 5/32"  
W 1 49/64"  
H 7 31/64"



Art. 1453/7  
Mtl. 5/32"  
W 2 5/32"  
H 3 1/2"



Art. 1453/8  
Mtl. 3/16" dia.  
W 2 11/64"  
H 3 13/16"



Art. 1454/1  
Mtl. 1/2" dia.  
W 8 21/32"  
H 4 17/32"



Art. 1454/2  
Mtl. 1/2" dia.  
W 7 7/8"  
H 2 3/4"



Art. 1454/3  
Mtl. 1/2" dia.  
W 8 21/32"  
H 4 17/32"



Art. 1454/4  
Mtl. 1/2" dia.  
W 9 7/8"  
H 3 1/8"



Art. 1454/5  
4 1/8" dia.  
Mtl. 5/32"



Art. 1454/6  
4 15/16" dia.  
Mtl. 5/32"



Art. 1454/7  
1/2" dia.  
W 3 1/2"  
H 2 9/16"  
Mtl. 5/32"



Art. 1454/8  
1/2" dia.  
W 3 1/2"  
H 2 9/16"  
Mtl. 5/32"



Art. 1454/9  
1/2" dia.  
W 4 3/4"  
H 4 11/32"



Art. 1454/10  
1/2" dia.  
W 4 3/4"  
H 4 11/32"



Art. 1454/11  
1/2" dia.  
W 7 1/16"  
H 5 1/8"  
Mtl. 5/32"

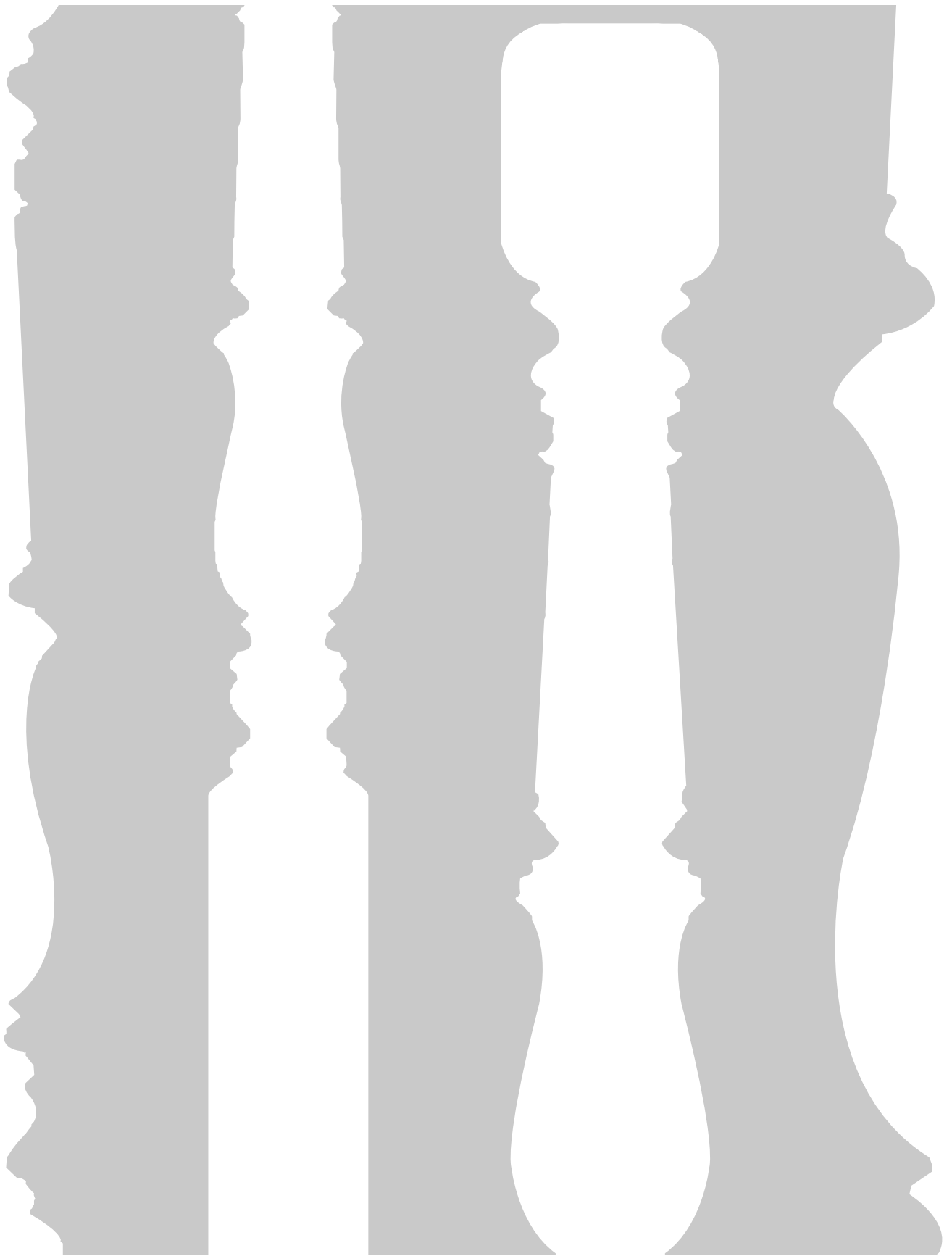

HAND CARVED STAIR PARTS

Quick Reference # 7 2011







We launched our first import, distribution effort into the wood stair business in 2008. After careful evaluation we choose a partner that best represents the high standards associated with the architectural metal components manufactured and offered from our parent company Industria Italiana Arteferro S.p.A.

Introducing The Biltmore Collection from Torneados Muñoz of Spain. This collection of newels, balusters, handrail, and accessories offers a reflection of architectural appointments seen throughout George Vanderbilt's Biltmore House in Asheville, NC, can now be incorporated in your own European inspired new build or remodel. Stocked in Houston the components are offered in white Euro beech for a durable custom stain or finish that are perfect when combined with other white hardwoods such as hard maple, ash, or white oak. Matching new or existing hardwood floors, doors, and crown moulding of various white hardwood species is easily achieved when incorporating these beautiful pieces of carved and etched wood that makes a first impression and lasting one. True art comes one hand carving at a time!

If you yearn for a blend of wood and metal please select from our boutique line of powder coated stair balusters and designer coatings.

- **Newels.....** 187
- **Balusters.....** 190
- **Terminals.....** 192
- **Bases.....** 193
- **Caps.....** 193
- **Square Block.....** 193

**Mod. 11**



**TMBN11A**  
Vanderbilt  
Starter Newel  
W 4 7/16"  
H 43 5/16"  
Wt. 14.2 lbs.  
White Beech



**TMBN11B**  
Vanderbilt  
Mid Newel  
W 3 9/16"  
H 43 5/16"  
Wt. 10.7 lbs.  
White Beech



**TMBB11C**  
Vanderbilt  
Baluster  
W 2 1/16"  
H 43 5/16"  
Wt. 3.4 lbs.  
White Beech

**Mod. 142**



**TMBN142A**  
Gustavino  
Starter Newel  
W 4 7/16"  
H 43 5/16"  
Wt. 17.1 lbs.  
White Beech



**TMBN142B**  
Gustavino  
Mid Newel  
W 3 9/16"  
H 43 5/16"  
Wt. 10.6 lbs.  
White Beech

**Mod. 43**



**TMBC43C**  
Fleur de Lis  
Carved Top  
W 6 7/8" H 5 5/16"  
Wt. 3.1 lbs.  
White Beech



**TMBN43A**  
Fleur de Lis  
Starter Newel  
W 5 7/8" H 29 1/8"  
Wt. 14.8 lbs.  
White Beech



**TMBCB43B**  
Fleur de Lis  
Carved Newel Base  
W 9 1/4" H 13 3/8"  
Wt. 8.2 lbs.  
White Beech

**Mod. 7**



**TMBN7A**  
Sanzio  
Starter Newel  
W 4 7/16"  
H 43 5/16"  
Wt. 16.1 lbs.  
White Beech



**TMBN7B**  
Sanzio  
Mid Newel  
W 3 9/16"  
H 43 5/16"  
Wt. 10.2 lbs.  
White Beech



**TMBB7C**  
Sanzio  
Baluster  
W 2 1/16"  
H 43 5/16"  
Wt. 3.4 lbs.  
White Beech

**Mod. 109**



**TMBN109A**  
Portico  
Starter Newel  
W 4 7/16"  
H 43 5/16"  
Wt. 18.1 lbs.  
White Beech



**TMBN109B**  
Portico  
Mid Newel  
W 3 9/16"  
H 43 5/16"  
Wt. 11.8 lbs.  
White Beech



**TMBB109C**  
Portico  
Baluster  
W 2 1/16"  
H 43 5/16"  
Wt. 3.7 lbs.  
White Beech

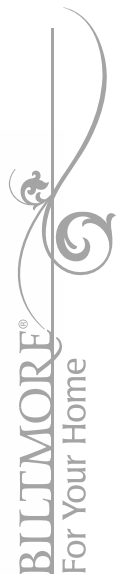

# Torneados Muñoz Handrails, Terminals, and Newels

Matches:  
Mod. 11  
Mod. 22  
Mod. 25



**TM745SR**  
**Mod. 745**  
**Straight Handrail**  
W 2 3/4" H 1 3/4" L 13.12'  
Hand Grip 2 1/4"  
White Beech

Matches:  
Mod. 11  
Mod. 22  
Mod. 25



**TM751SR**  
**Mod. 751**  
**Straight Plowed Handrail**  
W 2 3/4" H 1 3/4" L 13.12'  
Hand Grip 2 1/4"  
White Beech

**TM745BR**  
**Mod. 745**  
**Bending Handrail**  
W 2 3/4" H 1 3/4" L 9' 10"  
Hand Grip 2 1/4"  
White Beech

The Biltmore Collection and Torneados Muñoz collection of hand carved and etched stair parts offer a focal point for a truly one of a kind staircase. The handrail options listed above are special order items and require extended lead times and may require additional shipping charges.

## Mod. 25



**TMBST25R**  
**Mod. 25**  
**Straight Terminal**  
W 6 5/16" H 21 1/4"  
L 21 1/4" Wt. 7.7 lbs.  
White Beech



**TMBRT25D**  
**Mod. 25**  
**Right Terminal**  
W 6 5/16" H 21 1/4"  
L 21 1/4" Wt. 6.9 lbs.  
White Beech



**TMBLT25I**  
**Mod. 25**  
**Left Terminal**  
W 6 5/16" H 21 1/4"  
L 21 1/4" Wt. 6.9 lbs.  
White Beech



**TMBN25A**  
**Mod. 55**  
**Starter Newel**  
W 9 13/16" H 30 1/2"  
Wt. 15.6 lbs.  
White Beech



**TMBCB25B**  
**Mod. 25**  
**Claw Newel Base**  
W 7 1/2" H 6 5/16"  
L 6 5/16" Wt. 3.6 lbs.  
White Beech

## Mod. 11



**TMBST11R**  
**Mod. 11**  
**Straight Terminal**  
W 5 7/8" H 19 11/16"  
L 19 11/16" Wt. 5.5 lbs.  
White Beech



**TMBRT11D**  
**Mod. 11**  
**Right Terminal**  
W 5 7/8" H 19 11/16"  
L 19 11/16" Wt. 5 lbs.  
White Beech



**TMBLT11I**  
**Mod. 11**  
**Left Terminal**  
W 5 7/8" H 19 11/16"  
L 19 11/16" Wt. 5 lbs.  
White Beech

Mod. 11 Terminals match the Mod. 11 and Mod. 24 Newel and Baluster Collections.

**Mod. 112**



**TMBN112A**  
Mod. 112  
Starter Newel  
W 4 7/16"  
H 43 5/16"  
Wt. 16.1 lbs.  
White Beech



**TMBN112B**  
Mod. 112  
Mid Newel  
W 3 9/16"  
H 43 5/16"  
Wt. 10 lbs.  
White Beech



**TMBB112C**  
Mod. 112  
Baluster  
W 2 1/16"  
H 43 5/16"  
Wt. 3.8 lbs.  
White Beech

**Mod. 40**



**TMBN40A**  
Mod. 40  
Starter Newel  
W 8 11/16"  
H 31 1/8"  
Wt. 25 lbs.  
White Beech



**TMBT40C**  
Mod. 40  
Left Terminal  
W 6 1/8" H 17 13/16"  
L 17 13/16" Wt. 4.5 lbs.  
White Beech



**TMBCB40B**  
Mod. 40  
Carved Newel Base  
W 8 11/16" H 6 7/8"  
L 6 7/8" Wt. 4.8 lbs.  
White Beech

**Mod. 215**



**TMBCB215**  
Mod. 215  
Carved Newel Base  
H 10 5/8" W 7 7/8" L 10 5/8"  
Wt. 8.8 lbs.  
White Beech

**Mod. 24**

**TMBN24A**  
Mod. 24  
Starter Newel  
W 7 7/8" H 29 1/2"  
Wt. 9.9 lbs.  
White Beech



**TMBCB24B**  
Mod. 24  
Claw Newel Base  
W 6 5/16" H 6 5/16"  
L 6 5/16" Wt. 2.3 lbs.  
White Beech



Other species are available for all wood products including American Cherry, Walnut and Red Oak.

# Torneados Muñoz Hand Carved Balusters & Newels

## Mod. 14



**TMBN14A**  
Mod. 14  
Starter Newel  
W 6 5/16"  
H 46 1/16"  
Wt. 18.4 lbs.  
White Beech



**TMBB14B**  
Mod. 14  
Baluster  
W 5 7/8"  
H 41 5/16"  
Wt. 4.5 lbs.  
White Beech



**TMBN15A**  
Mod. 15  
Starter Newel  
W 6 5/16"  
H 46 1/16"  
Wt. 17.8 lbs.  
White Beech



**TMBB14B**  
Mod. 15  
Baluster  
W 5 7/8"  
H 41 5/16"  
Wt. 4.4 lbs.  
White Beech

## Mod. 45



**TMBN45A**  
Mod. 45  
Starter Newel  
W 11 7/16"  
H 42 1/2"  
Wt. 17.6 lbs.  
White Beech

## Mod. 22



**TMBN22A**  
Mod. 22  
Starter Newel  
W 4 7/16"  
H 43 5/16"  
Wt. 15.8 lbs.  
White Beech



**TMBN22B**  
Mod. 22  
Mid Newel  
W 3 9/16"  
H 43 5/16"  
Wt. 8.6 lbs.  
White Beech



**TMBB22C**  
Mod. 22  
Baluster  
W 2 1/16"  
H 43 5/16"  
Wt. 3.8 lbs.  
White Beech



**TMBST22R**  
Mod. 22  
Straight Terminal  
W 5 7/8" H 19 11/16"  
L 19 11/16" Wt. 5.4 lbs.  
White Beech



**TMBRT22D**  
Mod. 22  
Right Terminal  
W 5 7/8" H 19 11/16"  
L 19 11/16" Wt. 5.5 lbs.  
White Beech



**TMBLT22I**  
Mod. 22  
Left Terminal  
W 5 7/8" H 19 11/16"  
L 19 11/16" Wt. 5.5 lbs.  
White Beech

# Torneados Muñoz Hand Carved Newels

Suggested Carved Caps



**TMBTS35G1**  
Mod. 35  
Newel Block  
W 4 7/16" H 5 1/8"  
L 5 1/8" Wt. 2.5 lbs.  
White Beech



**TMBTS35G2**  
Mod. 35  
Newel Block  
W 3 9/16" H 5 1/8"  
L 5 1/8" Wt. 1.4 lbs.  
White Beech



**TMBTS35H1**  
Mod. 35  
Newel Block  
W 4 7/16" H 5 1/8"  
L 5 1/8" Wt. 2.5 lbs.  
White Beech



**TMBTS35H2**  
Mod. 35  
Newel Block  
W 3 9/16" H 5 1/8"  
L 5 1/8" Wt. 1.5 lbs.  
White Beech



**TMBTS35I1**  
Mod. 35  
Newel Block  
W 4 7/16" H 5 1/8"  
L 5 1/8" Wt. 2.5 lbs.  
White Beech



**TMBTS35I2**  
Mod. 35  
Newel Block  
W 3 9/16" H 5 1/8"  
L 5 1/8" Wt. 1.5 lbs.  
White Beech



**TMBA35J1**  
Mod. 35  
Newel Block  
W 4 7/16" H 9 13/16"  
L 9 13/16" Wt. 4.2 lbs.  
White Beech



**TMBA35J2**  
Mod. 35  
Newel Block  
W 3 9/16" H 9 13/16"  
L 9 13/16" Wt. 2.5 lbs.  
White Beech



**TMBA35K1**  
Mod. 35  
Newel Block  
W 4 7/16" H 9 13/16"  
L 9 13/16" Wt. 4.5 lbs.  
White Beech



**TMBA35K2**  
Mod. 35  
Newel Block  
W 3 9/16" H 9 13/16"  
L 9 13/16" Wt. 2.5 lbs.  
White Beech



**TMBA35L1**  
Mod. 35  
Newel Block  
W 4 7/16" H 9 13/16"  
L 9 13/16" Wt. 4.5 lbs.  
White Beech



**TMBA35L2**  
Mod. 35  
Newel Block  
W 3 9/16" H 9 13/16"  
L 9 13/16" Wt. 2.5 lbs.  
White Beech



**TMBTB35M1**  
Mod. 35  
Top Block  
W 5 11/16" H 1 3/4"  
L 1 3/4" Wt. 1.3 lbs.  
White Beech



**TMBTB35M2**  
Mod. 35  
Top Block  
W 4 3/4" H 1 3/4"  
L 1 3/4" Wt. 0.9 lbs.  
White Beech



**TMBCB35N1**  
Mod. 35  
Central Block  
W 5 11/16" H 1"  
L 1" Wt. 0.8 lbs.  
White Beech



**TMBCB35N2**  
Mod. 35  
Central Block  
W 4 3/4" H 1"  
L 1" Wt. 0.6 lbs.  
White Beech



**TMBN35A**  
Mod. 35  
Starter Newel  
W 4 7/16" H 38 3/16"  
Wt. 17.2 lbs.  
White Beech



**TMBN35B**  
Mod. 35  
Mid Newel  
W 3 9/16" H 38 3/16"  
Wt. 12 lbs.  
White Beech

Other species are available for all wood products including American Cherry, Walnut and Red Oak.



Mod. 35

HAND CARVED STAIR PARTS

# Torneados Muñoz Hand Carved Newels Caps



**TMBSRC700A**  
Mod. 700  
Round Cap - Striped  
W 4 7/16" H 8 1/16"  
L 8 1/16" Wt. 1.7 lbs.  
White Beech



**TMBSRC700B**  
Mod. 700  
Round Cap - Striped  
W 3 9/16" H 6 1/2"  
L 6 1/2" Wt. 0.9 lbs.  
White Beech



**TMBC680A**  
Mod. 680  
Acorn Cap - Smooth  
W 4 7/16" H 9 7/16"  
L 9 7/16" Wt. 2.1 lbs.  
White Beech



**TMBC680B**  
Mod. 680  
Acorn Cap - Smooth  
W 3 9/16" H 7 1/16"  
L 7 1/16" Wt. 1.2 lbs.  
White Beech



**TMBRC705A**  
Mod. 705  
Round Cap - Smooth  
W 4 7/16" H 8 1/16"  
L 8 1/16" Wt. 1.8 lbs.  
White Beech



**TMBRC705B**  
Mod. 705  
Round Cap - Smooth  
W 3 9/16" H 6 1/2"  
L 6 1/2" Wt. 1 lbs.  
White Beech



**TMBC690A**  
Mod. 690  
Acorn Cap - Carved  
W 4 7/16" H 9 7/16"  
L 9 7/16" Wt. 1.9 lbs.  
White Beech



**TMBC690B**  
Mod. 690  
Acorn Cap - Carved  
W 3 9/16" H 7 1/16"  
L 7 1/16" Wt. 1.1 lbs.  
White Beech



**TMBT695A**  
Mod. 695  
Square Cap  
W 5 1/2" H 1 7/8"  
L 1 7/8" Wt. 1.2 lbs.  
White Beech



**TMBT695B**  
Mod. 695  
Square Cap  
W 4 3/4" H 1 7/8"  
L 1 7/8" Wt. 0.8 lbs.  
White Beech

Other species are available for all wood products including American Cherry, Walnut and Red Oak.



**TMBCC235A**  
Mod. 235  
Mushroom Cap - Carved  
W 5 11/16" H 4 1/8"  
L 4 1/8" Wt. 1 lbs.  
White Beech



**TMBCC235A**  
Mod. 235  
Mushroom Cap - Carved  
W 4 3/4" H 3 15/16"  
L 3 15/16" Wt. 0.6 lbs.  
White Beech



**Mod. 700**

## Custom Finishes For Carved Wood

We can provide a quote for any or the custom finishes listed below on any newel, baluster or terminal from Torneados Muñoz. Each quote may differ because of the parts utilized and quantities listed. Lead times and minimums would also be quoted along with special set-up charges. Please inquire for possible samples to be finished prior to committing to a full project. Accent any project with one of a kind looks using paints and coatings by master finishers of Spain!



Madrid



Barcelona



Valencia



Sevilla



Bilbao



Zaragoza



Malaga



Murcia



Las Palmas



Palma



Gijon



Vigo



Alacant



Cordoba



Valladolid



Herrera



A Caruna



Granada



Vitoria



Santa Cruz



Najera



Padron



Quesada



Raquena



Tarazona









POWDER COATED PICKETS

Quick Reference # 7 2011

# Introduction to Powder Coated Balusters

## COLOR OPTIONS

CLASSIC BLACK CB



DARK CHAMPAGNE DC



WROUGHT IRON BLACK WIB



SHADOW GREY SG



MIDNIGHT BRONZE MB



WARM NICKEL WN



OLD WORLD COPPER OWC



ALL ITEMS ARE AVAILABLE UNCOATED

Shown: PC26/1, PC33/1, PC18/1, PC18/2



We offer a spectacular Powder Coat Line of high quality Italian Wrought Iron balusters and newels in seven magnificent colors. We offer unique selections in stunning colors that have been created to satisfy even the most selective Builders and Homeowners.

We are one of the first manufacturers to provide Twist Designs, including baskets, in 1/2", 9/16" and 5/8" bar sizes. This gives your customer's options they've never had until now.

We provide a lavish assortment in our Scroll Series, some designs are exclusive to the Indital line. Our styles include seven scrolls in widths over 7" and seven in widths under 6".

We offer several original eye-catching shapes; geometric designs, our single and double stars and Gonzato Designs complete the most extensive Powder Coat Line in the marketplace.

Our color selection includes two colors of black; **Classic Black** (Satin) and **Wrought Iron Black** (Textured) and five rich colors from **Old World Copper**, **Midnight Bronze**, **Dark Champagne**, **Warm Nickel** and **Shadow Grey**.

India Spa, our staff, and our manufacturing facility in Europe are working passionately to bring our customers this impressive line.

We are committed to be the leader in providing quality Powder Coat Stair Products to the U S market.

Shown: PC16/1, PC16/2

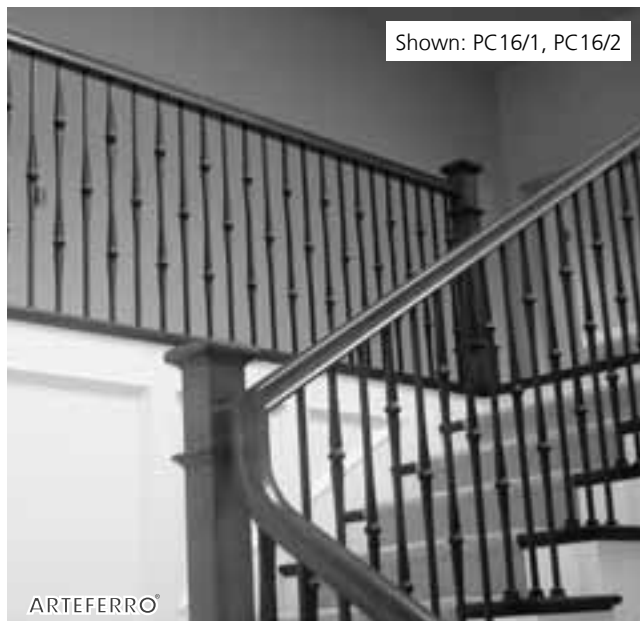



**Art. PC4/1**  
Mtl 1/2" sq.  
H 44 3/32"  
Wt. 3 lbs.  
**Art. PC4/2**  
Mtl 9/16" sq.  
H 44 3/32"  
Wt. 3.08 lbs.  
**Art. PC4/3 \***  
Mtl 5/8" sq.  
H 44 3/32"  
Wt. 3.16 lbs.



**Art. PC4/4**  
Mtl 1/2" sq.  
H 44 3/32"  
Wt. 2.86 lbs.  
**Art. PC4/5**  
Mtl 9/16" sq.  
H 44 3/32"  
Wt. 3 lbs.  
**Art. PC4/6 \***  
Mtl 5/8" sq.  
H 44 3/32"  
Wt. 3.4 lbs.



Hammered

**Art. PC8/4**  
Mtl 1/2" sq.  
H 44 3/32"  
Wt. 3.3 lbs.  
**Art. PC8/5**  
Mtl 9/16" sq.  
H 44 3/32"  
Wt. 3.7 lbs.  
**Art. PC8/6 \***  
Mtl 5/8" sq.  
H 44 3/32"  
Wt. 4.1 lbs.



**Art. PC8/1**  
Mtl 1/2" sq.  
H 44 3/32"  
Wt. 3 lbs.  
**Art. PC8/2**  
Mtl 9/16" sq.  
H 44 3/32"  
Wt. 3.04 lbs.  
**Art. PC8/3 \***  
Mtl 5/8" sq.  
H 44 3/32"  
Wt. 3.08 lbs.



Shown: PC4/1, PC4/4



Round Bar

**Art. PC28/2**  
Mtl 1/2" dia.  
H 44 3/32"  
Wt. 2.8 lbs  
Plain  
**Art. PC28/3**  
Mtl 9/16" dia.  
H 44 3/32"  
Wt. 3.2 lbs  
Plain  
**Art. PC28/4**  
Mtl 5/8" dia.  
H 44 3/32"  
Wt. 3.6 lbs  
Plain



Square Bar

**Art. PC28/5**  
Mtl 1/2" sq.  
H 44 3/32"  
Wt. 2.8 lbs  
Plain  
**Art. PC28/6**  
Mtl 9/16" sq.  
H 44 3/32"  
Wt. 3.2 lbs  
Plain  
**Art. PC28/7**  
Mtl 5/8" sq.  
H 44 3/32"  
Wt. 3.6 lbs  
Plain

ALL ITEMS ARE AVAILABLE UNCOATED

\* AVAILABLE COLORS: CLASSIC BLACK (CB) AND WROUGHT IRON BLACK (WIB)

Shown: PC6/1, PC4/1



POWDER COATED PICKETS

ARTEFERRO

ALL ITEMS ARE AVAILABLE UNCOATED



**Art. PC6/4**  
Mtl 1/2" sq.  
H 44 3/32"  
Wt. 3.2 lbs.

**Art. PC6/5**  
Mtl 9/16" sq.  
H 44 3/32"  
Wt. 3.6 lbs.

**Art. PC6/6 \***  
Mtl 5/8" sq.  
H 44 3/32"  
Wt. 3.8 lbs.



**Art. PC6/1**  
Mtl 1/2" sq.  
H 44 3/32"  
Wt. 2.97 lbs.

**Art. PC6/2**  
Mtl 9/16" sq.  
H 44 3/32"  
Wt. 3 lbs.

**Art. PC6/3 \***  
Mtl 5/8" sq.  
H 44 3/32"  
Wt. 3.4 lbs.

\* AVAILABLE COLORS: CLASSIC BLACK (CB) AND WROUGHT IRON BLACK (WIB)

Shown: PC10/1



**Art. PC10/1**  
Mtl 9/16" sq.  
H 44 3/32"  
Wt. 2.97 lbs.  
**Art. PC10/2 \***  
Mtl 5/8" sq.  
H 44 3/32"  
Wt. 3.37 lbs.  
Hammered



**Art. PC10/3**  
Mtl 9/16" sq.  
H 44 3/32"  
Wt. 3.2 lbs.  
**Art. PC10/4 \***  
Mtl 5/8" sq.  
H 44 3/32"  
Wt. 3.6 lbs.  
Hammered



POWDER COATED PICKETS

\* AVAILABLE COLORS: CLASSIC BLACK (CB) AND WROUGHT IRON BLACK (WIB)

ARTEFERRO

Powder Coated Hammered Design



Mtl 9/16" x 9/16" sq. Hammered on two sides



Art. PC12/1  
Mtl 9/16" sq.  
H 44 3/32"  
Wt. 4.4 lbs.



Mtl 9/16" x 9/16" sq. Hammered on two sides

Art. PC16/1  
Mtl 9/16" sq.  
H 44 3/32"  
Wt. 3.85 lbs.



Mtl 9/16" x 9/16" sq. Hammered on two sides

Art. PC16/2  
Mtl 9/16" sq.  
H 44 3/32"  
Wt. 4.15 lbs.



Hammered

Art. PC18/3  
Mtl 9/16" sq.  
H 44 3/32"  
Wt. 4.3 lbs.

Shown: PC12/1, PC16/1



Forged

Art. PC18/1  
Mtl 9/16" sq.  
H 44 3/32"  
Wt. 3.5 lbs.



Art. PC18/2  
Mtl 9/16" sq.  
H 44 3/32"  
Wt. 4.3 lbs.

ALL ITEMS ARE AVAILABLE UNCOATED

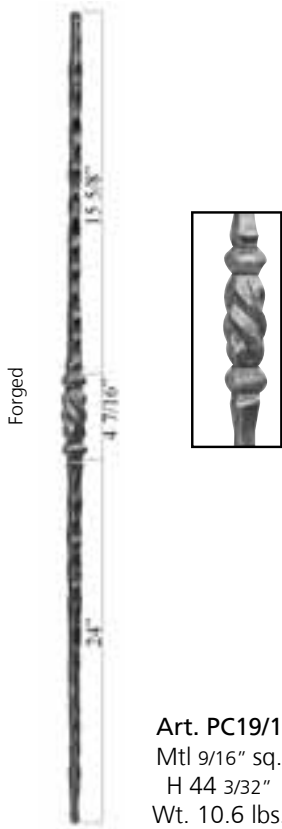

**Art. PC19/1**  
 Mtl 9/16" sq.  
 H 44 3/32"  
 Wt. 10.6 lbs.

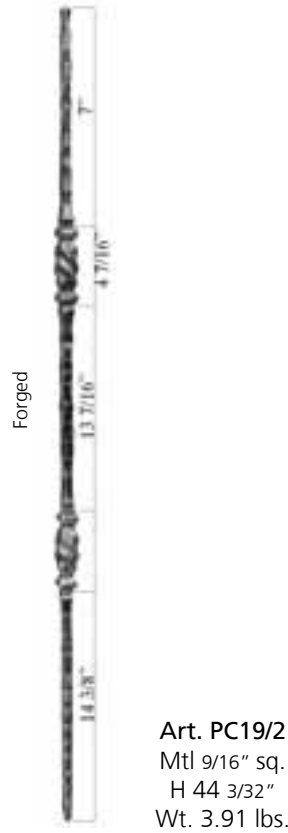

**Art. PC19/2**  
 Mtl 9/16" sq.  
 H 44 3/32"  
 Wt. 3.91 lbs.



**Art. PC52/1**  
 Mtl 5/8" sq.  
 W 3 5/8"  
 H 44 3/32"  
 Wt. 5.5 lbs.  
 Hammered

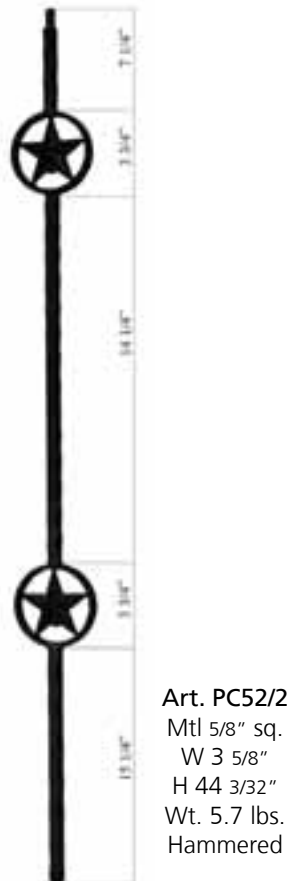

**Art. PC52/2**  
 Mtl 5/8" sq.  
 W 3 5/8"  
 H 44 3/32"  
 Wt. 5.7 lbs.  
 Hammered

ALL ITEMS ARE  
 AVAILABLE UNCOATED





Shown: PC47/1



POWDER COATED PICKETS



Art. PC46/1  
 Mtl 9/16" sq.  
 H 44 3/32"  
 Wt. 3.7 lbs.



Art. PC47/1  
 Mtl 1/2" sq.  
 W 4"  
 H 44 3/32"  
 Wt. 5.6 lbs.



Art. PC48/1  
 Mtl 1/2" sq.  
 W 2 3/4"  
 H 44 3/32"  
 Wt. 5 lbs.



Art. PC50/1  
 Mtl 1/2" sq.  
 W 4 3/4"  
 H 44 3/32"  
 Wt. 3.5 lbs.

ALL ITEMS ARE AVAILABLE UNCOATED



Art. PC45/1  
Mtl 9/16" sq.  
W 4 3/4"  
H 44 3/32"  
Wt. 2.75 lbs.



Art. PC45/2  
Mtl 9/16" sq.  
W 4 3/4"  
H 44 3/32"  
Wt. 3.3 lbs.



Art. PC49/1  
Mtl 1/2" sq.  
W 1 9/16"  
H 44 3/32"  
Wt. 2.3 lbs.



Art. PC49/2  
Mtl 1/2" sq.  
W 1 9/16"  
H 44 3/32"  
Wt. 3.7 lbs.



# Powder Coated Scrolls Design



**Art. PC20/1**  
Mtl 1/2" sq.  
W 7 9/32"  
H 44 3/32"  
Wt. 4.8 lbs.



**Art. PC22/1**  
Mtl 1/2" sq.  
W 7 3/8"  
H 44 3/32"  
Wt. 8.03 lbs.  
Plain

**Art. PC22/2**  
Mtl 1/2" sq.  
W 7 3/8"  
H 44 3/32"  
Wt. 8.03 lbs.  
Hammered



**Art. PC22/3**  
Mtl 1/2" sq.  
W 5 3/4"  
H 44 3/32"  
Wt. 6.6 lbs.  
Plain

**Art. PC22/4**  
Mtl 1/2" sq.  
W 5 3/4"  
H 44 3/32"  
Wt. 6.6 lbs.  
Hammered



**Art. PC22/5**  
Mtl 1/2"x 1/4"  
W 5 3/4"  
H 44 3/32"  
Wt. 3.96 lbs.  
Plain

Shown: PC20/1



Shown: PC20/1, PC49/1, PC49/2



POWDER COATED PICKETS

ARTEFERRO

Shown: PC32/1, PC16/1, PC16/2



POWDER COATED PICKETS



Art. PC32/1  
Mtl 1/2" x 1/4"  
W 5 7/8"  
H 44 3/32"  
Wt. 4.1 lbs.  
Plain



Art. PC33/1  
Mtl 1/2" sq.  
W 5 5/16"  
H 44 3/32"  
Wt. 5.5 lbs.  
Hammered



Art. PC33/2  
Mtl 1/2" sq.  
W 4 15/16"  
H 44 3/32"  
Wt. 6.6 lbs.  
Hammered



Art. PC26/1  
Mtl 1/2" sq.  
W 7 3/4"  
H 44 3/32"  
Wt. 6.9 lbs  
Hammered



ALL ITEMS ARE  
AVAILABLE UNCOATED

Need help with the design and layout of your staircase?

# STEPONE *Designer*®

Create your custom pattern of powder coated parts and hand carved wood.

Save, print, and even email your designs.

Easy to use drag and drop designs are a mouse click away.



Open Stringer



Closed Stringer



Balcony





Art. PC24/1  
Mtl 1/2" sq.  
W 6 5/8"  
H 44 3/32"  
Wt. 4.4 lbs



Art. PC28/1  
Mtl 1/2" sq.  
W 7 9/32"  
H 44 3/32"  
Wt. 9.7 lbs  
Plain





# Powder Coated Scroll and Ribbon Design

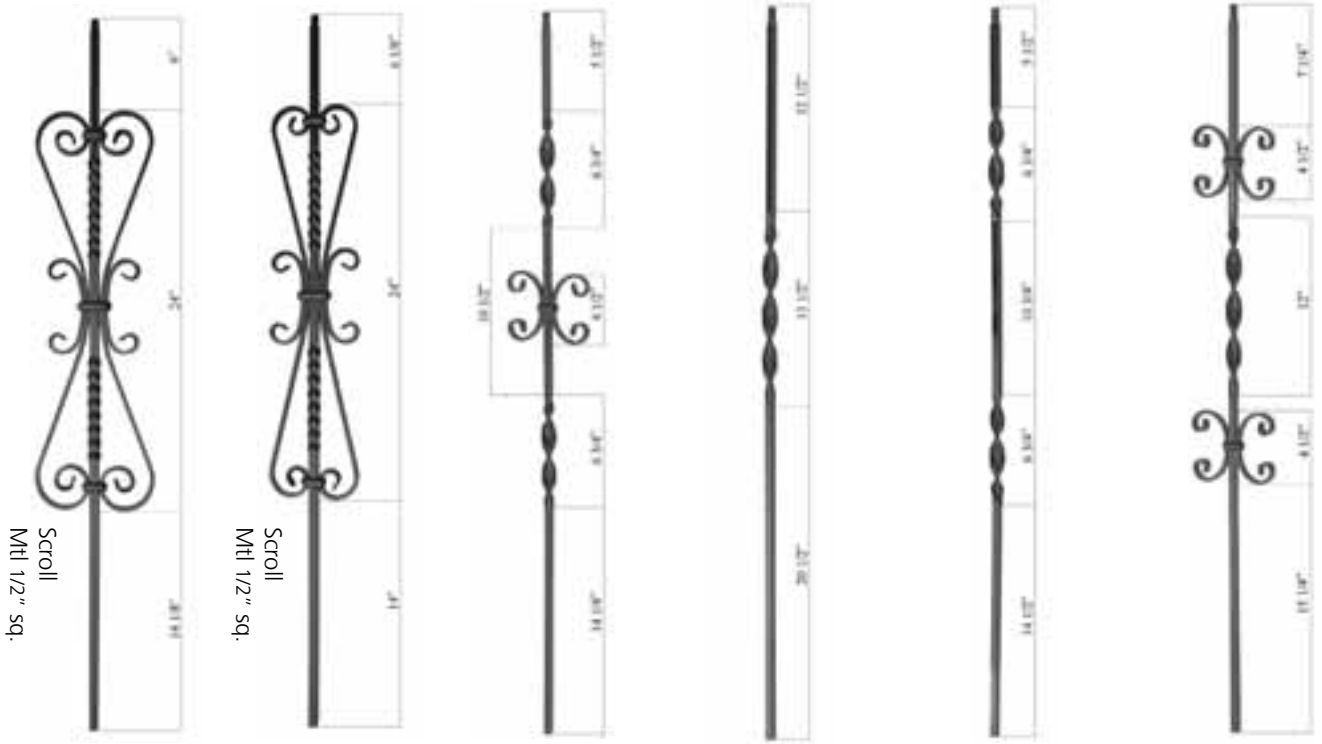

Shown: PC34/3, PC34/4



POWDER COATED PICKETS



Art. PC38/1  
Mtl 9/16" sq.  
H 44 3/32"  
Wt. 4.1 lbs



Art. PC38/2  
Mtl 9/16" sq.  
H 44 3/32"  
Wt. 4.1 lbs



Art. PC38/3  
Mtl 9/16" sq.  
W 5 7/8"  
H 44 3/32"  
Wt. 4.3 lbs



Art. PC40/1  
Mtl 9/16" sq.  
W 4 1/2"  
H 44 3/32"  
Wt. 4.8 lbs



Art. PC42/1  
Mtl 9/16" dia.  
H 44 3/32"  
Wt. 2.6 lbs



Art. PC42/2  
Mtl 9/16" dia.  
H 44 3/32"  
Wt. 2.6 lbs



Art. PC44/1  
Mtl 9/16" dia.  
W 6 7/8"  
H 44 3/32"  
Wt. 4.3 lbs.



Art. PC44/2  
Mtl 9/16" dia.  
W 6 7/8"  
H 44 3/32"  
Wt. 3.45 lbs.



Shown: PC38/1, PC38/3

ALL ITEMS ARE AVAILABLE UNCOATED

Shown: PC60/2

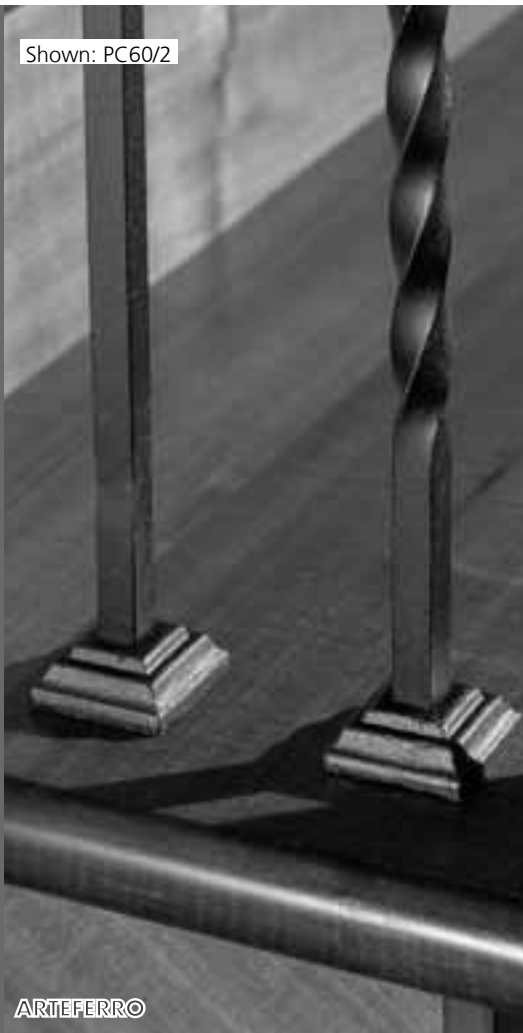

ARTEFERRO



**Art. PC60/17/AL**

Mtl 1 1/4" sq.

Mtl 11/16" hole fits 5/8" Balusters

Wt. 0.13 lbs.

**Art. PC60/6/AL**

Mtl 1 3/16" x 1 31/32"

Mtl 5/8" hole fits 9/16" Balusters

Wt. 0.13 lbs.

**Art. PC60/1/AL**

Mtl 1 3/16" x 1 31/32" sq.

Mtl 9/16" hole fits 1/2" Balusters

Wt. 0.13 lbs.



**Art. PC60/5**

Mtl 2 3/4" x 1 3/4"

Mtl 1 7/32" hole

Wt. 1 lb.

**Art. PC60/3/AL**

Mtl 1 9/16" x 1 3/32"

Mtl 9/16" hole fits 1/2" Balusters

Wt. 0.13 lbs.

**Art. PC60/4/AL**

Mtl 1 9/16" x 1 3/32"

Mtl 5/8" hole fits 9/16" Balusters

Wt. 0.13 lbs.

**Art. PC60/16**

Mtl 1 1/2" x 1 1/8"

Mtl 11/16" hole fits 5/8" Balusters

Wt. 0.13 lbs.



**Art. PC60/8**

Mtl 2 23/64" sq.

Mtl 1 1/4" hole fits 1 3/16" Newel posts

Wt. 0.24 lbs.



**Art. PC60/7**

Mtl 19/32" sq. hole

W 2 1/8"

H 1/2"

fits 9/16" Balusters

Wt. 0.6 lbs.

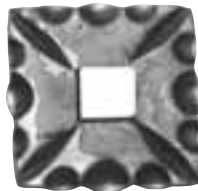

**Art. PC60/10**

Mtl 3 5/32" x 3 5/32" x 5/16"

Mtl 19/32" dia. hole

Wt. 0.88 lbs.



**Art. PC60/9**

Mtl 1 9/16" dia. x 1 17/32"

37/64" dia. hole

Wt. 0.28 lbs.

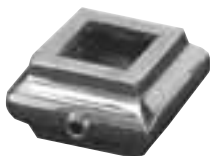

**Art. 160/D/10**

Mtl 25/32" x 1 3/8" x 1 3/8"

Mtl 9/16" hole

Wt. 0.13 lbs.

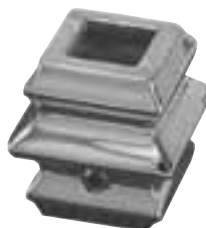

**Art. 160/D/11**

Mtl 1 9/16" x 1 1/2" x 1 1/2"

Mtl 9/16" hole

Wt. 0.13 lbs.



**Art. PC60/13**

Mtl 1 9/16" dia. x 19/32"

Mtl 9/16" dia. hole

Wt. 0.8 lbs.



**Art. PC56/1**  
Mtl 1 3/16" sq.  
H 48"  
Wt. 18.70 lbs.  
Hammered



**Art. PC56/2**  
Mtl 1 3/16" dia.  
H 48"  
Wt. 14.50 lbs.  
Hammered



**Art. PC56/3**  
Mtl 1" sq.  
H 48"  
Wt. 17.25 lbs.  
Forged



**Art. PC57/1**  
Mtl 1 3/16" sq.  
H 48"  
Wt. 18.7 lbs.



ARTEFERRO



**Art. PC58/1**  
Mtl 1 3/16" sq.  
H 48"  
Wt. 19.80 lbs.



**Art. PC58/2**  
Mtl 1 3/16" sq.  
H 48"  
Wt. 19.60 lbs.



**Art. PC58/3**  
Mtl 1 3/16" sq.  
H 48"  
Wt. 18.65 lbs.



**Art. PC57/2**  
Mtl 1 3/16" dia.  
H 48"  
Wt. 17.26 lbs.



ARTEFERRO

POWDER COATED PICKETS

ALL ITEMS ARE AVAILABLE UNCOATED



Shown: PC54/1

ARTEFERRO®



Art. PC54/1  
Mtl 9/16" sq.  
H 44 3/32"  
Wt. 3.4 lbs.



Shown: PC55/2

ARTEFERRO®



Art. PC55/2  
Mtl 9/16" sq.  
H 44 3/32"  
Wt. 3.8 lbs.



Art. PC55/1  
Mtl 9/16" sq.  
H 44 3/32"  
Wt. 3.9 lbs.



Art. PC55/3  
Mtl 9/16" sq.  
H 44 3/32"  
Wt. 4.1 lbs.

ALL ITEMS ARE AVAILABLE UNCOATED

## Replace Wooden Balusters With Powder Coated Iron Balusters For a Visual Upgrade

Iron spindles, also known as iron balusters, can be replaced to upgrade and beautify your home. There are quite a few different styles available online.

Interested in doing it yourself? Installation is easier than you might think, especially if you are replacing existing wood balusters. The following steps take you from concept to completion!



### Visit a design center to decide on styles and materials needed.

Our website offers a virtual staircase builder. If you go to the physical showroom of a local stair builder, lumberyard or home store that carries iron balusters, bring a rough draft of your plans, or, better yet, a photo of your existing staircase. Count how many spindles that you need and decide what design and color you want for your new iron pickets.

There are many decorative coatings in the marketplace. Replacing softwood, carpeted treads with a hardwood tread may impact your color choice for the baluster coating, as well as the length of the balusters needed. Also, remember to consider spacial limitations in your choice of baluster. For example, the iron scroll design looks great but might not fit in some installations if the balusters are too closely spaced.

It is not necessary, from a mechanical or aesthetic point of view, to replace the bottom post on your wooden railing. Leaving the original base post, rather than replacing it with an iron post, will keep your railing system as strong or stronger than the original!

Next, choose the correct size spindle shoes. The shoes will cover up the rough, damaged or unfinished areas at the top and bottom of the baluster left from removal of the original wooden baluster. The width of the shoe must cover that space. Shoes come with different size holes to fit the diameter of the spindle.

### Now that you have your materials, time to remove the old balusters.

After placing a drop cloth/masking to protect furniture, home décor and electronics from sawdust, cut the wood balusters in the middle using a jig-saw or reciprocating saw. Hold the wood baluster firmly when cutting to prevent damage to the stair tread or underside of the railing. Wiggle and/or twist the cut baluster to loosen it, as it may be glued and/or nailed, depending on the original contractor's preference.

Examine the holes for any nails, wood filler or glue. Use pliers to remove any nails. Depending on the baluster size, you may need to use a chisel or drill to clean out residual wood, filler or glue. Any small defects still visible after the iron baluster installation can be repaired with colored putty or wax.

You can use your existing rail (if it is a simple hole; not a plowed rail with fillet) or for new rails drill based on local spacing code requirements. You can use a pencil to mark on the new rail after using a measuring tape. Drill holes to accommodate no deeper than 1/2" on the rail and the tread.

**Important:** Always cut the new iron baluster approximately 1 1/2 inch longer than the distance from the tread to the rail to accommodate the insert portion of the baluster into the rail and tread. Cut from the bottom to fit to size depending on the rake of the stairs or balcony height. **Never cut at the pin-top or doweled end, which is the top.** When in doubt about the precise length, play it safe and cut the baluster a little long and trim it if it doesn't fit. They won't grow back!

### Use a high-grade, thick 2-part epoxy for the top rail hole and bottom tread hole.



Choose an epoxy that is a putty when mixed, not a flowing liquid, to keep the mess to a minimum. A brand used with success on many projects is PC Woody, a two-part epoxy that is thick enough to hold the balusters straight without clamping but allows repositioning for over a half-hour, depending on the temperature. Common denatured alcohol will remove any uncured epoxy. It is neither necessary nor desirable to fill the holes to the top with the epoxy. Just put enough to stabilize the baluster. After the epoxy sets, you can finish filling the upper or lower holes with more epoxy or another wood filler, if desired.

Insert the doweled or pin-top end into the rail portion first and then the bottom part into the tread. (If installing an upper shoe, be sure to put it onto the baluster before inserting it!!)

Prior to fastening the bottom to the tread slip an iron shoe over the spindle. Once the bottom is fastened, slide the shoe down to fit tightly against the tread. Usually the shoes come with set screws that can be tightened with an Allen wrench against the spindle. Use pitched shoes for rakes with pony walls or flat shoes for cut stringers or balconies.

Check the level of the balusters before the epoxy sets, usually within an hour, though check the label on your epoxy to be sure of the setting time!

**You're done! Enjoy your remodeled staircase!**

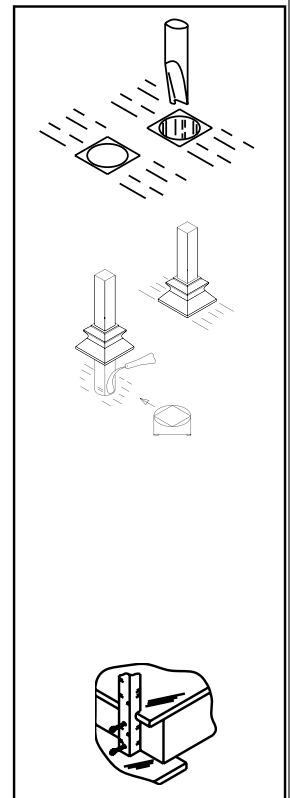

Shown: PC24/1

POWDER COATED PICKETS







arteferro

# ARTEFERRO INOX

THE STAINLESS STEEL RAILING SYSTEM



We offer an expanded selection of complimenting parts for bar, glass, and cable systems from its stainless railing line Arteferro INOX. Choose from an increased assortment of newels, handrail supports, finials, glass clips, accessories and unique designs such as the international acclaimed cubed line. The modular system allows for flexibility for part considerations and ease of installation vs. comparable welded systems. An architectural focal point begins with best-in-class selection for aesthetic, clean lines setting up a purely contemporary project.

We are also proud to offer for the first time a stocking programming in Houston that drops into systems that meet light commercial applications! For test certification data please speak with your Indital USA sales representative.

For installation instructions please review the series of videos in our **DOWNLOAD** section of [www.indital.com](http://www.indital.com). Additional projects shots can be reviewed in our **GALLERY** area to assist with your own respective vision or you can choose to upload your specific rail project dimensions, images, or information at **ARCHITECTS CORNER** under Custom Parts and Design Assistance. We will route your information to closet qualified installation specialists.

A pre-galvanized system similar to INOX stainless was developed and officially launched in 2008 after careful evaluation of budget consensus projects that yearned for the same look as INOX yet wanted a simple, cost effective alternative. STEELNOX offers the flexibility to paint in the field using truly artistic colors from reds, blacks, white, or vary hues including stainless coatings! Early adopters are enjoying an off-the-shelf parts system only sourced through Indital USA. All that is needed after tapping and drilling holes is the ability to re-galvanize the areas using easy to source sprays to eliminate the potential for corrosion prior to priming and painting. This is a great alternative for decking, cable projects on top of standard contemporary applications often seen in modern lofts for stair railings. Many of the same principles apply to choosing parts for the system, handing, and the tools necessary to complete the job as INOX.

For installation instructions please review the series of videos in our **DOWNLOAD** section of [www.indital.com](http://www.indital.com) under INOX. Additional projects shots can be reviewed in our **GALLERY** area to assist with your own respective vision under STEELNOX or you can choose to upload your specific rail project dimensions, images, or information at **ARCHITECTS CORNER** under Custom Parts and Design Assistance. We will route your information to closet qualified installation specialists.

- Tube & Anchorages ..... 218
- Handrail Support..... 221
- Curves & Fittings..... 225
- Round Bar Holders..... 227
- Cube System..... 228
- Glass Clamps..... 229

- End Caps and Spherical Finials ..... 232
- Newel Posts..... 234
- Profile System..... 247
- Cable System..... 250
- Woodinox..... 253
- Accessories & Schematics..... 255



Ø = diameter



AISI 304	AISI 316	Iron	Dimensions
E0011	E4806		1 1/3" dia. x 5/64" x 9'- 10"
E0011/6000	E4806/6000		1 1/3" dia. x 5/64" x 19'- 8"
E001/38	E4801/38		1 1/2" dia. x 5/64" x 9'- 10"
E001/38/6000	E4801/38/6000		1 1/2" dia. x 5/64" x 19'- 8"
E001	E4801	I001	1 2/3" dia. x 5/64" x 9'- 10"
E001/6000	E4801/6000	I001/6000	1 2/3" dia. x 5/64" x 19'- 8"
E0014			2" dia. x 5/64" x 9'- 10"
E0014/6000			2" dia. x 5/64" x 19'- 8"
E00204040	E10204040		1 9/16" x 1 9/16" x 5/64" x 9' x 10" Square Tube



AISI 304	AISI 316	Iron	Dimensions
E0052			5/16" dia. x 9'- 10"
E0052/6000			5/16" dia. x 19'- 8"
E0051			3/8" dia. x 9'- 10"
E0051/6000			3/8" dia. x 19'- 8"
E005	E4851	I005	1/2" dia. x 9'- 10"
E005/6000	E4851/6000	I005/6000	1/2" dia. x 19'- 8"
E0050			9/16" dia. x 9'- 10"
E0050/6000			9/16" dia. x 19'- 8"

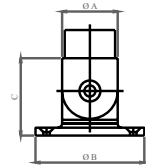

AISI 316	For tube	A	B	C
E4483	1 2/3" dia. x 5/64"		3 17/64"	2 23/64"

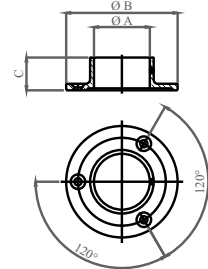

AISI 316	For tube	A	B	C
E456/38	1 1/2" dia. x 5/64"			
E456	1 2/3" dia. x 5/64"		3 15/16"	1"

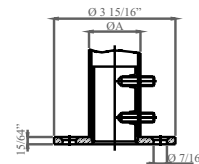

AISI 304	Iron	For tube	A
E0212		1 1/3" dia. x 5/64"	
E0213	I0213	1 2/3" dia. x 5/64"	

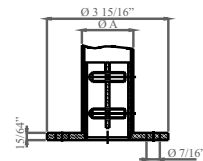

AISI 316	Dimensions	For tube	A
E403	3 15/16" dia. x 15/64" 3 holes 7/16" dia.	1 2/3" dia. x 5/64"	

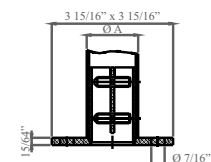

AISI 316	For tube	For tube	A
E404304	Square plate 3 15/16" Sq. 4 holes 7/16" dia.	1 2/3" dia. x 5/64"	

Ø = diameter

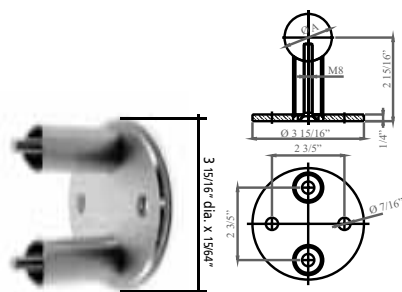

AISI 304	AISI 316	For tube A
E400/304	E400	1 2/3" dia. x 5/64"

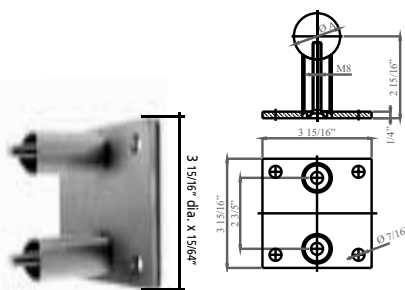

AISI 304	AISI 316	For tube A
E401/304	E401	1 2/3" dia. x 5/64"

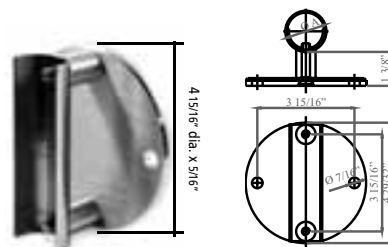

AISI 304	For tube A
E111/38	1 1/2" dia. x 5/64"
E111	1 2/3" dia. x 5/64"

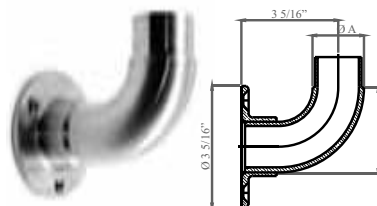

AISI 316	For tube A
E4561	1 2/3" dia. x 5/64"

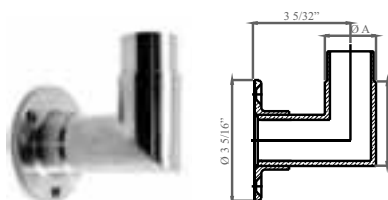

AISI 316	For tube A
E4566	1 2/3" dia. x 5/64"

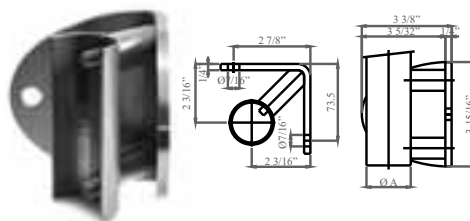

AISI 304	For tube A
E1114	1 2/3" dia. x 5/64"

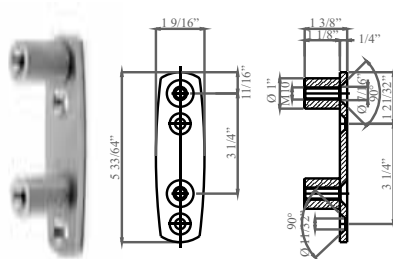

AISI 304	Dimensions
E112	5 33/64" x 1 9/16" x 1 3/8"

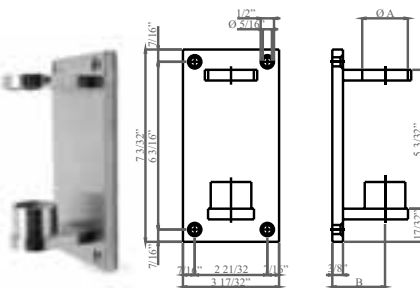

AISI 316	For tube A	B
E406	1 2/3" dia. x 5/64"	1 15/16"

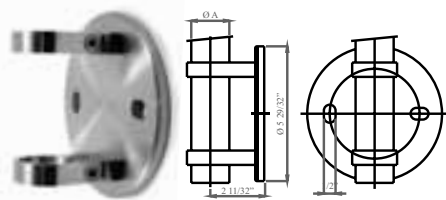

AISI 304	For tube A
E116	1 2/3" dia. x 5/64"

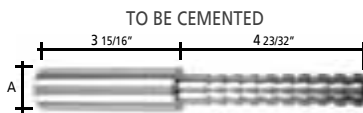

ALUMINIUM	For tube A	
E0131	1 1/3" dia. x 5/64"	1 5/32"
E013	1 2/3" dia. x 5/64"	1 1/2"

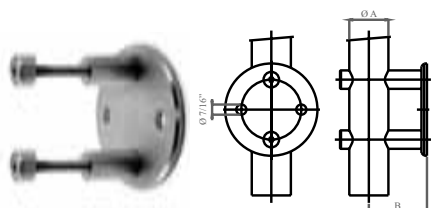

AISI 304	For tube A	B
E11420	1 2/3" dia. x 5/64"	2 31/64"
E11440	Flat face	

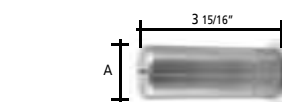

ALUMINIUM	For tube A	
E0141	1 1/3" dia. x 5/64"	1 5/32" blind hole M8
E014	1 2/3" dia. x 5/64"	1 1/2" blind hole M8



ARTIFERRO

ARTIFERRO INOX

Ø = diameter

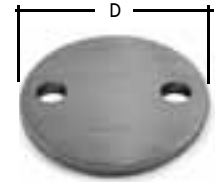
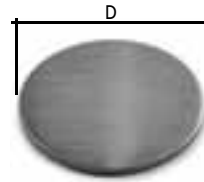

AISI 304	AISI 316	Iron	Dimensions A	Hole F	Height H
E0191			3 15/64" dia.	1 23/64" dia.	19/32"
E019/38	E4019/38		3 15/64" dia.	1 1/2" dia.	19/32"
E019			3 15/64" dia.	1 11/16" dia.	19/32"
E020	E4072	I020	4 9/64" dia.	1 11/16" dia.	19/32"
E020/38	E4072/38		4 9/64" dia.	1 11/16" dia.	19/32"
	E4073		4 9/64" dia.	1 15/16" dia.	63/64"
			5 5/64" dia.	1 11/16" dia.	63/64"
E0204			5 5/64" dia.	1 15/16" dia.	63/64"
E02011			4 9/64" dia.	2" dia.	63/64"
	E4077		5 45/64" dia.	2 13/32" dia.	63/64"
E0181			2 7/16" dia.	1/2" dia.	19/32"
E0182		I0182	2 63/64" dia.	1/2" dia.	1/2" dia.
E0183			2 63/64" dia.	37/64" dia.	1/2" dia.

AISI 304	D
E064	3 5/32" dia. x 5/32"
E065	3 15/16" dia. x 5/32"

AISI 304	D
E0682	3 15/16" dia. x 15/64"

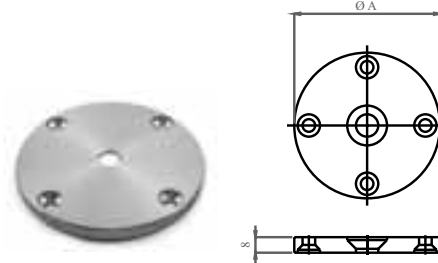

ALUMINIUM	Dimensions A	External holes	Internal hole
E015	2 11/64" dia.	3 x 15/64" dia.	5/16" dia.
E016	2 61/64" dia.	4 x 15/64" dia.	5/16" dia.
E017	3 47/64" dia.	4 x 15/64" dia.	5/16" dia.

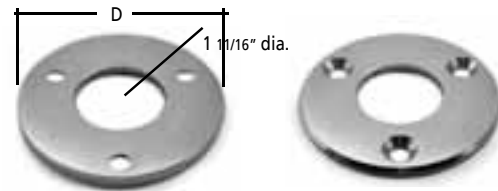
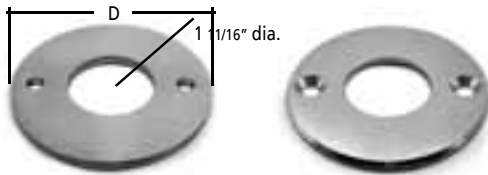

AISI 304	D	Central hole	External holes
E0691	3 15/16" dia. x 15/64"	1 11/16"	2 x 23/64" dia.
E0691/D	3 15/16" dia. x 15/64"	1 11/16"	2 x 23/64" dia.

Countersunk holes and chamfered perimeter

AISI 304	D	Central hole	External holes
E0696	3 15/16" dia. x 15/64"	1 11/16"	3 x 23/64" dia.
E0696/D	3 15/16" dia. x 15/64"	1 11/16"	3 x 23/64" dia.

Countersunk holes and chamfered perimeter



Ø = diameter

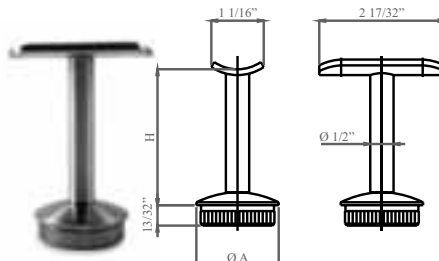
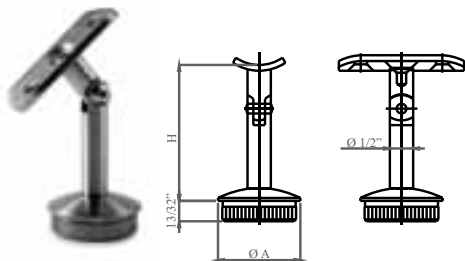

AISI 303	AISI 316	Iron	For tube A	H
E0301			1 1/3" dia x 5/64"	2 61/64"
E030/S	E030/S/316	I030/S1	1 2/3" dia x 5/64"	2 61/64"
E030/S/38	E030/S/38/316		1 1/2" dia x 5/64"	2 61/64"
E030/S1	E030/S1316		2" dia x 5/64"	2 61/64"

AISI 303	AISI 316	Iron	For tube A	H
E0311			1 1/3" dia x 5/64"	2 61/64"
E031/S38	E031/S38/316		1 1/2" dia x 5/64"	2 61/64"
E031/S1	E031/S1316	I031/S1	1 2/3" dia x 5/64"	2 61/64"
E031/S2			2" dia x 5/64"	2 61/64"

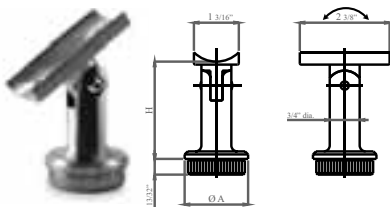

AISI 304	For tube A	H
E030	1 2/3" dia. x 5/64"	2 1/4"

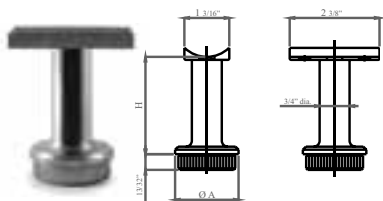

AISI 304	For tube	H
E031	1 2/3" dia x 5/64"	2 1/4"

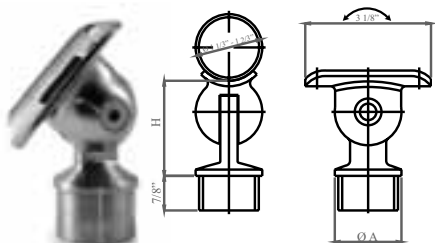

AISI 316	For tube A	H
E4581	1 2/3" dia. x 5/64"	2 23/64"

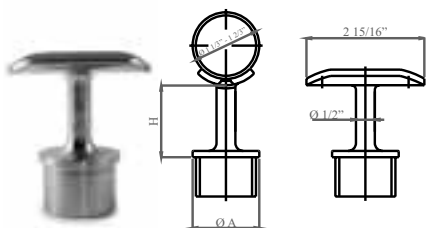

AISI 316	For tube A	H
E458	1 2/3" dia.	2"

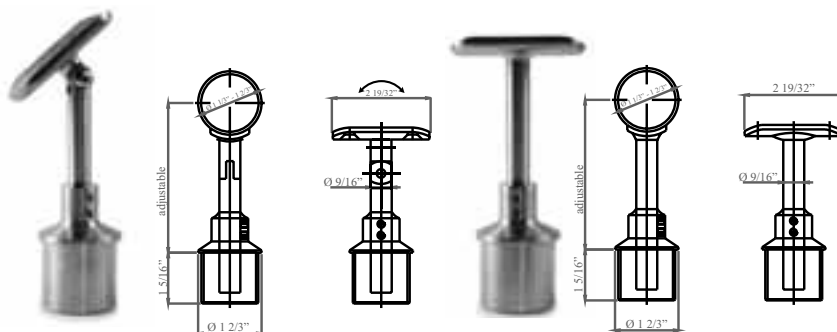

AISI 316	For tube
E500/424	1 2/3" dia. x 5/64"

AISI 316	For tube
E510/424	1 2/3" dia. x 5/64"



Ø = diameter

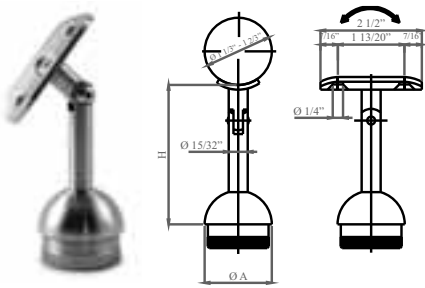

**AISI 303** For tube A H

E039100 1 2/3" dia. x 5/64" 3 15/32"

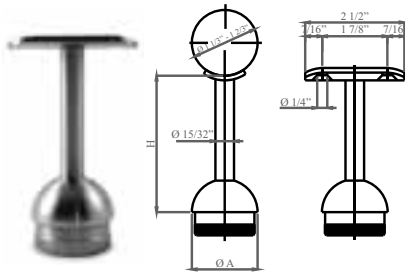

**AISI 303** For tube A H

E039300 1 2/3" dia. x 5/64" 3 15/32"

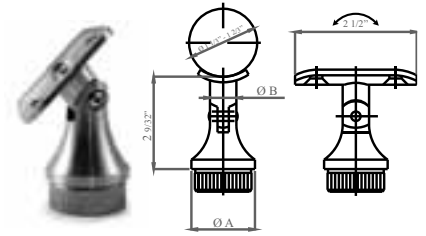

**AISI 303 AISI 316** For tube A B

E0104 E0104316 1 2/3" dia. x 5/64" 3/4" dia.

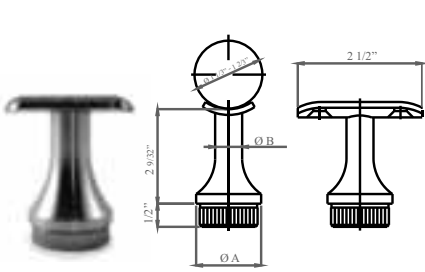

**AISI 303 AISI 316** For tube A B

E0102 E0102316 1 2/3" dia. x 5/64" 3/4" dia.

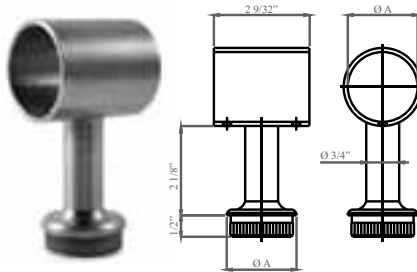

**AISI 303** For tube A

E031/5 1 2/3" dia. x 5/64"

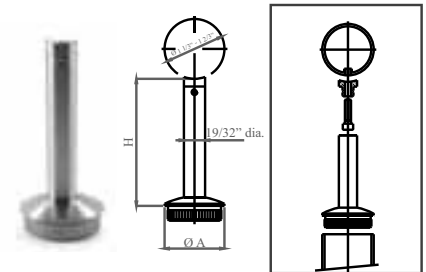

**AISI 303** For tube A H

E038500 1 2/3" dia. x 5/64" 3 3/4"

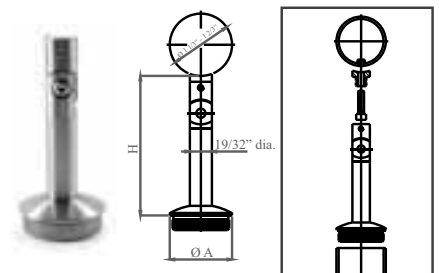

**AISI 303** For tube A H

E038700 1 2/3" dia. x 5/64" 3 3/4"



Ask for our complete catalog  
[www.arteferro.com](http://www.arteferro.com)

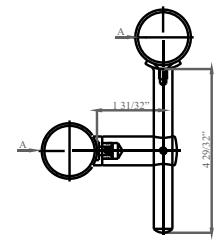
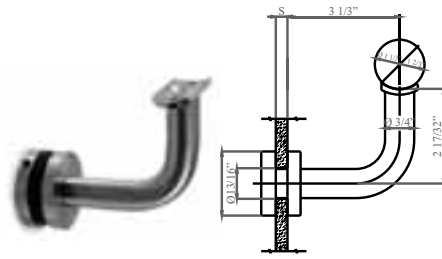
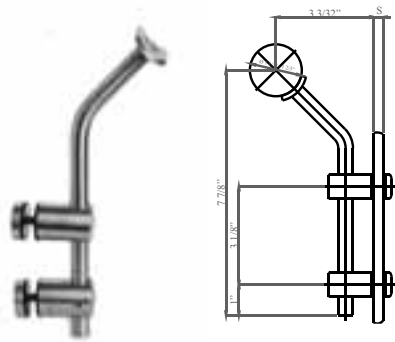

AISI 304	AISI 316	Description S
E035300	E035300316	For glass thickness 5/16" - 1" Glass to be drilled at 55/64" dia.

AISI 303	AISI 316	Description S
E022/S1	E022/S1316	For glass thickness 5/16" - 1" Glass to be drilled at 55/64" dia.

AISI 303	Dimensions	For tube A
E0225	1/2" dia. x 4 59/64"	1 1/8" - 1 2/8" dia.
E0226	9/16" dia. x 4 59/64"	1 1/8" - 1 2/8" dia.

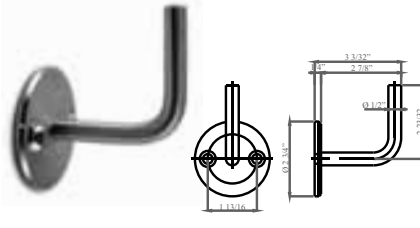
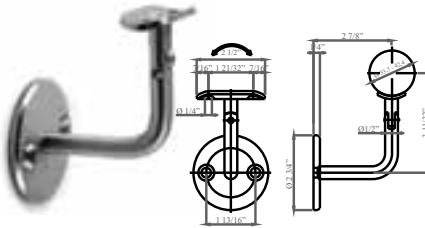
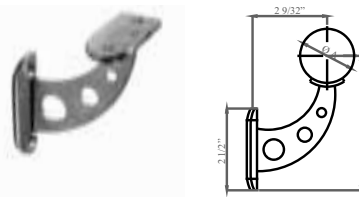

AISI 303	For tube A
E031/S6	1 2/8" dia.

AISI 304	AISI 316	For tube
E02231/38		1 1/2" dia.
E02231	E02231316	1 2/8" dia.

AISI 304	Description
E0222	Without thread

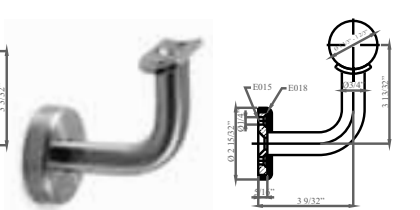
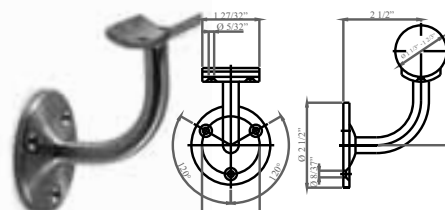
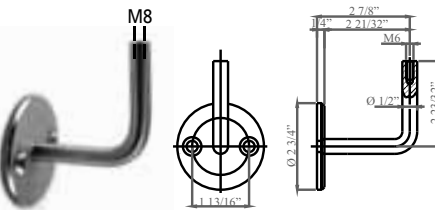

AISI 304	Description
E0224	With internal thread M6

AISI 316	For tube
E459	1 2/8" dia.

AISI 304	For tube
E022/S	1 2/8" dia.

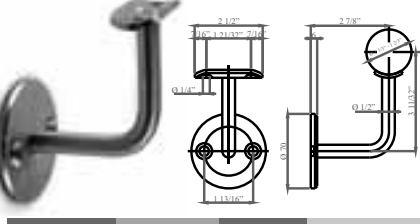
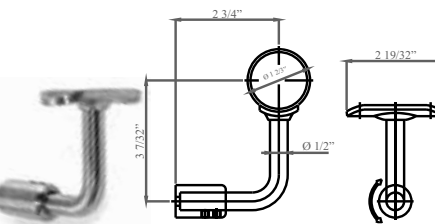

AISI 316	For tube A
E4583/424	1 2/8" dia.
E4583	square

AISI 304	AISI 316	Iron	For tube
E0223/38			1 1/2" dia.
E0223	E0223316	I0223	1 2/8" dia.

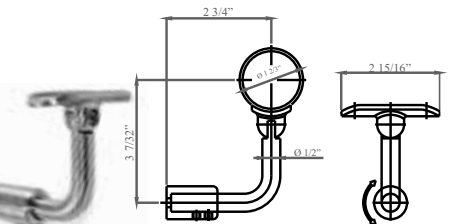

AISI 316	For tube A
E4584/424	1 2/8" dia.



Ask for our complete catalog  
[www.arteferro.com](http://www.arteferro.com)

Ø = diameter

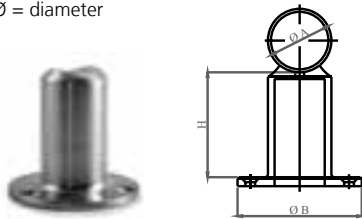

AISI 316	For tube A	B	H
E4541	1 2/3" dia.	3 17/64" dia.	2 41/64"



AISI 316	For tube A	H
E491	1 2/3" dia. x 5/64"	1/2"
E494	2" dia. x 5/64"	5/8"

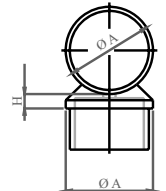
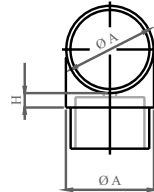

AISI 316	For tube A	H
E454	1 2/3" dia. x 3/32"	1/4"
E2054	2" dia. x 5/64"	23/64"

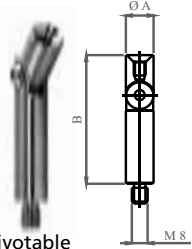

Pivotable

AISI 304	Description	A x B
E011931		1/2" dia. x 2 9/16"

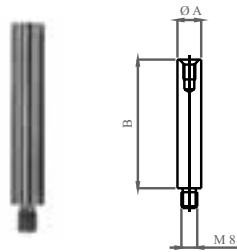

AISI 304	Description
E011941	1/2" dia. x 2 9/16"

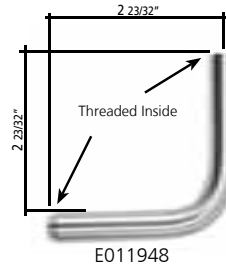

E011948

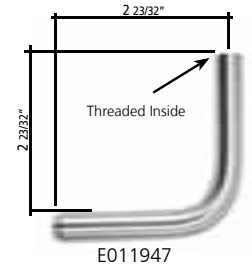

E011947

AISI 304	Description
E011947	With 1 internal thread M6
E011948	With 2 internal threads M6

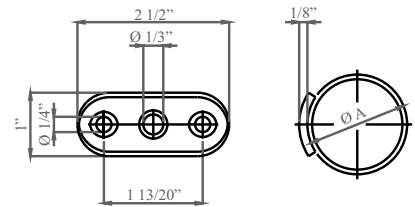

AISI 304	For tube A
E01197/38	1 1/2" dia
E01197	1 2/3" dia
E011976	Flat face

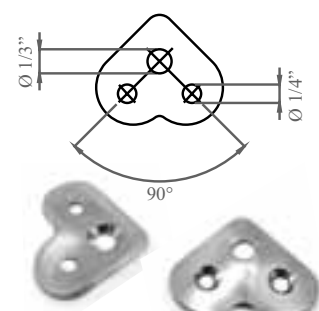

AISI 304	For tube
E011971	1 2/3" dia.

Curves can be custom made for any angle. Contact Indital for details.

Ø = diameter

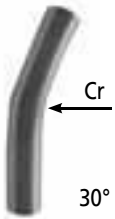

30°

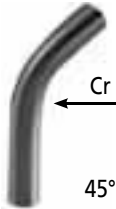

45°

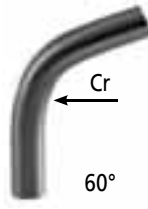

60°

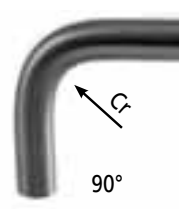

90°

AISI 303	For tube	Cr
E028/30	1 2/3" dia x 5/64"	4 11/64"
E0281/30	1 1/3" dia x 5/64"	3 11/32"

AISI 303	For tube	Cr
E028/45	1 2/3" dia x 5/64"	4 11/64"
E0281/45	1 1/3" dia x 5/64"	3 11/32"

AISI 303	For tube	Cr
E028/60	1 2/3" dia x 5/64"	4 11/64"
E0281/60	1 1/3" dia x 5/64"	3 11/32"

AISI 303	Iron	For tube	Cr
E028/90	I028/90	1 2/3" dia x 5/64"	4 11/64"
E0281/90		1 1/3" dia x 5/64"	3 11/32"



180°

AISI 303	For tube	X
E028/180	1 2/3" dia x 5/64"	10 3/16"
E0281/180	1 1/3" dia x 5/64"	8 7/16"

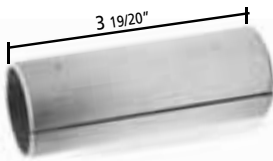

BRASS	Art. no.	For tube
	E024	1 2/3" dia x 5/64"
	E0241	1 1/3" dia x 5/64"

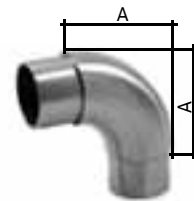
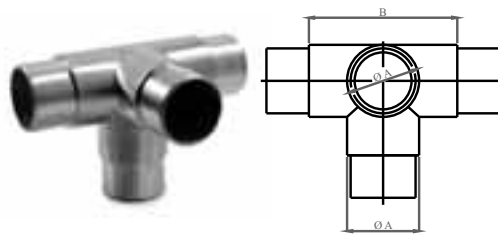
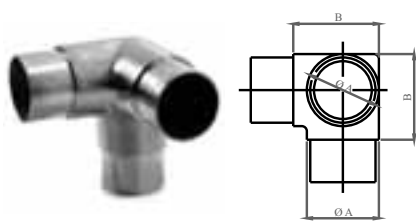

AISI 316	For tube	A	B
E2031	1 1/3" dia. x 5/64"	2 11/64"	
E203/38	1 1/2" dia. x 5/64"	2 11/64"	
E203	1 2/3" dia. x 5/64"	2 3/4"	
E20321	2" dia. x 5/64"	2 23/64"	

AISI 316	For tube	A	B
E2035	1 2/3" dia. x 5/64"	3 1/2"	

AISI 316	Iron	For tube	A
E450/38		1 1/2" dia. x 5/64"	2 33/64"
E450	I450	1 2/3" dia. x 5/64"	2 9/16"
E2004		2" dia. x 5/64"	3 1/16"

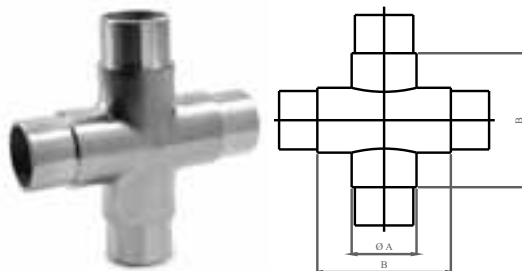
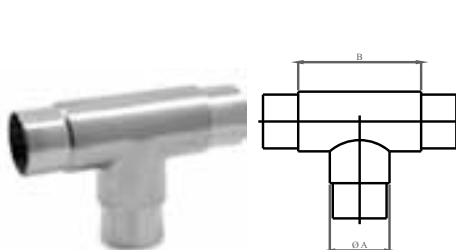

AISI 316	Iron	For tube	A	B
E453/38		1 1/2" dia. x 5/64"	3 7/16"	
E453	I453	1 2/3" dia. x 5/64"	3 7/16"	
E20371		2" dia. x 5/64"	2 41/64"	

AISI 316	For tube	A	B
E2045	1 2/3" dia. x 5/64"	3 7/16"	

AISI 316	For tube
E4471/38	1 1/2" dia. x 5/64"
E4471	1 2/3" dia. x 5/64"





AISI 316	Iron	For tube
E451/38		1 1/2" dia. x 5/64"
E451	I451	1 2/3" dia. x 5/64"
E2014		2" dia. x 5/64"



AISI 316	Iron	For tube
E446/38		1 1/2" dia. x 5/64"
E446	I446	1 2/3" dia. x 5/64"

### BENDABLE TUBE CONNECTORS EASY TO BEND

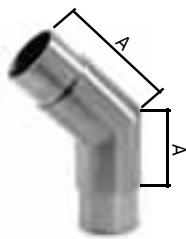

AISI 316	ZAMAC	For tube	A
E2015	I2015	1 2/3" dia. x 5/64"	2"
E2020		2" dia. x 5/64"	2"



AISI 316	For tube
E4491	1 2/3" dia. x 5/64"



AISI 316	For tube
E455200	1 2/3" dia. x 5/64"



AISI 316	For tube
E455/38	1 1/2" dia. x 5/64"
E455	1 2/3" dia. x 5/64"
E20621	2" dia. x 5/64"



For welded applications.

AISI 316	For tube
E5587	1 2/3" dia. x 5/64"

AISI 304	AISI 316	For tube
E706	E802	1 2/3" dia. x 5/64"



Ø = diameter

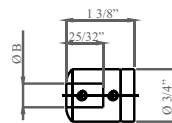
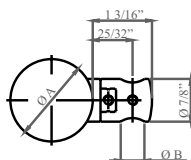
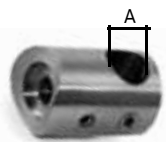

AISI 303	AISI 316	Iron	For tube A	Hole B
E006911			1 1/3" dia.	1/2" dia. through
E006913			1 1/3" dia.	9/16" dia. through
E0069/38			1 1/2" dia.	1/2" dia. through
E006910			1 2/3" dia.	13/32" dia. through
E0069	E4042	I0069	1 2/3" dia.	1/2" dia. through
E00691			1 2/3" dia.	9/16" dia. through
E00692			Flat face	1/2" dia. through
E006914			2" dia.	1/2" dia. through
			2" dia.	9/16" dia. through

AISI 316	For tube	Round bar B
E40651	Flat face	1/2" dia.

AISI 316	For tube	Round bar B
E41651	Round face	1/2" dia.

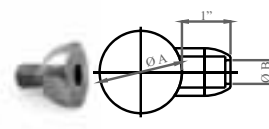
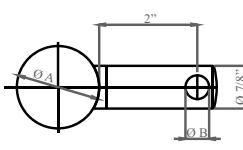
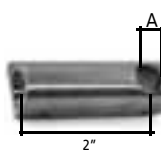
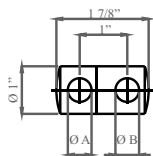
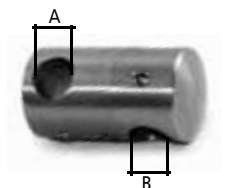

straight - Can be used at 90°

AISI 303	AISI 316	Iron	Hole A	Hole B
E006966	E006966316	I006966	1/2" dia.	1/2" dia.
E006976			9/16" dia.	1/2" dia.
E006977			9/16" dia.	9/16" dia.

AISI 303	For tube	Hole A
E00693	1 2/3" dia.	9/16" dia.

AISI 303	For tube A	Round bar B
E006999	1 2/3" dia.	1/2" dia.
E0069996	1 1/3" dia.	1/2" dia.

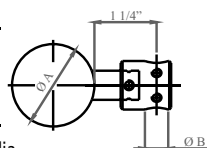
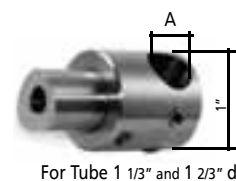

For Tube 1 1/3" and 1 2/3" dia.



Adjustable

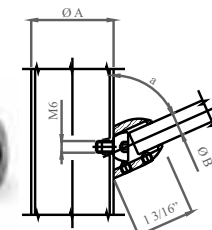

AISI 303	AISI 316	Iron	Hole A	Description
E006	E006316	I006	1/2" dia.	Through
E0066			9/16" dia.	Through

AISI 303	For tube	Round bar A
E0074	1 2/3" dia.	1/2" dia.

AISI 303	For tube A	Round bar B	a°
E0069991	1 2/3" dia.	1/2" dia.	22-33
E0069997	1 1/3" dia.	1/2" dia.	22-33

Adjustable

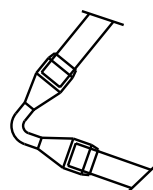
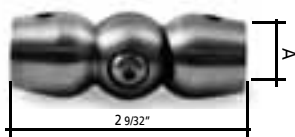

AISI 303	Iron	Round bar A
E0070	I0070	1/2" dia.
E0071		9/16" dia.

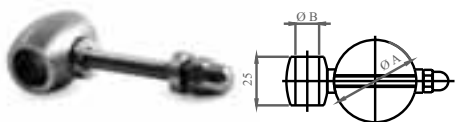

Easy to model

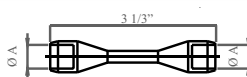

AISI 303	For tube A	Hole B
E00697110	1 1/3" and 1 2/3" dia.	13/32" dia.

AISI 303	AISI 316	Round bar A
E00700	E00700316	13/32" dia.
E00710	E00710316	1/2" dia.



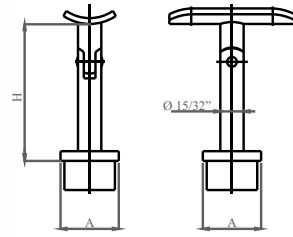
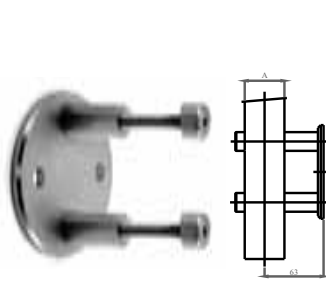
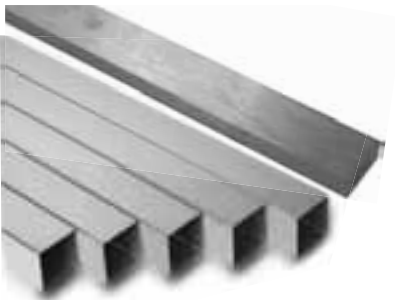

AISI 304	AISI 316	Lenght 9' - 10"	AISI 304	For tube	A	AISI 304	AISI 316	H	For handrail	For square tube	A
E00204040	E10204040 E004720056	1 9/16" x 1 9/16" x 5/64" 9/16" x 3/16" Flat bar	E11440	Flat face		E037200	E037210	2 61/64"	1 2/3" dia.	1 9/16" x 1 9/16" x 5/64"	

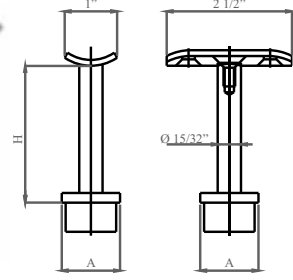
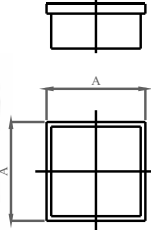
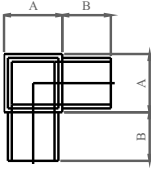

AISI 316	For tube	A	B	AISI 316	For tube	AISI 304	AISI 316	H	For handrail	For square tube	A
E4723	1 9/16" x 1 9/16" x 5/64"	1"		E4230	1 9/16" x 1 9/16" x 5/64"	E037600	E037610	2 61/64"	1 2/3" dia.	1 9/16" x 1 9/16" x 5/64"	

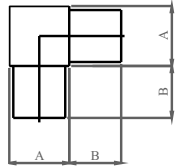
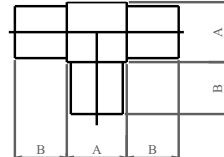
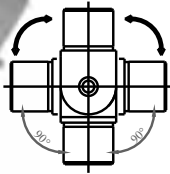

AISI 316	For tube	A	B	AISI 316	For tube	A	B	AISI 316	For tube	A	B
E4743	1 9/16" x 1 9/16" x 5/64"	1"		E4733	1 9/16" x 1 9/16" x 5/64"	1"		E4713	1 9/16" x 1 9/16" x 5/64"	1"	



AISI 316	For tube	
E4760	1 9/16" x 1 9/16" x 5/64"	

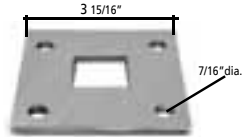

Thickness 15/64"

AISI 304	AISI 316	For tube
E02050	E02050316	1 9/16" x 1 9/16"
		4 9/64" dia.

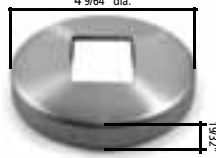

AISI 304	AISI 316	Hole
E02051	E02051316	1 39/64" x 1 39/64"

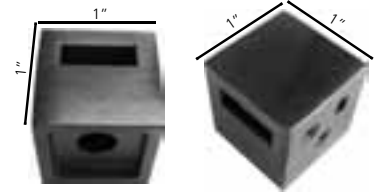

AISI 316	For flat bar
E004720054	9/16" x 3/16"



AISI 316	Hole	Height
E02052316	1 39/64" x 1 39/64"	19/32"



AISI 316	For tube
E4701	1 9/16" x 1 9/16" x 5/64"

CERTIFIED AND TESTED



GLASS CLAMPS

• Glass Clamps

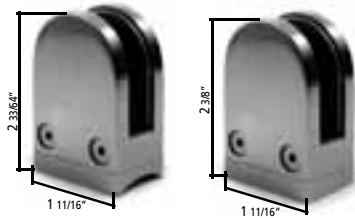

AISI 316	For tube	Glass thickness
E00938	1 1/2" dia.	5/16" and 3/8"
E009	1 2/3" dia.	5/16" and 3/8"
E0090	1 7/8" dia.	5/16" and 3/8"
E0091	Flat face	5/16" and 3/8"

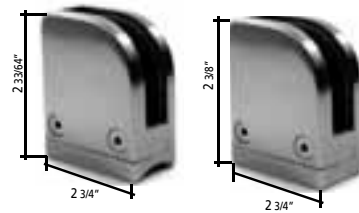

AISI 316	For tube	Glass thickness
E00950	1 2/3" dia.	5/16" and 3/8"
E00951	1 7/8" dia.	5/16" and 3/8"

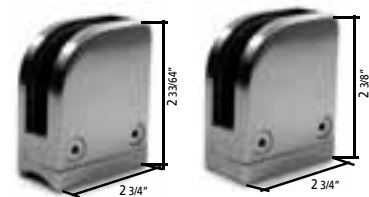
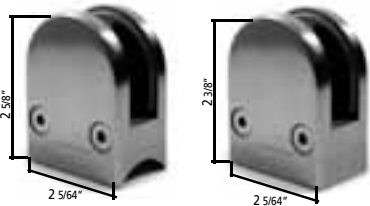

AISI 316	For tube	Glass thickness
E00955	1 2/3" dia.	5/16" and 3/8"
E00956	1 7/8" dia.	5/16" and 3/8"

AISI 316	For tube	Glass thickness
E00971	1 2/3" dia.	1/2"
E00972	1 7/8" dia.	1/2"
E00973	Flat face	1/2"

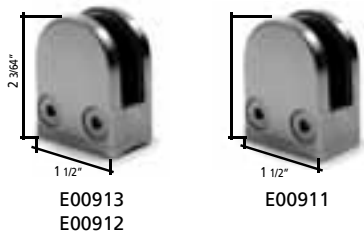

AISI 316	For tube	Glass thickness
E00913	1 1/3" dia.	5/16" and 3/8"
E00912	1 2/3" dia.	5/16" and 3/8"
E00911	Flat face	5/16" and 3/8"

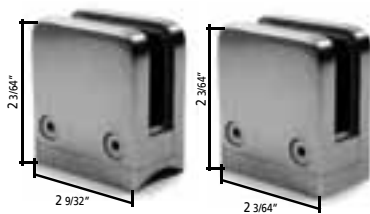

AISI 316	For tube	Glass thickness
E0092	1 2/3" dia.	5/16" and 3/8"
E0093	Flat face	5/16" and 3/8"
E00981	1 2/3" dia.	3/8" and 1/2"
E00983	Flat face	3/8" and 1/2"

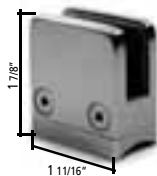

AISI 316	For tube	Glass thickness
E00921	1 2/3" dia.	5/16" and 3/8"



ARTIFERO  
INOX  
SISTEMI AERISSI STEEL ALUMINO SYSTEM

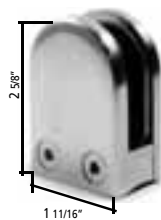

STAINLESS STEEL EFFECT

ZAMAC	For tube	Glass thickness
E00871	1 2/3" dia.	5/16" and 3/8"

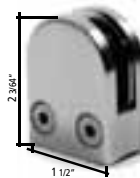

STAINLESS STEEL EFFECT

ZAMAC	For tube	Glass thickness
E00850	1 2/3" dia.	1/4" and 5/16"
E00851	1 1/3" dia.	1/4" and 5/16"

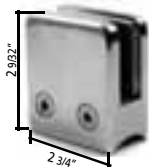

STAINLESS STEEL EFFECT

ZAMAC	For tube	Glass thickness
E00860	1 1/3" dia.	5/16" and 3/8"

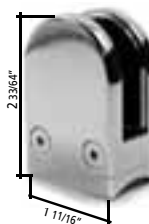

E00730

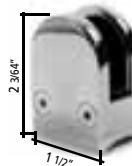

E00731  
E00732

GOLD PLATED

ZAMAC	For tube	Glass thickness
E00730	1 2/3" dia.	5/16" and 3/8"
E00731	1 2/3" dia.	5/16" and 3/8"
E00732	1 1/3" dia.	5/16" and 3/8"

## Glass Clamp for Ground & Wall Anchorage



AISI 303	AISI 316	Glass Thickness
E2000100	E20000200	1/2" and 17/52"



Round support complete with threaded screw and glass attachment.

AISI 304	Glass Thickness
E2200300	From 5/8" to 7/8"

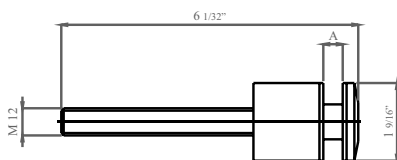

AVAILABLE UPON REQUEST  
ANCHORAGE FLANGE  
E0700 AISI 304 - E0700316 AISI 316



E0700 (AISI 304)  
E0700316 (AISI 316)

3 15/16" dia. x 15/64"

Countersunk holes  
and chamfered perimeter





CERTIFIED AND TESTED  
GLASS CLAMPS



AISI 316	Dimensions	Glass thickness
E00840	2 3/8" dia.	5/16"

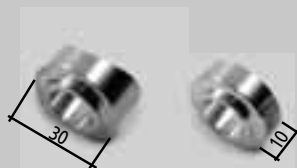

AISI 316 For tube

E00842	1 2/3" dia.
E00843	Flat face
E00845	1 1/2"



No.2 of pieces in set

To use with these article numbers:  
E00820 - E00821 - E00820316 - E00821316 -  
E00830 - E00831 E00830316 - E00831316 -E00840

AISI 316 Description

E00840/C Stainless steel closure satin finished, fundamental to obtain a glass holder for just one glass

Rubber For Glass

E00840/R1	11/32"
E00840/R2	3/8"
E00840/R3	7/16"
E00840/R4	1/2"
E00840/R5	1/2"

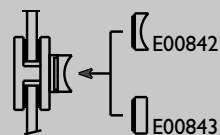

THE INTERCHANGEABLE CLAMP CAN BE USED WITH ALMOST ANY TUBE!



LATERAL LOCKING PERMITS TRANSFORM TO A SINGLE GLASS SUPPORT

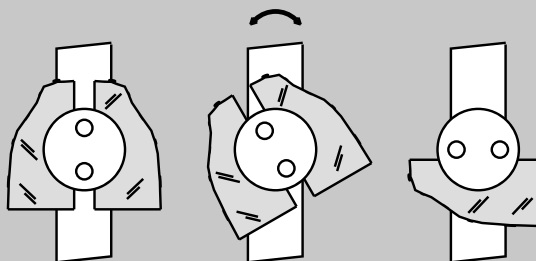

THE MOVABLE CLAMP PERMITS ROTATION OF THE GLASS AROUND A MOUNTED POST

• EASY TO INSTALL • ECONOMICAL • SAFE

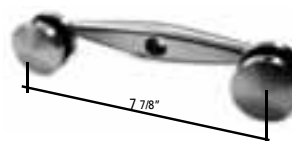

AISI 304 AISI 316 For glass

E00880 E00880316 from 11/32" to 1/2"



AISI 304 AISI 316 For glass

E00881 E00881316 from 11/32" to 1/2"



AISI 316 For tube

E00882316 1 2/3" dia.  
E00883316 Flat face



AISI 316 For tube

E40581 1 2/3" dia.  
E40583 Flat face

AISI 316 Hole

E4032 1/2" dia.



AISI 316 For tube

E40510 1 2/3" dia.



AISI 316 For tube

E40560 1 2/3" dia.  
E40570 Flat face

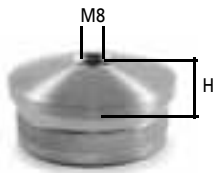

AISI 316	For tube	H
E4130	1 2/3" dia. x 5/64" 9/32"	



AISI 303	Iron	For tube	H
E01111		1 1/3" dia. x 5/64" 21/32"	
E01112	I01112	1 2/3" dia. x 5/64" 3/4"	

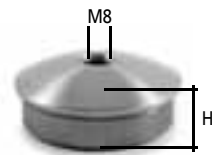

AISI 303	Iron	For tube	H
E01196/38		1 1/2" dia. x 5/64" 9/32"	
E01196	I01196	1 2/3" dia. x 5/64" 9/32"	



AISI 303	Iron	Dimensions
E0117		1 1/3" dia. x 5/64"
E0119/38		1 1/2" dia. x 5/64"
E0119	I0119	1 2/3" dia. x 5/64"
E01190		2" dia.

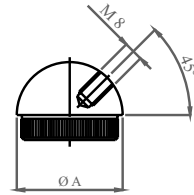

AISI 303	AISI 316	For tube
E01212	E02212	1 2/3" dia. x 5/64"



AISI 303	For tube	H
E0111	1 1/3" dia. x 5/64" 3/4"	
E011	1 2/3" dia. x 5/64" 3/4"	



AISI 303	For tube
E01158	1 2/3" dia. x 5/64"



AISI 303	For tube
E0115	1 1/3" dia. x 5/64"
E0115/38	1 1/2" dia. x 5/64"
E01151	1 2/3" dia. x 5/64"
E01155	2" dia. x 5/64"



AISI 316	For tube	Tube thickness
E316	1 2/3" dia.	1/16" - 3/32"
E315	1 1/3" dia.	1/16" - 3/32"
E4090	1 2/3" dia.	5/64" - 3/32"
E4091	1 7/8" dia.	5/64" - 3/32"



AISI 316	For tube
E4100	1 2/3" dia. x 5/64"



AISI 316	For tube
E4141	1 2/3" dia. x 5/64"



AISI 303	AISI 316	For tube
E0118	E0118316	1/2" dia. x 5/256"



AISI 316	For tube	Dimensions B x A
E481	1 2/3" dia. x 5/64"	3 1/8" x 2 23/64"



AISI 316	For tube
E452	1 2/3" dia. x 5/64"

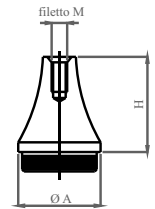

AISI 303	Iron	For tube A	H	Thread M
E0101		1 1/3" dia. x 5/64"	1 3/16"	M8
E010	I010	1 2/3" dia. x 5/64"	1 13/16"	M10



AISI 316	For tube	Dimensions
E461	1 2/3" dia.	2 1/8" dia.
E469	2" dia.	2 33/64" dia.



AISI 316	For tube
E465	1 2/3" dia. x 5/64"
E468	2" dia. x 5/64"

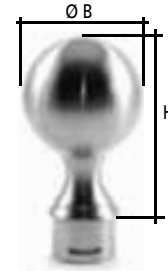

AISI 316	For tube	B	H
E457	1 2/3" dia. x 5/64"	2 3/4" dia.	4 1/6"
E4572	2" dia. x 5/64"	3 5/32" dia.	4 3/4"



AISI 303	Iron	Dimensions	Thread
E012	I012	2 23/64" dia.	M10
E0120		2" dia.	M8

Hole 9/16" dia.

AISI 303	AISI 316	Dimensions
E0128	E4309	1" dia. blind hole
E01281		1" dia. hole
E01301		1 3/16" dia. hole

Hole 1/2" dia.

AISI 303	AISI 316	Iron	Dimensions
E01261			25/32" dia. blind hole
E0127	E4308	I0127	1" dia. blind hole
E0129			1" dia. hole
E0130			1 3/16" dia. hole

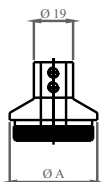

AISI 303	For tube A	Through hole
E01196100	1 2/3" dia. x 5/64"	31/64" dia.

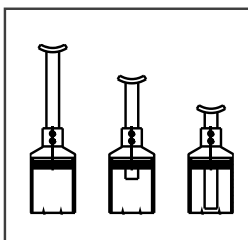



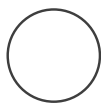

STAINLESS STEEL Newel Posts Partially Pre-assembled in Round Sections



E0696/D

AISI 316	AISI 304	X	H
E00422316	E00422	1 1/3" dia. x 5/64"	47 1/4"
E0042316	E0042	1 2/3" dia. x 5/64"	39 3/8"
E0040316	E0040	1 2/3" dia. x 5/64"	47 1/4"
E0047316	E0047	2" dia. x 5/64"	39 3/8"
E0046316	E0046	2" dia. x 5/64"	47 1/4"
E0042/904316	E0042/904	1 2/3" dia. x 5/64" (Pre-Drilled) with M8 Corner	39 3/8"
E0042/2316	E0042/2	1 2/3" dia. x 5/64" (Pre-Drilled) with 2 Holes, M8	39 3/8"
E0042/4316	E0042/4	1 2/3" dia. x 5/64" (Pre-Drilled) with 4 Holes, M8	39 3/8"
E0042/10316	E0042/10	1 2/3" dia. x 5/64" (Pre-Drilled) with 10 Holes, M5	39 3/8"

Satin finish, with grain size 240, complete with welded flange



E113

AISI 316	AISI 304	X	H
E004501316	E004501	1 1/3" dia. x 5/64"	47 1/4"
E00450316	E00450	1 2/3" dia. x 5/64"	47 1/4"
E00451316	E00451	2" dia. x 5/64"	47 1/4"

Satin finish, with grain size 240, complete with lateral flange



AISI 316 Art. no.	AISI 304 Art. no.	X	H
E00411316	E00411	1 1/3" dia. x 5/64"	47 1/4"
E0043316	E0043	1 2/3" dia. x 5/64"	39 3/8"
E0041316	E0041	1 2/3" dia. x 5/64"	47 1/4"

Satin finish, with grain size 240, complete with flange.

Handrail is angled and extended for maximum security, making it difficult to climb over.



FOR HANDRAILS THAT ARE ANGLED AND EXTENDED FOR MAXIMUM SECURITY

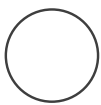

STAINLESS STEEL Newel Posts Partially Pre-assembled in Round Sections

AISI 316	AISI 304	X	H
E0045316	E0045	1 2/3" dia. x 5/64"	47 1/4"
E00452316	E00452	2" dia. x 5/64"	47 1/4"



Satin finish, with grain size 240. Complete with wall mounting plate. Handrail support pivotable, angled and extended for maximum security, making it difficult to climb over.

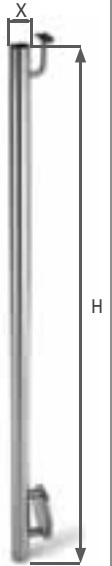

• Round Newel Posts



ARTEFERRO

Stainless Steel Newel Posts Round

AISI 316	AISI 304	Newel post dia.	N° bar holder	bar diameter	Y	H
EM4331209	EM2331209	1 1/3" dia. x 5/64"	9	1/2"	4"	39 3/8"
EM4421009	EM2421009	1 2/3" dia. x 5/64"	9	3/8"	4"	39 3/8"
EM4421209	EM2421209	1 2/3" dia. x 5/64"	9	1/2"	4"	39 3/8"



**NEW**

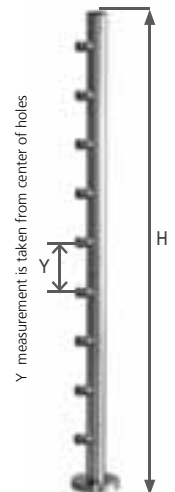

Satin finish, with grain 240, complete with fixed handrail, round bar supports, mounting plate and flange canopy



Ask for our complete catalog  
[www.arteferro.com](http://www.arteferro.com)

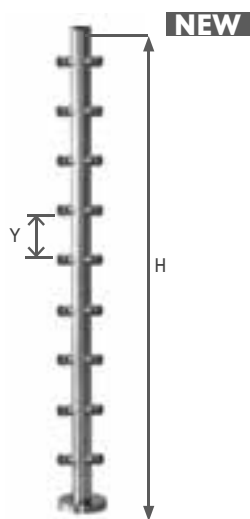
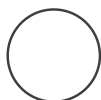

AISI 316	AISI 304	Newel post dia.	N° bar holder	bar diameter	Y	H
EM433120990	EM233120990	1 1/3" dia. x 5/64"	9	1/2"	4"	39 3/8"
EM442100990	EM242100990	1 2/3" dia. x 5/64"	9	3/8"	4"	39 3/8"
EM442120990	EM242120990	1 2/3" dia. x 5/64"	9	1/2"	4"	39 3/8"

Satin finish, with grain 240, complete with fixed handrail support for corners, round bar supports for corners, mounting plate and flange canopy



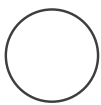

AISI 316	AISI 304	Newel post dia.	N° bar holder	bar diameter	Y	H
EL4331209	EL2331209	1 1/3" dia. x 5/64"	9	1/2"	4"	47 1/4"
EL4421009	EL2421009	1 2/3" dia. x 5/64"	9	3/8"	4"	47 1/4"
EL4421209	EL2421209	1 2/3" dia. x 5/64"	9	1/2"	4"	47 1/4"

Satin finish, with grain 240, complete with fixed handrail support, round bar supports and wall anchor mounting plate



E113

**NEW**

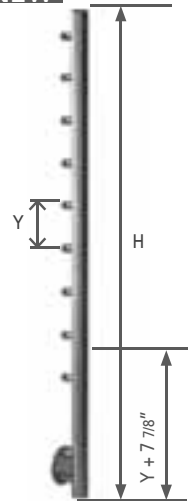

AISI 316	AISI 304	Newel post dia.	bar diameter	Y	Z	H
EK4421209	EK2421209	1 2/3" dia. x 5/64"	1/2"	4"	8 1/4"	39 3/8"

Satin finish, with grain 240, complete with curved tube for fixed handrail support, round bar support and mounting plate



E031/S1

**NEW**

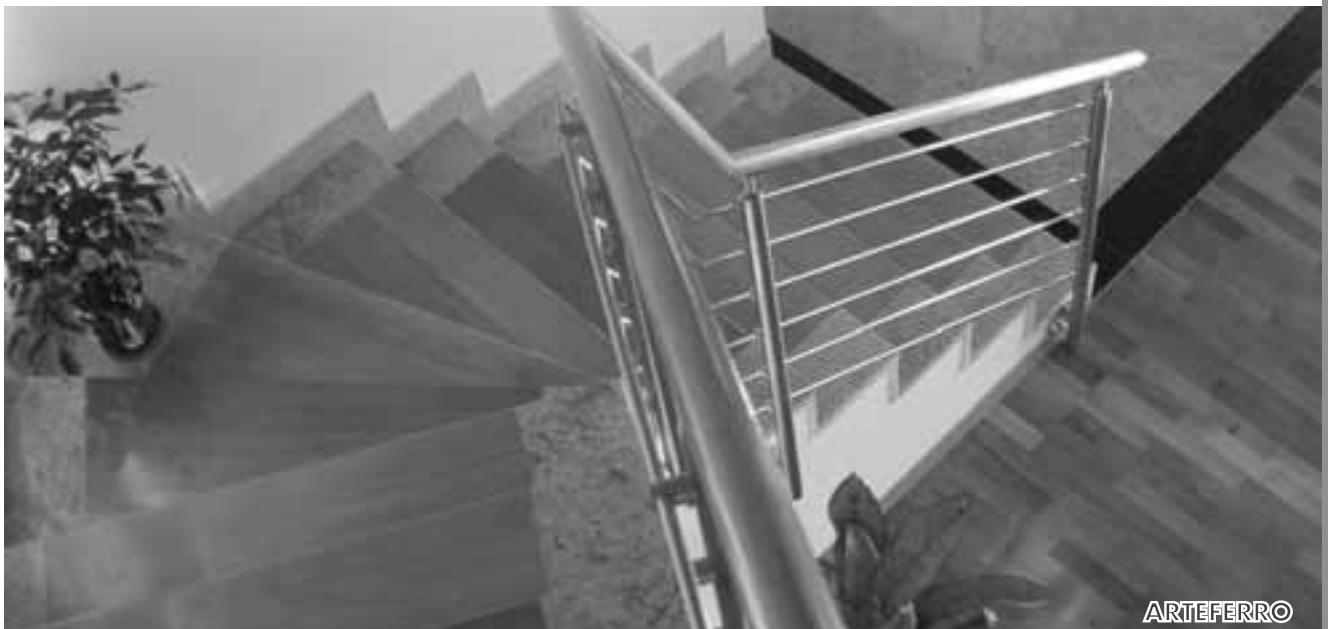
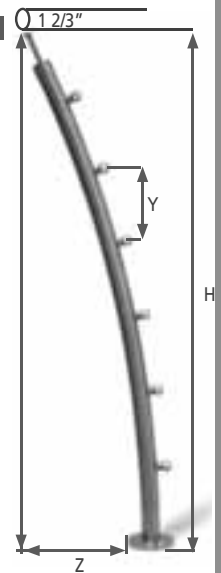

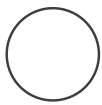

STAINLESS STEEL Newel Posts Partially Pre-assembled in Round Sections

• Round Newel Posts

**NEW**

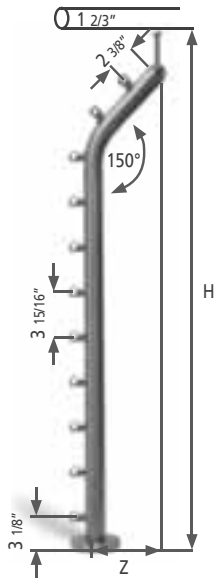

Special Article

AISI 316	AISI 304	Newel post dia.	bar diameter	N° bar holder	Z	H
EW4421211F	EW2421211F	1 2/3" dia. x 5/64"	1/2"	11	9 7/8"	39 3/8"

Satin finish, with grain 240, curved tube, complete with fixed handrail support, 11 round bar support and mounting plate with flange canopy

**NEW**

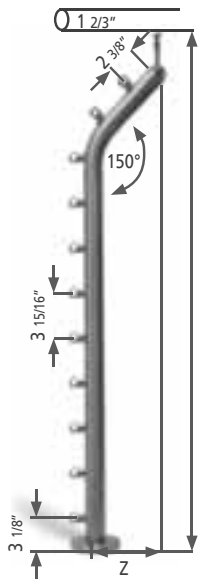

Special Article

AISI 316	AISI 304	Newel post dia.	bar diameter	N° bar holder	Z	H
EW4421211S	EW2421211S	1 2/3" dia. x 5/64"	1/2"	11	9 7/8"	39 3/8"

Satin finish, with grain 240, curved tube, complete with pivotable handrail support, round bar support and mounting plate with flange canopy



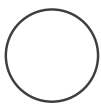

STAINLESS STEEL Newel Posts Partially Pre-assembled in Round Sections

AISI 316	AISI 304	Newel post dia.	Y	H
EP43304P	EP23304P	1 1/3" dia. x 5/64"	25 3/16"	39 3/8"
EP44204P	EP24204P	1 2/3" dia. x 5/64"	25 3/16"	39 3/8"

Satin finish, with grain 240, complete with handrail support, 4 glass clamps with 90° angles, mounting plate and flange canopy

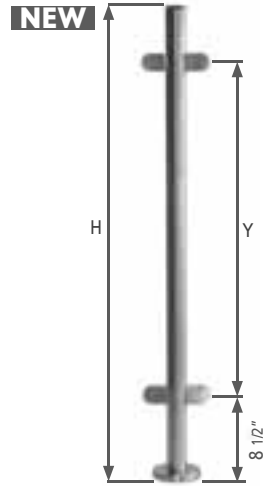

AISI 316	AISI 304	Newel post dia.	Y	H
EP43304P90	EP23304P90	1 1/3" dia. x 5/64"	25 3/16"	39 3/8"
EP44204P90	EP24204P90	1 2/3" dia. x 5/64"	25 3/16"	39 3/8"

Satin finish, with grain 240, complete with handrail support, 4 glass clamps, mounting plate and flange canopy

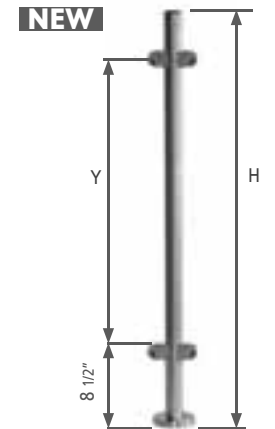

• Round Newel Posts



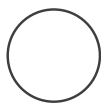

STAINLESS STEEL Newel Posts Partially Pre-assembled in Round Sections

**NEW**

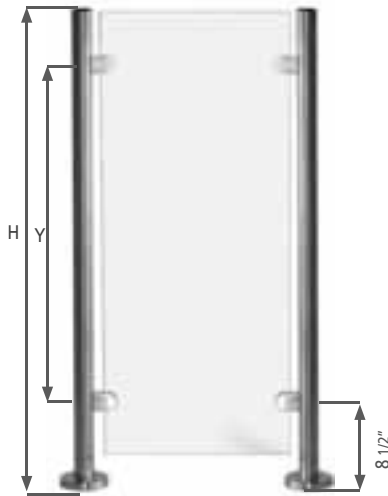

AISI 316	AISI 304	Newel post dia.	Y	H	Pivotable handrail support
EP43302P	EP23302P	1 1/3" dia. x 5/64"	25 3/16"	39 3/8"	No
EP44202P	EP24202P	1 2/3" dia. x 5/64"	25 3/16"	39 3/8"	No

Satin finish, with grain 240, complete with handrail support, 2 glass clamps, mounting plate and flange canopy

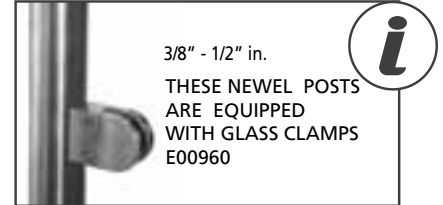

**NEW**

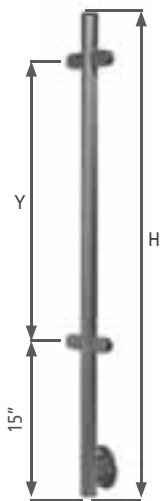

AISI 316	AISI 304	Newel post dia.	Y	H	Pivotable handrail support
ER43304P	ER23304P	1 1/3" dia. x 5/64"	25 3/16"	47 1/4"	No
ER44204P	ER24204P	1 2/3" dia. x 5/64"	25 3/16"	47 1/4"	No

Satin finish, with grain 240, complete with handrail support, 4 glass clamps, mounting plate and wall mounting plate

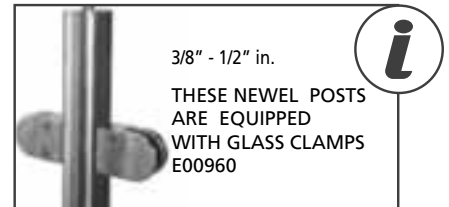

**NEW**

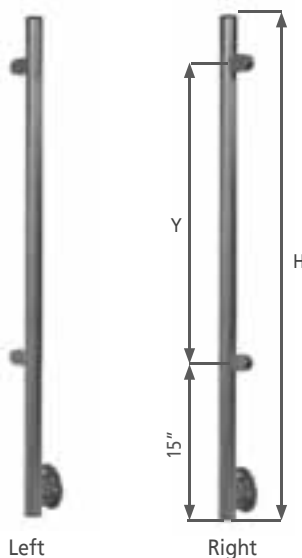

	AISI 316	AISI 304	Newel post dia.	Y	H	Pivotable handrail support
Right	ER43302PDX	ER23302PDX	1 1/3" dia. x 5/64"	25 3/16"	47 1/4"	No
	ER44202PDX	ER24202PDX	1 2/3" dia. x 5/64"	25 3/16"	47 1/4"	No

	AISI 316	AISI 304	Newel post dia.	Y	H	Pivotable handrail support
Left	ER43302PSX	ER23302PSX	1 1/3" dia. x 5/64"	25 3/16"	47 1/4"	No
	ER44202PSX	ER24202PSX	1 2/3" dia. x 5/64"	25 3/16"	47 1/4"	No

Satin finish, with grain 240, complete with handrail support, 2 glass clamps, mounting plate and wall mounting plate

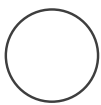

Iron	X	B	H
I00422	1 1/3" dia. x 5/64"	3 15/16" x 15/64"	47 1/4"
I0042	1 2/3" dia. x 5/64"	3 15/16" x 15/64"	39 3/8"
I0040	1 2/3" dia. x 5/64"	3 15/16" x 15/64"	47 1/4"

**i** UPON REQUEST, WE CAN PRODUCE OUR COMPONENTS IN YOUR CHOICE OF COLORS

Galvanized iron that can be painted, complete with mounting plate

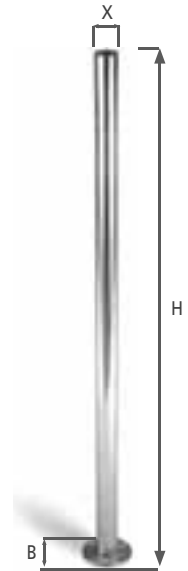

Iron	X	B	H
I00441	1 1/3" dia. x 5/64"	3 15/16" x 15/64"	47 1/4"
I0043	1 2/3" dia. x 5/64"	3 15/16" x 15/64"	39 3/8"
I0041	1 2/3" dia. x 5/64"	3 15/16" x 15/64"	47 1/4"

**i** UPON REQUEST, WE CAN PRODUCE OUR COMPONENTS IN YOUR CHOICE OF COLORS

Galvanized iron that can be painted, complete with mounting plate

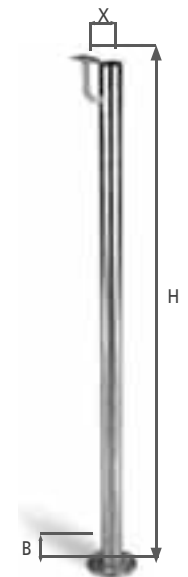

Iron	X	H
I00451	1 1/3" dia. x 5/64"	47 1/4"
I00450	1 2/3" dia. x 5/64"	47 1/4"

**i** UPON REQUEST, WE CAN PRODUCE OUR COMPONENTS IN YOUR CHOICE OF COLORS

Galvanized iron that can be painted, complete with mounting plate

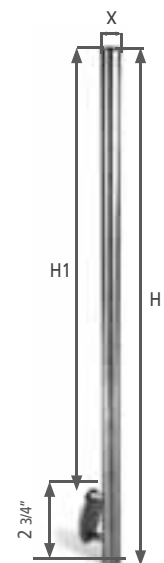



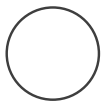

GALVANIZED STEEL Newel Posts

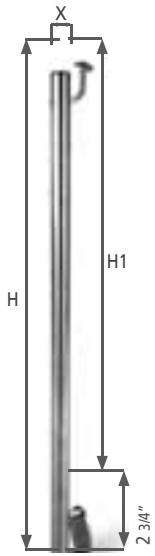

I113

Iron	X	H
I0045	1 2/3" dia. x 5/64"	47 1/4"

Galvanized iron that can be painted, complete with wall mounting plate. Handrail support is pivotable, angled and extended for maximum security, making it difficult to climb over.



UPON REQUEST, WE CAN PRODUCE OUR COMPONENTS IN YOUR CHOICE OF COLORS







STAINLESS STEEL Newel Posts in Square Sections

AISI 316	AISI 304	Dimensions	N° bar holder	bar dia.	H
EQ4301209	EQ2301209	1 3/16" x 1 3/16" sq.	9	1/2"	39 3/8"
EQ4401209	EQ2401209	1 9/16" x 1 9/16" sq.	9	1/2"	39 3/8"

Satin finish, with grain size 240, complete with pivotable handrail support, round bar supports and anchor plate

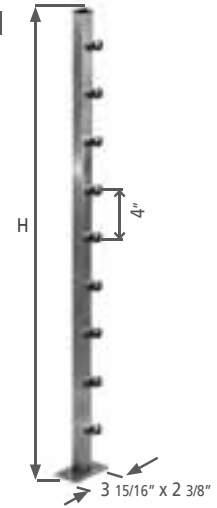

**NEW**



AISI 316	AISI 304	Dimensions	Y	H
EQ43002P	EQ23002P	1 1/3" dia. x 5/64"	25 3/16"	39 3/8"
EQ44002P	EQ24002P	1 2/3" dia. x 5/64"	25 3/16"	39 3/8"



3/8" - 1/2" in.

**THESE NEWEL POSTS ARE EQUIPPED WITH GLASS CLAMPS E00983**



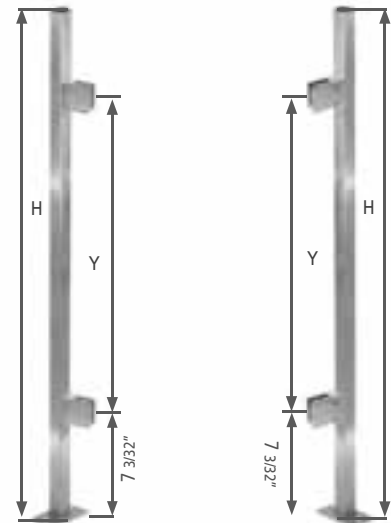

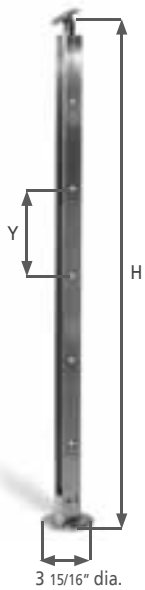

AISI 316	AISI 304	N° holes for assembling of cross bar holdfers	Y	H
E00669316	E00669	8	4"	37 15/16"

Satin finish grain size 240: plated, drilled and countersunk bars for round bar supports complete with pivotable handrail support and anchor plate

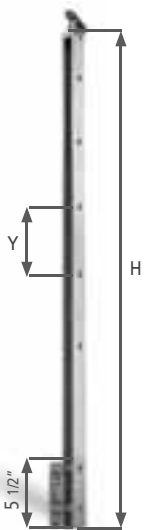

AISI 316	AISI 304	N° holes for assembling of cross bar holders	Y	H
E00559316	E00559	8	4"	47"

Satin finish with grain size 240, complete with fixed handrail support, round bar supports, anchor plate

Round Bar Supports for Double Plates Newel Post



AISI 316	AISI 304	Hole
E01316	E01	5/16" dia.
E02316	E02	13/32" dia.
E03316	E03	1/2" dia.
E04316	E04	9/16" dia.
E05316	E05	Without hole

In stainless steel, satin finish with grain size 240 and n° 2 assembly screws

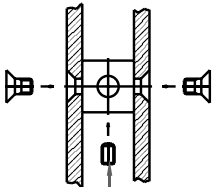

**TO BE USE WITH THESE COMPONENTS**

E00668 - E00669 - E01668 - E01669 - E00668316 - E00669316  
 E01668316 - E01669316  
 E00558 - E00559 - E01558 - E01559 - E00558316 - E00559316  
 E01558316 - E01559316

**i**



AISI 316	AISI 304	N° round bar supports	For bar diameter	X	Y	H
E000463316	E000463	9	3/8" dia.	5 1/2"	3 15/16"	43 1/4"
E000465316	E000465	9	1/2" dia.	5 1/2"	3 15/16"	43 1/4"

Satin finish, grain size 240 complete with pivotable handrail support, pivotable anchor base



E021330

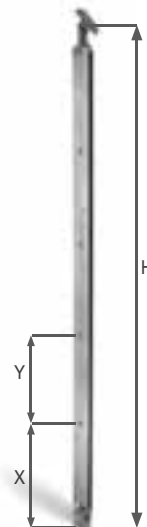

THE ROUND BARS COME PRESSURE BLOCKED BETWEEN TWO STEEL PLATE



TO BE COMBINED WITH SCREW FLANGE E016, FLANGE CANOPY E0192 AND SCREW E032



ARTEFERRO



ARTEFERRO

• Double Plates Newel Posts

Custom Order Newel Posts

STAINLESS STEEL		AISI 304	AISI 316
SATIN FINISH	<input type="checkbox"/>	<input type="checkbox"/>	
POLISHED	<input type="checkbox"/>	<input type="checkbox"/>	
IRON			
RAW, UNFINISHED		<input type="checkbox"/>	
GALVANIZED		<input type="checkbox"/>	
GALVANIZED AND PAINTED		<input type="checkbox"/>	
color		_____	

QUOTE	<input type="checkbox"/>
ORDER	<input type="checkbox"/>

TECHNICAL DRAWING WITH QUOTE

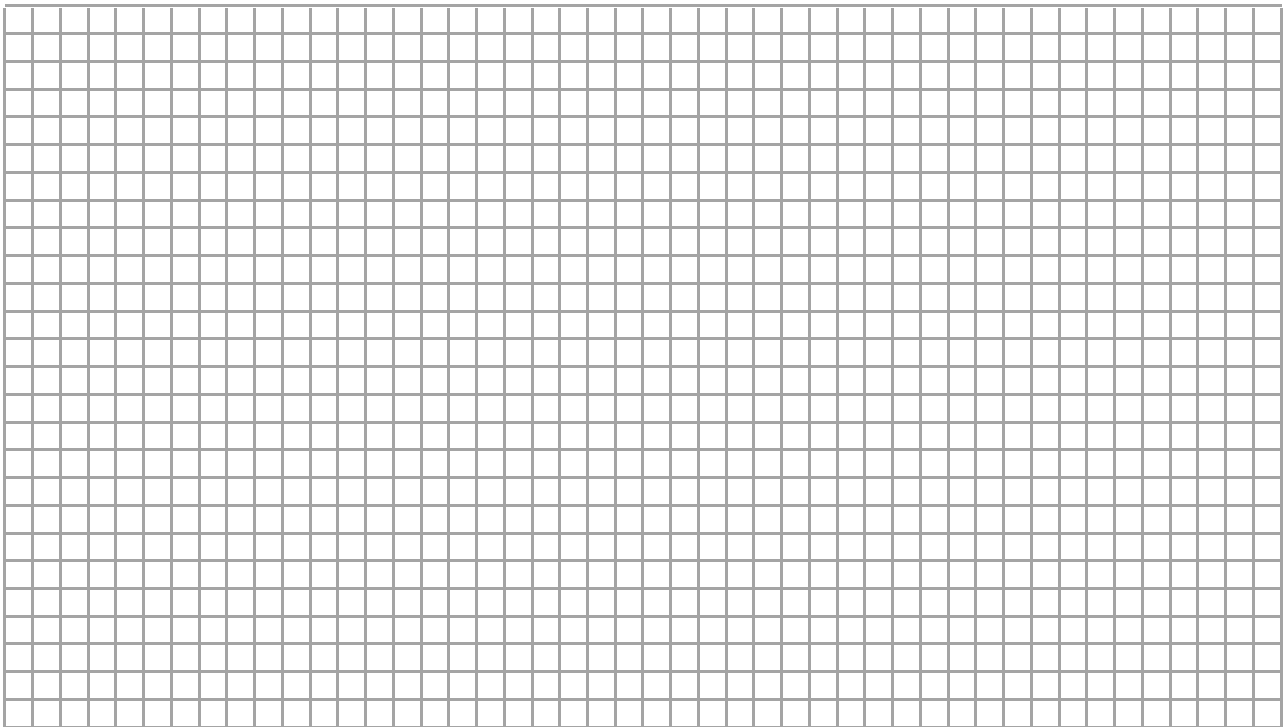

NOTES:

Name	Telephone
Company	Fax
Street, nr.	E-mail
City, State, Zip Code	



AISI 316	AISI 304	Tube
E1100424	E1000424	1 2/3" dia. x 1/16" x 19' - 8"
E1100483	E1000483	1 7/8" dia. x 5/64" x 19' - 8"

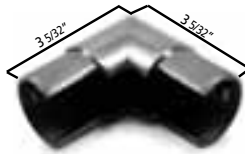

AISI 316	Tube
E1500100	1 2/3" dia. x 1/16"
E1500110	1 7/8" dia. x 5/64"

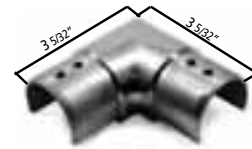

AISI 316	Tube
E1400100	1 2/3" dia. x 1/16"
E1400110	1 7/8" dia. x 5/64"



AISI 316	Profile
E1100000	1" x 1" x 1/16" x 9' - 10"



AISI 316	Tube
E1300100	1 2/3" dia. x 1/16"
E1300110	1 7/8" dia. x 5/64"

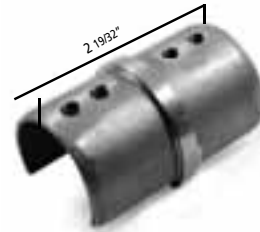

AISI 316	Tube
E1200100	1 2/3" dia. x 1/16"
E1200110	1 7/8" dia. x 5/64"



Also available in groups of 19' 8"



Rubber	Tube	Glass	Coil length
E1999100	1 2/3" dia.	5/16" - 7/16"	100'
E1999200	1 2/3" dia.	1/2" - 5/8"	100'
E1999300	1 2/3" dia.	5/8" - 11/16"	100'
E1999400	1 7/8" dia.	5/16" - 33/64"	100'
E1999500	1 7/8" dia.	9/16" - 11/16"	100'
E1999650	1 7/8" dia.	11/16" - 7/8"	100'

AISI 316	Tube
E1100100	1 2/3" dia. x 1/16"
E1100110	1 7/8" dia. x 5/64"





# GLASS U



REVOLUTIONARY SYSTEM  
FOR GLASS RAILING  
TESTED AND CERTIFIED AT 200 Kg/ml

CERTIFICATION AND TESTED REPORT AVAILABLE AT  
[WWW.ARTEFERROINOX.COM](http://WWW.ARTEFERROINOX.COM)

## Floor Fixing Channel End Accessories

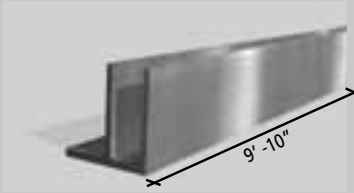

ALUMINIUM	Description
E1600100	Aluminium support for floor anchorage

ALUMINIUM	Art. no.
	E1600500

ALUMINIUM	Art. no.
	E1600600

ALUMINIUM	Art. no.
	E1600700

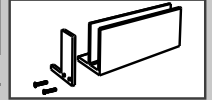

## Wall Fixing Channel End Accessories

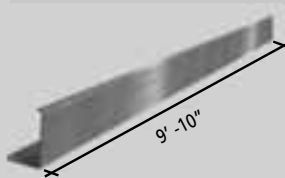
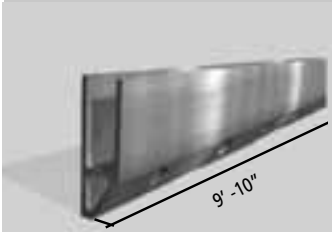

ALUMINIUM	Description
E1700200	Aluminium support for wall anchorage

ALUMINIUM	Description
E1700300	Carter to cover the holes of E1700200

ALUMINIUM	Art. no.
	E1700500

ALUMINIUM	Art. no.
	E1700600

ALUMINIUM	Art. no.
	E1700700

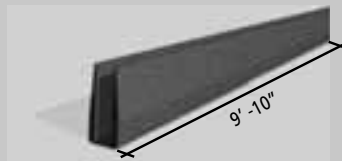
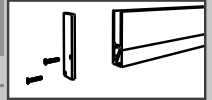

Rubber	Description	Rubber	Description	Glass thickness	Rubber	Description	Glass thickness
E1999830	Fixing wedge made of synthetic material	E1999800	Gaskets for art. E1600100 and E1700200	5/16" and 7/16"	E1999850	Closing Gaskets	5/16" and 7/16"
		E1999810	Gaskets for art. E1600100 and E1700200	13/16" and 7/8"	E1999860	Closing Gaskets	13/16" and 7/8"

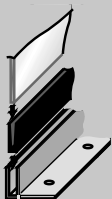

INSERT THE GLASS IN THE CLOSING DEVICE AND LAY EVERYTHING IN THE ALUMINIUM PROFILE

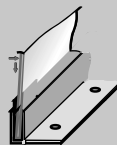

MOVE THE GLASS ON ONE SIDE AND INSERT WEDGES IN THE OPPOSITE SIDE OF THE GLASS

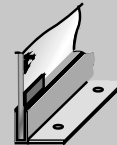

AFFIX THE GLASS BY PUTTING WEDGES IN THE OTHER SIDE OF THE GLASS APPLYING A SLIGHT PRESSURE





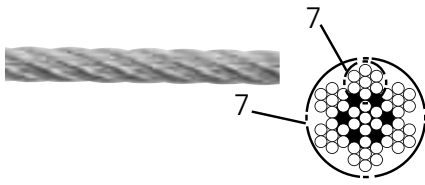

AISI 316	Rope	Min. Brake load
EF7X704	5/32" dia.	9,00 kN
EF7X705	13/64" dia.	14,00 kN
EF7X706	15/64" dia.	20,00 kN



AISI 316		Rope	Y
left	right		
ETM05SX	ETM05DX	13/64" dia.	2 23/64"
ETM06SX	ETM06DX	15/64" dia.	2 3/4"



AISI 316	Description
ET06	Domed head nut right hand thread M6

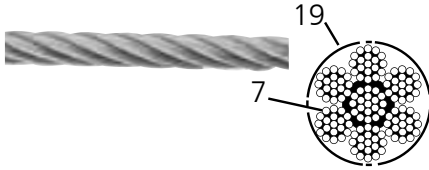

AISI 316	Rope	Min. Brake load
EF7X1904	5/32" dia. / 4mm	8,50 kN
EF7X1905	13/64" dia. / 5mm	14,00 kN
EF7X1906	15/64" dia. / 6mm	20,00 kN



AISI 303	AISI 316	Description
ED05	ED05316	Adjustable ropes with 2 M6 thread

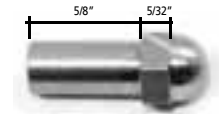

AISI 316	Description
ED06	Domed head nut right hand thread M6
ED06SX	Domed head nut left hand thread M6

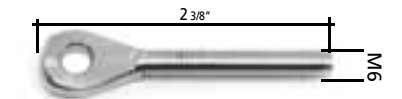
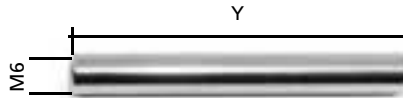

AISI 316	Description
ED07	Rounded head screw M6 thread right

AISI 316		Rope	Y
right	left		
ETF05DX	ETF05SX	13/64" dia.	2 23/64"
ETF06DX	ETF06SX	15/64" dia.	2 3/4"

AISI 316	Description
ETF06DX	Right hand thread
ETF06SX	Left hand thread

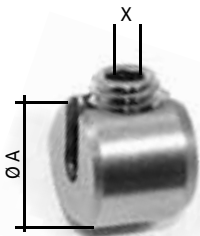

AISI 303	Rope	X	A
EA05	13/64" - 15/64" dia.	M10	25/32" dia.

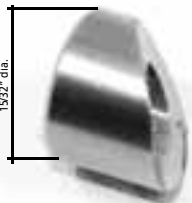

AISI 303	AISI 316	For tube	Hole
EB061	EB061316	1 2/3" dia.	17/64" dia.
EB063	EB063316	Flat face	17/64" dia.





EXAMPLE OF APPLICATION

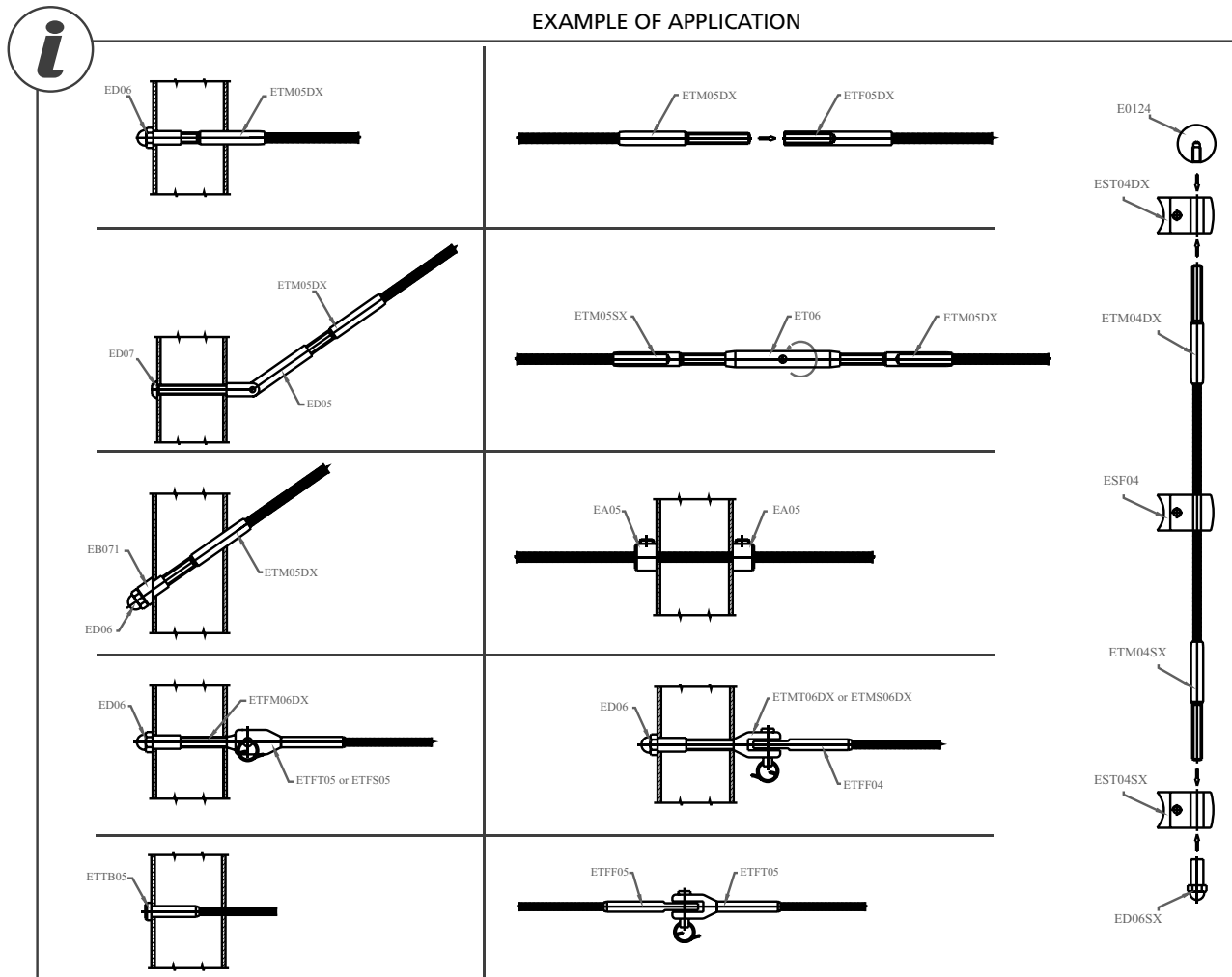

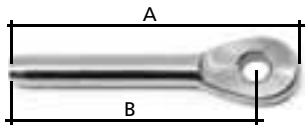

AISI 316	Rope	A	B
ETFF05	13/64" dia.	2 7/8"	1 7/8"
ETFF06	15/64" dia.	3 15/32"	2 61/64"

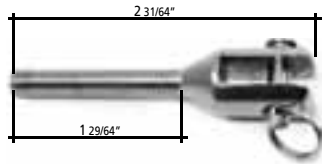

AISI 316	Description
ETMT06DX	Right hand thread
ETMT06SX	Left hand thread

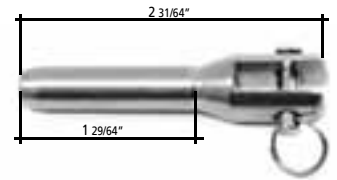

AISI 316	Rope
ETFT05	13/64" dia.

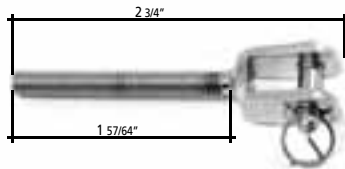

AISI 304	Description
ETMS06DX	Right hand thread
ETMS06SX	Left hand thread

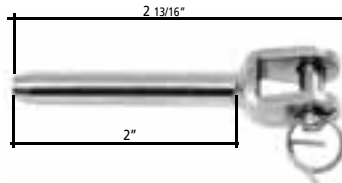

AISI 304	Rope
ETFS06	15/64" dia.



AISI 316	Rope	Thread	A
ETSM10	13/64" dia.	M6-M10	4 11/64"

How to Construct Article Numbers: ETSM8, ETSM10 e ETSM12: Use of the Crimping Tool is Not Necessary



INSERT THE CABLE ON THE INSIDE OF THE POINT OF ARTICLE: ETSM8



UNROLL THE CABLE AND INSERT THE NOSE OF THE CENTRAL PART OF THE CABLE

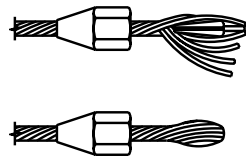

ROLL AROUND TO FORM ONE PIECE AND INSERT CABLE ON THE INSIDE OF THE POINT OF ARTICLE: ETSM8



SCREW IN THE FINAL PART OF ARTICLE: ETSM8

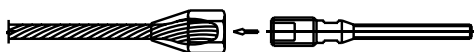

BLOCK WITH THE ENCLOSED NUT

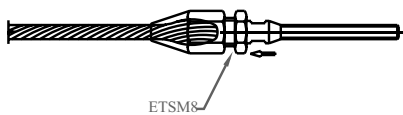

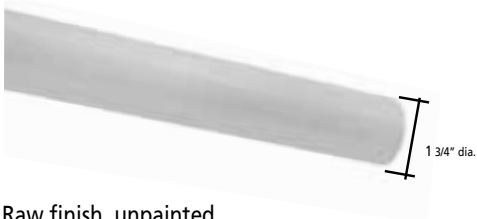

Raw finish, unpainted

Wood	Description
E690/G	Wooden handrail 6'5" ft long
E690/3000/G	Wooden handrail 10 ft long



AISI 304	Description
E603	Wooden handrail connector 1 3/4" dia.



AISI 304	Description
E601	90° angle



AISI 304	Description
E4260	Rounded end terminal



AISI 304	Hole Diameter
E6080	1 3/4" dia.



Color: Beech

Wood	Description
E690	Wooden handrail 6'5" ft long
E690/3000	Wooden handrail 10 ft long



AISI 304	Description
E602	"T" fitting wooden handrail 1 3/4" dia.



AISI 304	Description
E604	Articulated angle



AISI 304	Description
E4265	Flat end terminal

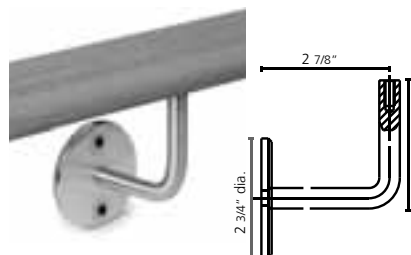

AISI 304	Description
E0224	Handrail support



Color: Wengé a large, straight tree of Central and West Africa, valued for its hard dark wood

Wood	Description
E692	Wooden handrail 6'5" ft long
E692/3000	Wooden handrail 10 ft long



AISI 304	Description
E600	90° curved



AISI 304	Description
E605	Pivotable connector

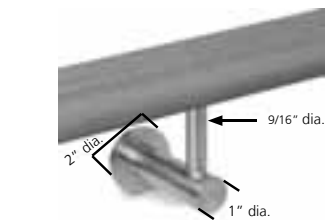

AISI 304	Description
E4586	Handrail support 1 9/16" dia. / 1 57/64" dia. and square

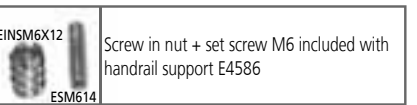



Plastic	Description
---------	-------------

E600/T Plastic supports for end caps and fittings (screw included)



Aluminium	Description
-----------	-------------

E600/D Drill-gauge for wooden handrails



Iron	Description
------	-------------

E600/D1 Drilling template for radial holes in wooden handrails 1 3/4" dia.

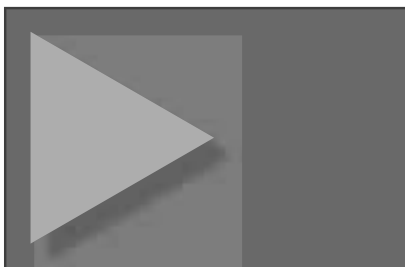
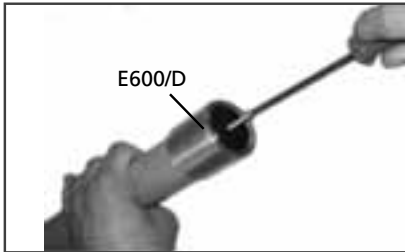

Hexagon socket countersunk flat head screw  
UNI 5933 / DIN 7991



AISI 316	AISI 304	Iron	Thread
E0385316	E0385	I0385	M5 x 1"
	E0322		M6 x 3/8"
	E03851		M6 x 63/64"
	E0321		M8 x 25/32"
	E032		M10 x 1"
	E0325		M5 x 25/64"
	E036		M6 x 1 3/16"

Hexagon socket head cap screw  
UNI 5931 / DIN 912 / ISO 4762



AISI 304	Thread
E0323	M8 x 25/32"

Hexagon socket set screw UNI 5923 / DIN 913 / ISO 4026



AISI 316	AISI 304	Iron	Thread
E0386316	E0386		M8 x 1 3/16"
E0330316	E0330	I0330	M10 x 1 3/16"
	E0330/S		M5 x 1/4"

Hexagon socket set screw UNI 5927 / DIN 914 / ISO 4027



AISI 304	Thread
E0351	M4 x 13/64"
E035	M5 x 13/64"

Cross recessed countersunk flat head screw  
(for sheet) UNI 6555 / DIN 7982 / ISO 7050



AISI 316	AISI 304	Thread
E0383316	E0383	7/32" x 55/64"
	E0384	1/4" x 55/64"

Cross recessed countersunk  
flat head screw (for wood) DIN 7505A



AISI 304	Iron	Thread
E0382	I0382	13/64" x 25/32"
E0381		15/64" x 25/32"

Stainless steel

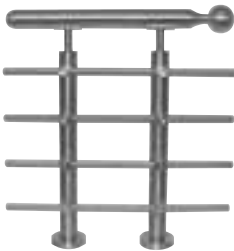

AISI 304

1432/1

Dimensions  
19 11/16" x 21 21/32"



Threaded inserts for riveting tool

AISI 304	Iron	Thread
E40591	I40591	M5
E40592		M6
E40593		M8



Mandrels for riveting tool

E40590M5	Thread
E40590M6	M5
E40590M8	M6
	M8

Stainless steel and wood

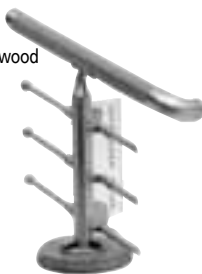

AISI 304

E/PAN13

Dimensions  
19 11/16" x 21 21/32"

Stainless steel

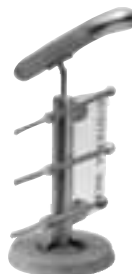

AISI 304

Iron

E/PAN14

I/PAN14

Dimensions  
19 11/16" x 21 21/32"

Drilling template, patented for tubes dia. 1 1/3" - 1 2/3" - 1 7/8"  
Tool for drilling radial holes dia. 9/32" - 11/32" - 7/16"  
For threaded inserts and holes of M5 - M6 - M8 threadings

Art. no.  
E40580

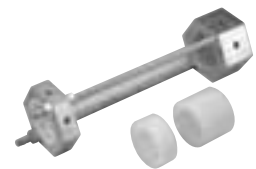

Plastic box containing tool, with M5, M6, M8 mandrels and heads. Riveting tool for threaded inserts M5, M6, M8.

E40590



Degreaser spray  
Spray for cleaning all metal surfaces to be glued.

E4051



De-rusting solution for stainless steel. It is a powerful degreasing product to clean up the iron traces from the stainless steel surfaces. It cleans, protects and exalts the pre-existing brightness.

Leaves a thin antistatic and water-repellent coat on the treated metallic surfaces. It is recommended on finished products.

E4052



Passivating paste for stainless steel. Its purpose is to create a protective oxide and chrome film on the stainless steel surface.

Threadlocking

E4053



E4052/D  
Product enough for approx 16'5"



E4052/P  
Product enough for approx 16'5"



High gluing adhesive

E4054



Electric crimping tool



Generated power 50 kN

Portable oil-dynamic battery tool with pivotable head for pressing wire ropes.

Kit composed by:  
-basic tool with battery, wrist strap and shoulder strap;  
-spare battery;  
-battery charger

E40680

Shearing tool for wire ropes till 5/16" dia.



E40690

Manual crimping tool; Hydraulic crimping tool for pressing the terminal support for wire ropes



E40685

Generated power 50 kN

## How to treat oxidized stainless steel

Stainless steel is a lasting and reliable material. Nevertheless, it is necessary to treat it correctly in order to avoid its oxidization under specific circumstances. As a matter of fact, stainless steel can oxidize in case of: storage near Iron elements, inadequate treatments during the assembling phase, use of the same tools used to work Iron elements, urban pollution and dust, proximity of companies working in the metallurgic field.

In order to meet the needs of its customers, Ind.I.A. SpA created a line of specific items: the De-rusting (item E4052/D) and the Passivating (item E4052/P) products. Such line includes some de-rusting items aimed at cleaning "polluted" stainless steel components as well as some passivating products in order to restore their protective film. The combined use of such products allows the "renovation" even of surfaces that apparently seem compromised.



Example of a stainless steel picket polluted by external agents like dust and smog



Application of the de-rusting product E4052/D: all polluted parts must be covered



Application of the passivating product E4052/P: the polluted component must entirely be covered



Result of the application of Ind.I.A. SpA's de-rusting and passivating products

# INOX INSTALLATION VIDEOS



Step by step instructions for  
BARS, GLASS, & CABLE systems

INOX Schematics offer a visual template for standard parts used in each system; bars, glass, cable, and Woodinox. Please reference the INOX installation videos in the DOWNLOAD section for assistance and training.

Home > Downloads > Multimedia

## MULTIMEDIA

**DISCLAIMER:** Installation videos for the various INOX stainless steel railing systems were shot in Europe. Code requirements by local municipalities within the United States market(s) will vary. Please check with your local building codes for proper dimensional, continuation, and spacing requirements.

<a href="#">Download &gt;&gt;</a>	<a href="#">Download &gt;&gt;</a>	<a href="#">Download &gt;&gt;</a>	<a href="#">Download &gt;&gt;</a>
<b>INOX - Bar System</b> Instructional step by step video for installing the INOX Stainless Steel Handrail with Round Bars.	<b>INOX - Cable System</b> Instructional step by step video for installing the INOX Stainless Steel Cable Railing Systems.	<b>INOX - Flat Handrail with Bars System</b> Instructional step by step video for installing the INOX Stainless Steel Handrail with Flat Handrails with Bars.	<b>INOX - Glass System</b> Instructional step by step video for installing the INOX Stainless Steel Handrail with Glass.
<a href="#">Download &gt;&gt;</a>	<a href="#">Download &gt;&gt;</a>	<a href="#">Download &gt;&gt;</a>	<a href="#">Download &gt;&gt;</a>
<b>INOX Anchorage</b>	<b>INOX Cable / Rope</b>	<b>INOX End Cap</b>	<b>INOX Glass Clamps</b>



## HORIZONTAL ROUND BAR SYSTEM

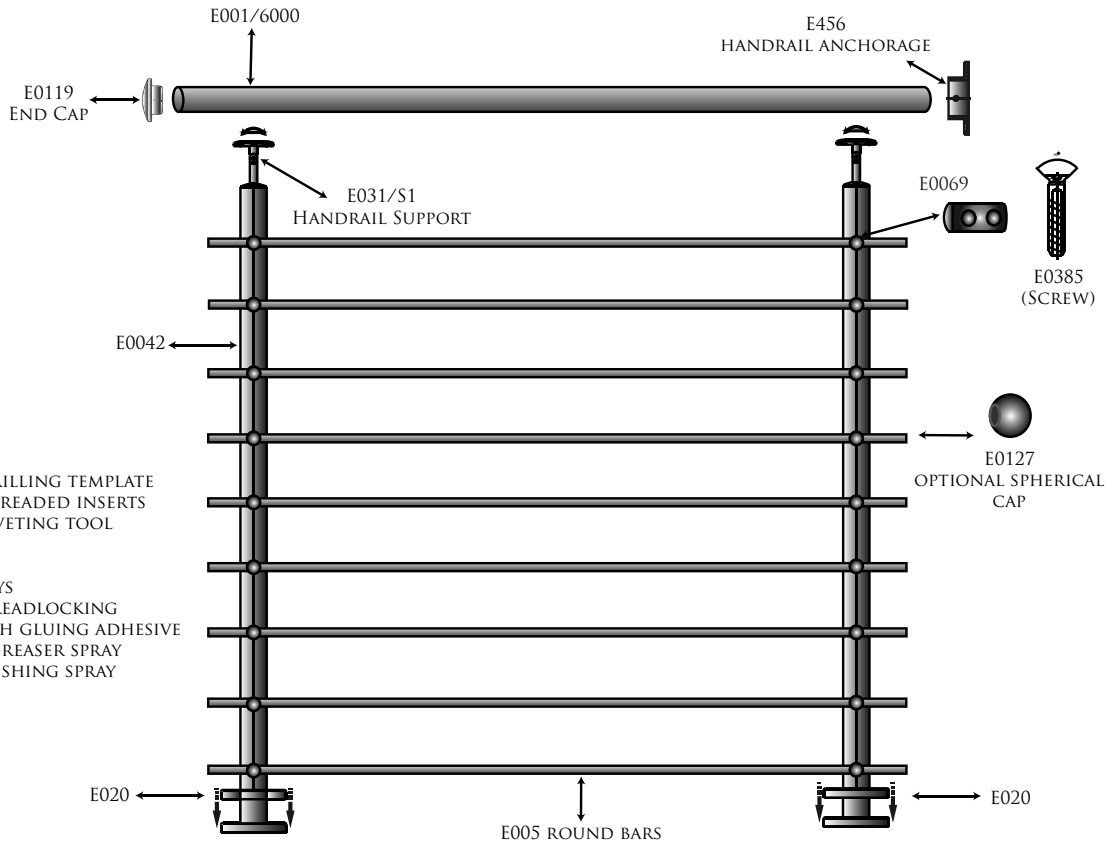

## HORIZONTAL GLASS SYSTEM

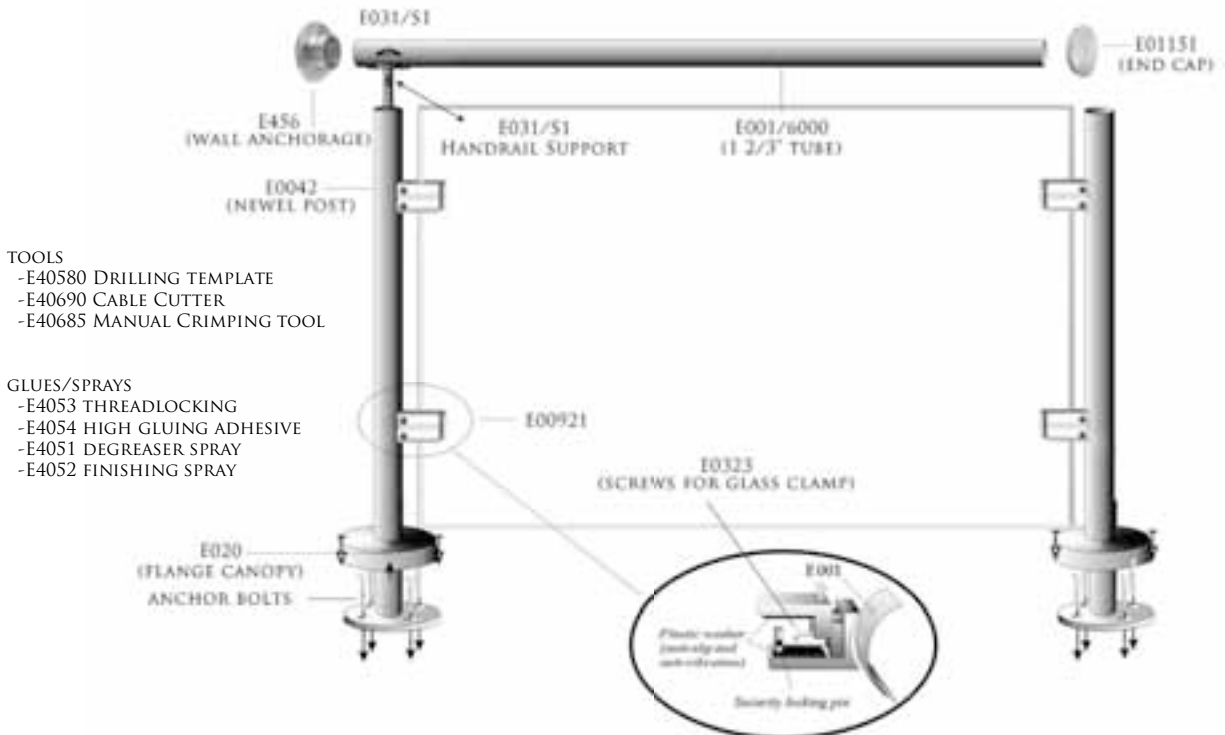

## WALL MOUNT ROUND BAR RAKE SYSTEM

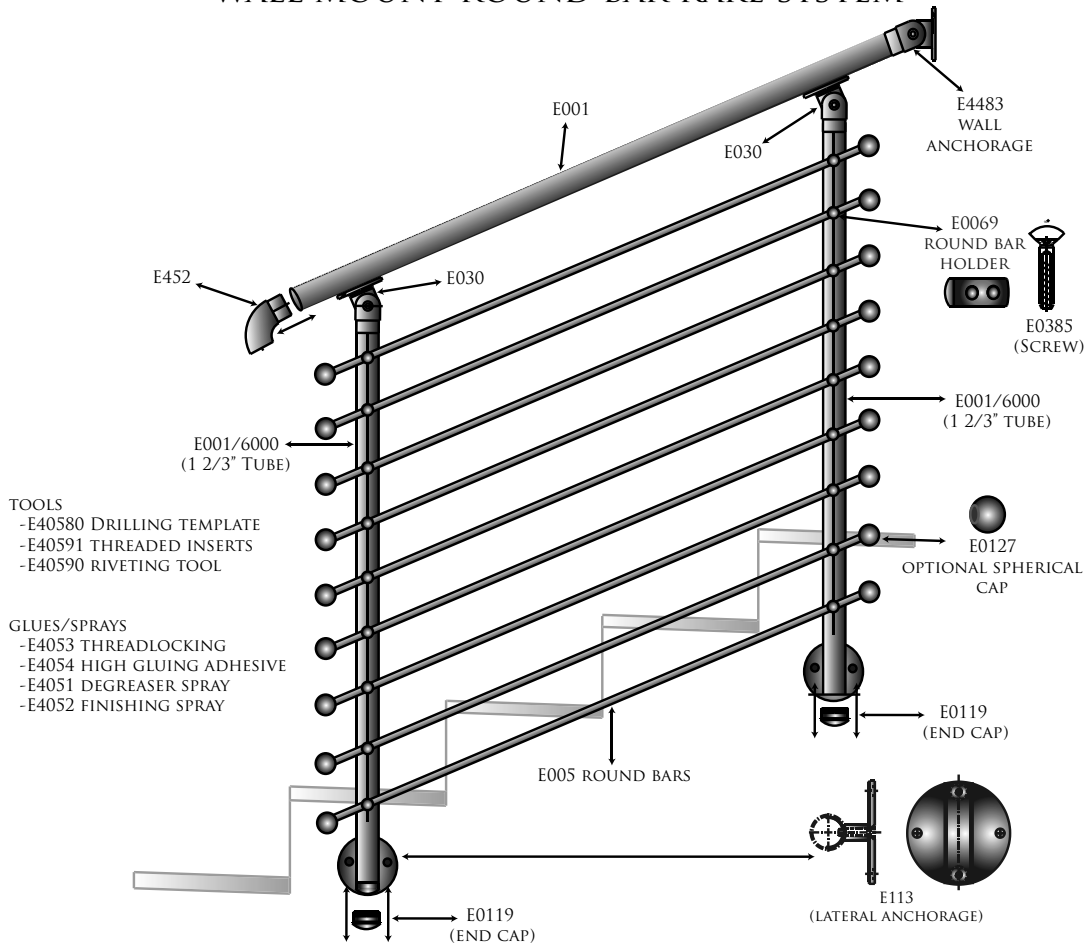

## WALL MOUNT CABLE RAKE SYSTEM

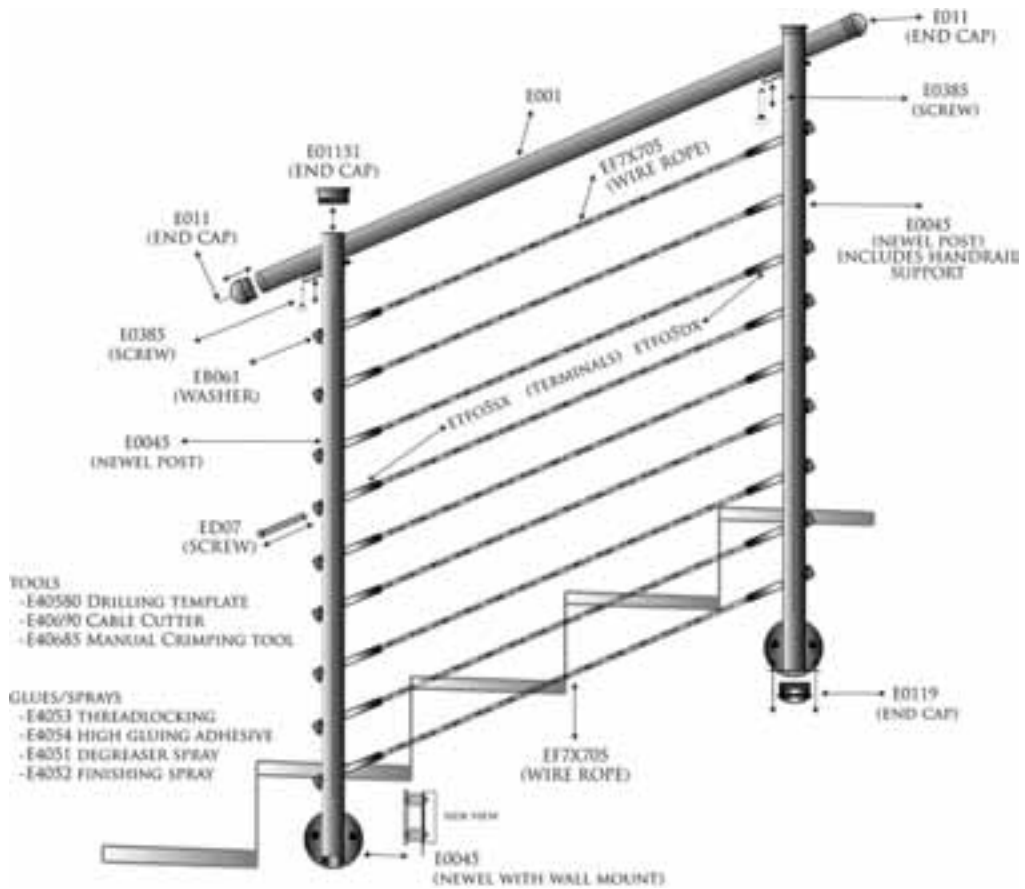



# CATALOGS

Quick Reference # 7 2011

## FERRUM AMANTIBUS - I

from page 1 to page 416

Art. 212/I

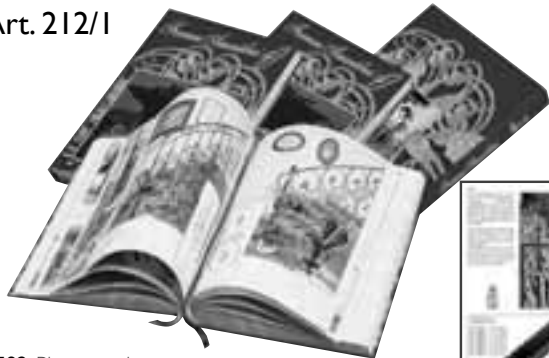

1592 Photographs.

432 Art pages overprinted in gold.

24 Technical and explanatory drawings.

12 Pages of original historical research on wrought iron production, from the Egyptians to present times.



Art. 1598/2  
box with catalogues  
(Vol. 1°, 2°, 3°, 4°)

## HOMO FABER - 2

from page 417 to page 944

Art. 938/I



540 pages showing actual pictures, technical data and example pictures of more than 3,000 ready made forgings steadily produced in our own factories and readily available for delivery.

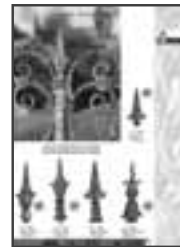

## IN FERRO QUALITAS - 3

from page 945 to page 1610

Art. 1596/I



700 Pages full with photos, technical data, actual applications on fences, grills, doors etc. of over 4,000 ready made Wrought Iron forgings.

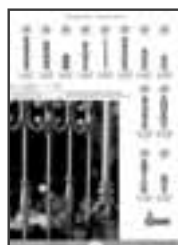

## FABER FERRARIUS - 4

from page 1611 to page 1986

Art. 3005/70



A thousand photos tells of a job started thirty years ago and grown overwhelmingly into the new millennium, always with innovative and competitive ideas to satisfy all new economic realities.

**GATES BOOK** Art. 939/1  
Pages 382



**STAIRWAYS BOOK** Art. 3005/26  
Pages 349



**DOOR and WINDOWS BOOK**



Art. 1601/1  
Pages 296

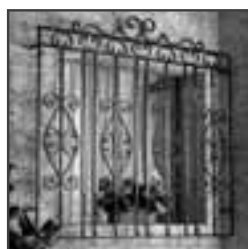

**FENCES and RAILINGS BOOK**

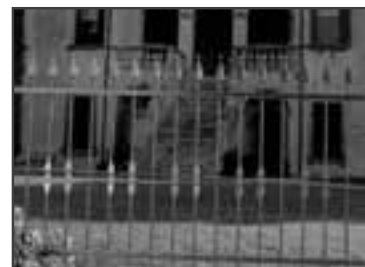
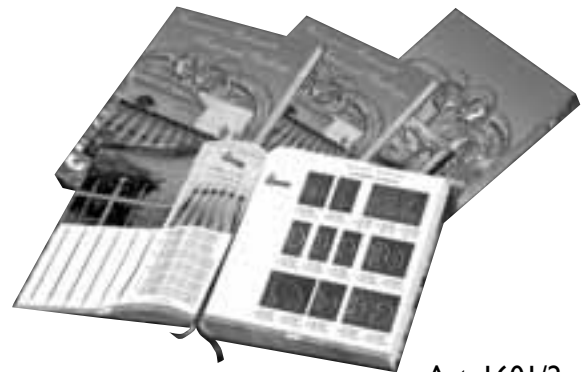

Art. 1601/2  
Pages 512



## ART FURNITURE BOOK

Art. 3005/65  
Pages 592



## DESIGNS BOOK



Art. 211/2  
Pages 346

## ART LINE

Art. 3005/2  
Pages 94



## GARDEN LINE

Art. 3005/1  
Pages 158



# ArteferroCAD

WEB CONFIGURATOR 4.0



The main change in the new version of the software, called Arteferro CAD 4 Web Configurator, is the fact that it will be offered exclusively online. This choice stems from the wish to offer the product to wrought iron "pros" and to others that have fallen in love with wrought iron and stainless steel. The software program is constantly updated as well, with the addition of new items and pre-built compositions free of charge.

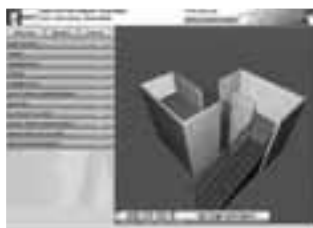

Requirements for a correct working:

- Microsoft Internet Explorer 7
- Internet line
- A 3D graphic card with video resolution of 1280x1024 or more pixel is recommended

## GONZATO DESIGN

Art. 3005/33  
Pages 250



## ARTEFERRO INOX Art. 3005/56

Pages 400



## COMPENDIUM

Art. 3005/73  
Pages 628



## POWDER COATED PICKETS Art. 3005/71

Pages 72



INDEX

Items #	Page	Items #	Page	Items #	Page	Items #	Page	Items #	Page
<b>FORGINGS</b>		42/2/US	135	64/G/5	13	94/A/6	156	112/9	111
11/12T	77	42/9/US	135	64/G/6	13	94/A/6/S	156	112/10	111
11/38T	77	44/12	106	64/H/2	105	94/A/6/S1	156	112/11	111
11/1240	77	46/6	106	64/H/4	105	94/B/3	160	112/B/9	110
11/1242	77	47/1	107	64/H/6	105	94/B/4	160	113/1	113
11/1247	77	47/9	104	64/H/8	105	94/B/5	161	113/2	113
11/3440	77	47/10	104	64/I/1	112	94/B/6	161	113/3	113
11/3442	77	47/11	104	64/I/2	79	94/B/9	160	113/4	113
11/3447	77	47/12	104	64/I/3	79	94/C/1	13	113/5	111
11/3840	77	47/11/AL	174	64/I/4	80	94/C/2	13	113/6	111
11/3842	77	47/3/ALL	174	64/I/5	80	94/C/3	13	113/7	111
11/3847	77	47/11/S/AL	174	64/L/3	79	94/C/4	13	113/8	111
11/5840	77	48/1	75	64/L/4	79	94/C/5	13	113/9	156
11/5842	77	48/2	75	64/H/10	105	94/C/6	13	113/10	156
11/5847	77	48/3	75	64/L/3/L	97	94/E/1	46	113/11	145
11/12365	77	48/4	75	64/L/4/L	97	94/E/2	46	113/12	145
11/34240	77	48/A/13	76	64/A/6/ALL	175	94/E/3	46	113/8/AL	178
11/34365	77	48/A/16	76	64/I/4/S/AL	172	94/E/4	46	113/1/25/S/ALL	178
11/38365	77	48/6/ALL	173	65/8	77	94/E/5	46	114/1	119
11/58240	77	48/7/ALL	173	65/840	77	94/E/6	46	114/2	119
11/58365	77	49/3	91	65/842	77	94/F/1	47	114/4	119
17/1	24	49/3/S8	175	65/847	77	94/F/2	47	114/5	119
17/2	24	50/5	79	70/D/1	78	94/F/3	47	114/8	119
23/1	24	50/6	79	70/D/5	105	94/F/4	47	114/9	119
23/2	24	50/7	79	73/1	16	94/F/5	47	114/11	119
24/2	24	50/8	79	73/2	16	94/F/6	47	114/12	119
24/3	24	51/3	60	73/3	16	94/B/10	160	114/A/1	119
24/F/2	7	52/1	42	78/B/4	11	94/B/11	160	114/A/2	119
26/C/1	24	52/2	89	80/A/1	9	94/B/12	160	114/A/3	119
26/C/1/ALL	170	52/A/3	89	80/A/3	9	94/C/11	46	114/B/1	124
35/1	32	52/H/3	26	80/A/9	10	94/C/12	46	114/B/2	124
35/2	32	53/1	90	80/A/10	10	98/1	68	114/B/4	124
35/1/ALL	176	53/3	77	80/A/11	10	99/1	68	114/B/5	124
35/2/ALL	176	53/340	77	80/A/12	10	99/2	68	114/B/8	124
36/1	32	53/342	77	80/C/16/ALL	177	101/2	73	114/B/10	124
36/2	32	53/347	77	84/7	11	103/2	60	114/B/11	124
36/1/ALL	176	60/3	90	88/C/2	18	105/1	68	114/B/13	123
36/2/ALL	176	60/4/ALL	175	89/2	16	105/2	68	114/B/14	123
37/3	32	62/1	60	89/4	154	105/3/L	74	114/B/15	23
37/3/ALL	176	64/A/1	91	92/B/3	12	105/4/L	74	115/1	122
41/1	165	64/A/2	91	92/B/4	12	108/A/1	72	115/2	123
41/9	165	64/A/3	90	92/C/4	6	108/A/2	72	115/3	123
41/10	165	64/B/2	90	92/C/5	6	109/3	68	115/4	123
41/11	165	64/D/4	105	93/1	12	110/3	72	115/5	123
41/12	165	64/F/1	112	93/3	12	110/4	72	116/1	124
41/14	165	64/F/3	83	93/4	12	110/5	72	116/2	124
41/15	165	64/F/5	83	94/3	12	110/6	72	116/5	124
41/18	165	64/F/7	83	94/A/1	166	111/2	71	116/5	124
41/21	165	64/F/9	83	94/A/2	166	111/3	114	116/7	124
42/4	135	64/G/2	83	94/A/3	156	112/3	112	116/8	124
42/10	135	64/G/3	13	94/A/4	156	112/5	111	116/9	124
42/24	135	64/G/4	13	94/A/5	156	112/7	111	116/10	124



INDEX

Items #	Page	Items #	Page	Items #	Page	Items #	Page	Items #	Page
116/15	124	118/E/2	128	126/19	151	136/1	161	148/1	92
116/16	124	118/E/3	128	126/20	151	136/2	161	148/2	92
116/25	125	118/E/4	128	126/A/1	149	136/3	161	149/1	92
116/26	125	118/E/5	128	126/B/1	151	136/4	161	154/2	140
116/29	125	118/E/6	128	126/B/2	151	136/5	162	155/1	140
116/31	125	118/E/7	128	126/B/3	151	136/6	162	155/2	140
116/32	125	118/E/8	128	126/B/4	154	136/7	162	155/3	140
116/33	166	118/E/9	128	126/B/6	151	136/8	162	155/4	140
116/34	166	118/H/1	78	126/B/7	151	136/9	162	155/6	140
116/35	162	118/H/2	78	126/B/8	151	136/10	161	156/3	144
116/35	166	118/1/AL	181	126/B/9	154	136/11	161	156/6	144
116/A/3	162	118/E/10	128	126/C/7	151	137/7	162	156/A/1	145
116/A/4	162	118/H25	77	126/E/1	154	137/8	162	156/A/3	145
116/A/5	162	119/1	128	128/1	140	137/9	162	156/A/4	145
116/A/8	125	119/2	128	128/2	140	137/10	162	156/A/5	145
116/A/9	125	119/3	128	128/6	140	138/2	162	156/A/6	145
116/D/1	138	120/1	148	128/7	140	138/3	162	156/A/10	166
116/D/2	138	120/2	148	128/9	140	138/4	162	157/1	145
116/E/6	138	120/3	148	128/10	140	138/7	162	157/2	145
116/F/1	145	121/4	150	128/15	140	138/10	162	157/3	145
116/F/2	145	121/5	150	128/17	140	138/11	162	157/16	145
116/F/3	145	121/6	150	128/17	140	138/12	162	158/1	128
116/F/4	145	121/7	150	128/18	140	138/13	162	158/3	128
116/F/5	145	121/8	150	128/18	140	138/15	162	158/6	128
116/F/6	145	121/9	150	128/21	140	138/16	162	158/15	128
116/F/8	145	122/A/1	148	128/21	140	139/1	162	158/16	128
116/A/12	125	123/1	145	128/22	140	139/2	162	158/20	128
116/A/14	125	123/3	151	128/22	140	139/3	162	158/23	128
116/A/15	125	123/5	149	128/28	140	139/4	162	158/26	128
116/F/10	145	123/6	151	128/28	140	139/5	162	158/27	128
116/A/3/A	182	123/7	154	128/29	156	139/6	162	158/30	128
116/F/11/ALL	180	123/B/5	151	128/30	156	140/1	162	158/B/1	142
117/1	145	124/1	149	128/31	156	140/2	162	158/B/6	142
117/2	145	124/2	149	128/32	156	140/3	162	158/B/7	142
117/3	145	124/3	154	128/33	156	140/4	162	158/B/8	142
117/4	145	124/4	154	128/34	156	140/5	162	159/1	142
117/5	145	124/5	154	128/35	156	140/6	162	159/3	142
117/6	145	124/6	154	129/1	153	140/7	162	159/4	142
117/7	145	124/7	154	129/2	153	140/8	162	159/5	142
117/8	145	124/8	154	129/3	153	140/H/1	160	159/6	142
117/9	145	124/9	149	129/4	153	140/H/2	160	159/7	142
118/1	127	125/1	148	129/5	153	140/H/3	157	160/17	95
118/2	127	125/2	148	129/6	153	140/H/3	160	160/43	156
118/3	127	125/4	154	129/7	153	140/H/4	160	160/44	156
118/5	127	126/1	149	129/8	153	140/I/3	28	160/45	156
118/6	127	126/3	162	129/9	153	140/I/3	161	160/46	156
118/29	119	126/6	151	129/10	153	140/H/3/ALL	180	160/B/6	140
118/A/1	127	126/13	151	129/11	153	140/H/4/ALL	180	160/B/7	140
118/A/2	127	126/14	151	129/12	153	144/3	92	160/H/N	61
118/A/3	127	126/15	149	134/G/3	80	145/3	115	160/H/N	165
118/A/5	127	126/16	149	134/2/ALL	171	146/1	92	160/L/1	142
118/E/1	128	126/18	151	134/10/ALL	171	146/4	92	160/L/2	142

INDEX

Items #	Page	Items #	Page	Items #	Page	Items #	Page	Items #	Page
160/L/3	142	469/1/ALL	175	527/2	95	604/8	86	626/16	128
160/D/10	212	474/1	61	527/3	95	604/11	162	626/17	128
160/D/11	212	475/1	61	530/4	94	604/12	162	626/19	128
164/7	168	475/2	61	531/1	94	605/1	135	630/1	6
164/8	168	476/1	61	533/4	94	605/2	135	630/3	6
164/9	168	476/2	61	537/1	93	605/3	135	630/4	6
164/10	168	478/1	61	537/2	93	605/4	135	630/5	6
167/4/ALL	182	478/2	61	537/3	93	606/1	135	630/6	6
168/1	164	478/3	61	537/4	93	606/2	135	634/8/ALL	177
169/11	167	478/3	165	537/5	93	606/3	135	634/4/S/ALL	177
169/15	167	479/1	61	537/6	93	606/4	135	635/1	17
170/5	167	479/2	61	537/7	93	607/1	134	635/2	17
170/6	164	480/1	29	537/8	93	607/2	134	635/3	17
170/A/2	167	480/1/S/ALL	170	537/9	93	608/6	132	635/4	17
170/A/3	167	481/8	145	540/1	18	614/4	129	639/5	110
170/A/5	167	481/D/89	145	540/2	60	614/5	129	650/1	6
170/A/7	167	481/D/127	145	541/2	43	614/6	129	650/2	6
170/B/4	167	481/8/D/133	145	560/2	84	615/1	101	650/3	6
170/B/5	167	481/8/D/140	145	560/3	84	615/2	101	650/4	6
171/37	164	485/1	37	561/6	83	615/3	101	651/1	7
171/38	164	486/1	91	562/2	83	615/4	101	651/2	7
171/39	164	487/1	91	562/2/L	96	617/1	101	651/3	7
171/40	164	488/1	91	576/2	84	617/2	101	651/4	7
171/41	164	489/1	64	576/4	84	617/3	101	658/1	6
171/42	164	489/2	64	577/1	84	617/4	101	658/2	6
181/6	156	490/1	64	577/2	84	617/5	101	658/4	6
181/10	167	490/2	64	577/3	84	617/6	101	661/1	161
181/11	167	491/7	144	578/15	104	617/7	101	661/2	161
181/11	167	491/9	145	586/7/ALL	174	623/5	126	661/3	161
181/12	167	497/1	71	597/3	78	623/6	126	661/4	157
181/12	167	497/2	71	597/3/L	98	623/7	126	661/4	161
181/13	167	499/1	69	598/9	126	623/8	126	662/3	161
181/13	168	499/2	69	598/11	126	623/9	126	662/4	161
181/14	167	500/1	72	598/13	126	625/3	127	663/1	161
181/14	168	500/2/L	74	598/16	126	625/5	127	663/2	161
181/15	167	501/2	72	599/1	126	625/7	127	663/3	161
181/10/AL	180	502/1	73	599/2	126	625/8	127	663/4	161
181/11/AL	180	503/1	73	599/3	126	625/9	127	663/5	161
211/2	260	504/1	85	599/4	126	625/10	127	663/6	161
212/1	258	504/2	70	599/5	126	626/1	118	663/7	161
446/4	25	504/3	70	599/6	126	626/3	128	663/8	161
451/1	25	505/3	70	599/7	126	626/4	128	673/1	157
460/1	26	505/4	70	599/8	126	626/5	128	673/1	160
462/1	76	508/2	68	600/1	126	626/6	128	673/2	160
462/2	76	508/3	71	600/2	126	626/7	128	673/3	160
462/3	76	508/4	71	600/3	126	626/8	128	673/3/ALL	180
462/4	76	511/1	60	600/4	126	626/9	128	679/1	29
464/1	40	511/1/AL	176	600/6	126	626/11	128	679/2	28
464/2	40	518/1	75	600/7	126	626/12	128	679/3	29
464/3	40	523/1	75	600/9	126	626/13	128	681/1	44
464/4	40	523/3	75	604/6	86	626/14	128	681/2	44
469/1	91	525/1	95	604/7	86	626/15	128	681/3	44

INDEX

Items #	Page	Items #	Page	Items #	Page	Items #	Page	Items #	Page
681/4	44	696/3	161	747/16	141	770/11	177	810/A/20/T	120
681/5	45	697/3	162	747/17	141	770/12	177	810/B/16/T	120
681/6	45	697/4	162	755/2	66	770/13	179	810/B/17/T	120
681/7	45	702/1	162	755/3	66	770/14	179	810/B/18/T	120
681/8	45	702/2	162	755/4	66	770/15	172	810/B/20/T	122
682/1	45	702/3	162	755/5	78	770/2/DX	179	810/B/15/ALL	181
682/2	45	715/1	50	755/6	78	771/1	182	811/2	119
682/10	45	715/2	50	756/2	158	771/2	182	811/8	119
682/11	45	718/1	22	756/4	158	771/3	182	811/6/T	122
684/6	144	719/1	28	756/12	158	771/4	182	811/7/T	118
685/3	44	719/2	29	756/12	158	771/5	182	811/8/T	122
685/4	29	720/1	28	756/14	158	771/6	182	811/3/ALL	181
685/4	44	720/2	28	757/5	182	771/7	182	811/5/ALL	181
685/5	44	722/1	153	767/1	170	771/8	182	811/6/ALL	181
685/6	44	722/2	153	767/2	175	771/9	182	811/7/ALL	181
687/3	45	722/3	153	767/3	175	771/10	182	811/7(MCR)	119
687/6	45	722/4	153	768/1	172	771/11	182	811/6/58(MCR112)	119
689/7	160	722/5	153	768/2	172	771/12	182	812/12	123
689/8	160	722/6	153	768/3	172	771/13	182	812/13	213
689/9	160	724/1	150	768/4	172	771/14	182	812/14	123
689/10	160	725/1	154	768/5	172	772/1	181	812/12/T	124
691/1	160	725/2	154	768/6	172	772/2	181	812/13/T	124
691/2	160	725/3	154	768/7	172	772/3	181	812/15/T	124
691/3	160	725/4	154	768/8	172	772/4	181	819/1	156
691/4	160	725/4	154	768/9	172	772/5	181	819/6	156
691/5	160	725/5	154	768/10	172	772/6	181	819/8	156
691/6	160	726/3	150	768/11	173	772/7	181	819/2/5	156
691/7	160	727/1	151	768/12	173	772/8	182	839/1	164
692/1	160	727/2	151	769/1	171	772/9	182	839/3	164
692/2	160	727/3	151	769/2	171	772/10	182	938/1	258
692/3	160	727/4	151	769/3	174	772/11	182	939/1	259
692/4	160	727/5	151	769/4	174	772/12	182	1009/1	24
692/6	160	727/6	151	769/5	171	772/13	182	1009/2	24
692/8	160	727/7	151	769/6	171	772/14	182	1010/1	24
692/9	160	727/8	151	769/7	171	772/15	182	1010/2	24
692/10	160	727/9	151	769/8	171	772/16	173	1010/3	25
694/12	160	727/10	151	769/9	173	772/17	173	1011/1	25
694/13	160	727/11	151	769/10	173	797/2	112	1011/2	25
695/1	161	745/1	61	769/11	173	797/7	112	1011/3	25
695/2	161	745/1	165	769/12	174	798/2	111	1012/1	26
695/3	161	746/4	141	769/13	171	799/1	110	1012/2	26
695/4	161	746/5	141	769/3/5	174	799/3	111	1013/1	27
695/5	161	746/6	141	770/1	179	801/4	115	1013/2	27
695/6	165	746/6	141	770/2	179	801/5	112	1014/2	25
695/7	165	747/8	141	770/3	179	802/1	113	1017/3	26
695/8	165	747/9	141	770/4	179	802/2	113	1017/4	26
695/9	165	747/10	141	770/5	179	806/6	115	1019/2	24
695/10	165	747/11	141	770/6	179	807/1	115	1028/1	26
695/11	165	747/12	141	770/7	179	810/B/5/T	121	1028/2	26
695/12	165	747/13	141	770/8	179	810/B/6/T	121	1038/1	49
696/1	138	747/14	141	770/9	179	810/B/7/T	121	1038/2	49
696/2	161	747/15	141	770/10	179	810/B/8/T	121	1038/3	18

INDEX

Items #	Page	Items #	Page	Items #	Page	Items #	Page	Items #	Page
1038/1/ALL	176	1090/3/ALL	171	1150/3	76	1163/3	142	1229/7	95
1039/1	49	1091/1	81	1150/4	76	1163/4	142	1229/8	95
1039/2	18	1091/2	81	1156/1	97	1163/12	142	1231/1	95
1039/3	18	1097/1	62	1156/2	97	1166/1	82	1231/2	95
1043/1	48	1097/3	62	1156/3	97	1166/2	82	1231/3	95
1043/2	48	1097/3	102	1156/4	97	1166/3	82	1231/4	95
1043/1/ALL	176	1111/1	62	1156/5	97	1166/4	82	1234/3	95
1043/2/ALL	176	1111/2	62	1156/6	97	1167/1	82	1259/1	152
1046/1	48	1115/1	62	1156/7	97	1167/2	82	1259/2	152
1046/2	48	1115/1	102	1156/8	97	1167/3	82	1259/3	152
1046/3	16	1115/2	62	1156/9	97	1167/4	82	1259/5	152
1046/4	16	1115/2	102	1156/10	98	1170/1	86	1259/6	152
1046/5	16	1118/1	62	1156/11	98	1171/1	86	1259/7	152
1046/6	16	1118/2	62	1156/12	98	1171/2	86	1259/8	152
1046/7	16	1118/3	62	1156/13	98	1179/3	80	1259/13	152
1046/1/ALL	176	1118/4	62	1156/14	98	1179/4	80	1259/14	152
1046/3/ALL	177	1131/3	101	1156/15	98	1184/1	75	1259/15	152
1046/4/ALL	177	1132/9	78	1156/16	98	1184/2	75	1259/16	152
1046/5/ALL	177	1135/1	84	1156/17	98	1184/3	73	1259/19	152
1046/6/ALL	177	1135/2	84	1156/18	98	1184/4	70	1259/20	152
1046/7/ALL	177	1135/3	84	1157/1	96	1184/5	70	1259/4.	152
1049/1	89	1135/4	84	1157/2	96	1184/6	73	1281/1	138
1050/2	61	1136/1	85	1157/3	96	1185/1	72	1281/2	138
1050/3	61	1136/2	85	1157/4	96	1185/2	72	1281/3	138
1051/1	89	1136/7	85	1157/5	96	1185/3	73	1281/4	138
1051/2	89	1136/8	85	1157/8	96	1185/4	73	1281/11	8
1051/3	89	1136/9	85	1158/1	96	1185/5	73	1295/1	17
1051/4	43	1136/10	85	1158/2	96	1187/1	65	1295/2	17
1051/5	43	1141/1	102	1158/3	97	1187/2	65	1295/3	17
1051/2/ALL	175	1141/2	102	1158/4	97	1187/4	65	1295/4	17
1053/1	102	1142/1	62	1158/9	97	1187/5	65	1295/5	17
1054/4	102	1142/2/5	62	1158/10	97	1192/1	73	1295/6	17
1054/5	102	1143/1	7	1158/12	96	1192/2	73	1295/7	17
1054/6	102	1143/2	7	1158/13	96	1192/5	64	1296/12	17
1055/2	101	1144/1	15	1158/14	96	1192/6	64	1296/13	17
1068/1	101	1144/2	15	1158/15	96	1203/1	115	1299/5	144
1068/2	101	1144/3	15	1158/16	96	1203/2	115	1299/6	144
1068/3	101	1144/4	15	1158/17	96	1206/1	110	1309/1	18
1068/4	101	1144/5	15	1159/1	74	1207/1	114	1309/2	18
1073/3	102	1144/6	15	1159/2	74	1207/2	114	1309/3	18
1074/1	102	1145/3	7	1159/5	74	1207/3	114	1309/4	18
1074/2	102	1145/3	15	1159/6	74	1207/4	114	1309/5	18
1075/1	102	1149/1	76	1159/7	74	1215/1	74	1317/1	145
1075/2	102	1149/2	76	1159/8	74	1215/2	74	1317/2	145
1089/1	82	1149/3	76	1159/9	97	1215/3	74	1317/3	144
1089/2	82	1149/4	76	1159/10	97	1215/4	74	1317/8	145
1089/3	102	1149/5	76	1159/11	96	1229/1	94	1317/18	145
1089/4	102	1149/6	76	1159/12	96	1229/2	94	1317/19	145
1090/1	82	1149/7	115	1160/1	98	1229/3	94	1317/20	145
1090/2	82	1149/8	115	1160/2	98	1229/4	94	1318/9	144
1090/3	82	1150/1	76	1160/4	98	1229/5	94	1329/1	159
1090/4	82	1150/2	76	1160/6	97	1229/6	94	1329/6	159

INDEX

Items #	Page	Items #	Page	Items #	Page	Items #	Page	Items #	Page
1331/2	159	1382/12	152	1435/1	170	1444/14	172	1451/5	183
1331/4	159	1382/13	152	1435/2	170	1444/15	172	1451/6	183
1361/1	135	1382/14	152	1435/3	175	1444/16	172	1451/7	183
1361/2	135	1382/15	152	1435/4	175	1444/17	172	1451/8	183
1361/3	135	1382/16	152	1435/5	175	1444/9/5	174	1451/9	183
1361/4	135	1382/17	152	1436/1	180	1445/1	178	1451/10	183
1370/13	127	1382/18	152	1436/2	180	1445/2	178	1452/1	183
1370/6/6000/AL	181	1382/19	152	1436/3	180	1445/5	178	1452/2	184
1373/4	119	1382/20	152	1436/4	180	1446/1	178	1452/3	184
1374/15	128	1382/21	152	1436/5	180	1446/2	178	1452/4	184
1374/16	128	1382/22	152	1437/1	181	1446/3	178	1452/5	184
1374/17	128	1385/4	153	1437/2	181	1446/4	178	1452/6	184
1374/18	128	1385/5	153	1437/3	181	1446/5	178	1452/7	184
1374/19	128	1385/6	153	1437/4	181	1446/6	178	1452/8	184
1374/20	128	1385/7	153	1437/5	181	1446/3/5	178	1452/9	184
1374/15/AL	181	1385/8	153	1437/6	181	1447/10	181	1452/10	184
1375/1	118	1385/9	153	1437/7	181	1447/12	181	1453/1	184
1377/12	123	1385/10	153	1437/8	181	1447/21	181	1453/2	184
1377/25	123	1385/11	153	1437/9	181	1447/29	181	1453/3	184
1377/38	213	1385/12	153	1437/10	181	1447/31	181	1453/4	184
1377/40	123	1385/13	153	1437/11	181	1447/32	181	1453/5	184
1377/41	123	1385/14	153	1437/12	181	1447/33	181	1453/6	184
1377/1/T	124	1385/15	153	1437/13	181	1447/34	181	1453/7	184
1377/2/T	124	1386/1	153	1437/14	181	1447/35	181	1453/8	184
1377/3/T	124	1386/2	153	1437/15	181	1447/36	181	1454/1	184
1377/4/T	124	1386/3	153	1437/16	179	1447/37	181	1454/2	184
1377/5/T	124	1386/4	153	1437/17	179	1447/38	181	1454/3	184
1377/7/T	124	1386/5	153	1437/18	179	1448/1	178	1454/4	184
1377/8/T	124	1386/6	153	1437/19	179	1448/2	178	1454/5	184
1377/9/T	124	1386/7	153	1437/20	181	1448/3	178	1454/6	184
1377/14/T	124	1386/8	153	1438/1	177	1448/4	180	1454/7	184
1377/15/T	124	1386/9	153	1438/2	177	1448/5	180	1454/8	184
1377/16/T	124	1386/10	153	1438/3	177	1448/6	180	1454/9	184
1377/17/T	124	1386/11	153	1440/1	173	1448/7	180	1454/10	184
1377/18/T	124	1386/12	153	1440/2	173	1448/8	180	1454/11	184
1377/20/T	124	1386/13	153	1443/1	182	1448/9	180	1454/12	183
1377/21/T	124	1393/8	158	1443/2	182	1448/10	180	1454/13	183
1377/22/T	124	1404/1	156	1443/3	182	1448/11	180	1454/14	183
1377/40/T	124	1404/2	156	1443/4	182	1450/1	183	1454/15	183
1377/41/T	124	1404/3	156	1443/5	182	1450/2	183	1454/16	183
1377/42/T	124	1404/4	156	1443/6	182	1450/3	183	1463/14	161
1382/1	152	1405/1	166	1443/7	182	1450/4	183	1463/15	161
1382/2	152	1405/2	166	1443/8	182	1450/5	183	1463/17	161
1382/3	152	1405/3	166	1443/9	182	1450/6	183	1463/17	161
1382/4	152	1406/3	158	1443/10	182	1450/7	183	1474/1	164
1382/5	152	1406/7	158	1443/11	182	1450/8	183	1474/2	164
1382/6	152	1406/9	158	1443/12	182	1450/9	183	1474/3	164
1382/7	152	1408/1	156	1443/13	182	1450/10	183	1475/2	163
1382/8	152	1408/2	156	1444/8	174	1451/1	183	1476/1	166
1382/9	152	1408/5	156	1444/11	173	1451/2	183	1476/2	166
1382/10	152	1408/6	156	1444/12	173	1451/3	183	1476/3	166
1382/11	152	1432/1	255	1444/13	173	1451/4	183	1476/4	166

INDEX

Items #	Page	Items #	Page	Items #	Page	Items #	Page	Items #	Page
1476/5	166	1701/15	115	1729/6	101	1789/1	106	1822/8	125
1476/6	166	1702/2	99	1729/8	101	1789/2	106	1822/9	125
1476/7	166	1702/4	99	1729/10	101	1789/3	106	1822/10	125
1476/8	166	1702/6	99	1729/12	101	1789/4	106	1822/12	125
1476/9	167	1702/8	99	1730/2	100	1789/5	106	1822/13	125
1476/10	167	1702/10	99	1730/4	100	1791/1	106	1822/17	125
1476/11	167	1702/12	99	1730/6	100	1793/1	95	1822/18	125
1476/12	167	1702/14	107	1730/8	100	1793/2	95	1822/19	125
1476/13	167	1702/15	115	1733/10	99	1793/3	95	1822/20	125
1476/14	167	1702/14/ALL	174	1733/12	99	1793/4	95	1822/21	125
1491/1	141	1705/2	99	1733/13	64	1802/4	145	1825/9	125
1491/2	141	1705/4	99	1733/15	64	1802/85	145	1825/10	125
1491/3	141	1705/6	99	1749/2	80	1802/91	145	1825/11	125
1491/4	141	1705/8	99	1749/4	80	1802/92	145	1825/12	125
1491/5	141	1705/10	99	1749/6	80	1802/93	145	1825/13	125
1596/1	258	1705/12	99	1749/8	80	1802/99	145	1825/14	125
1601/1	259	1705/14	107	1765/11	153	1802/100	145	1825/15	125
1601/2	259	1705/15	115	1765/16	153	1802/101	145	1825/16	125
1641/1	26	1710/2	99	1765/26	153	1802/102	145	1825/17	125
1652/1	27	1710/4	99	1765/31	153	1802/108	145	1825/18	125
1652/5	27	1710/6	99	1765/41	153	1802/109	145	1834/1	129
1653/1	27	1710/8	99	1765/46	153	1802/110	145	1834/2	129
1653/2	27	1710/10	100	1770/1	69	1802/111	145	1834/2	145
1657/1	26	1710/12	100	1770/2	69	1806/13	129	1834/3	129
1657/4	27	1710/14	100	1770/3	69	1806/27	129	1834/4	129
1658/1	27	1710/16	100	1770/4	69	1807/1	129	1834/5	129
1659/1	27	1710/18	100	1770/5	71	1807/13	129	1837/6	129
1665/18	23	1710/20	100	1770/6	71	1813/1	165	1853/1	132
1667/2	20	1710/22	100	1770/7	71	1813/2	165	1853/51	132
1667/2	20	1710/24	100	1770/8	69	1817/4	123	1853/54	132
1667/3	20	1713/2	100	1775/13	112	1817/7	123	1853/105	132
1668/2	22	1713/4	100	1775/14	112	1818/5	124	1853/108	132
1670/1	42	1713/6	100	1775/15	112	1818/6	124	1853/159	132
1670/2	37	1713/8	100	1775/12/S1/AL	178	1818/15	124	1853/162	132
1670/1/ALL	170	1713/10	100	1777/1	115	1818/16	124	1853/177	132
1671/3	42	1713/12	100	1777/4	115	1819/10	123	1853/180	132
1671/6	37	1716/14	100	1777/5	115	1819/11	123	1853/195	132
1671/3/ALL	170	1716/16	100	1777/6	115	1820/1	124	1853/198	132
1682/1	62	1716/20	100	1779/14	107	1820/2	124	1867/1	170
1682/2	62	1716/22	100	1780/10	107	1820/3	124	1867/2	170
1685/1	62	1716/24	100	1780/12	107	1820/4	124	1867/3	170
1685/2	62	1716//18	100	1780/14	107	1820/5	124	1867/4	179
1685/3	88	1724/13	77	1780/16	107	1820/6	124	1867/5	177
1699/3	88	1724/14	77	1782/1	105	1820/7	124	1867/6	177
1699/9	88	1724/27	77	1782/7	105	1820/8	124	1867/7	179
1701/2	99	1724/28	77	1782/8	105	1820/9	124	1869/1	177
1701/4	99	1724/51	77	1783/3	104	1820/10	124	1869/2	177
1701/6	99	1724/52	77	1783/5	104	1820/11	124	1869/3	177
1701/8	99	1725/1	77	1783/3/AL	174	1822/1	125	1869/4	177
1701/10	99	1725/2	77	1783/5/AL	174	1822/2	125	1869/5	176
1701/12	99	1729/2	101	1783/9/ALL	174	1822/6	125	1869/6	172
1701/14	107	1729/4	101	1785/4	106	1822/7	125	1869/7	172

INDEX

Items #	Page	Items #	Page	Items #	Page	Items #	Page	Items #	Page
1869/8	171	E00204040	218	E00691	227	E00921	229	E0130	233
1869/9	171	E00204040	228	E006910	227	E0093	229	E01301	233
1869/10	171	E0040	234	E006911	227	E00950	229	E0131	219
1869/11	173	E0040316	234	E006913	227	E00951	229	E01316	244
1871/1	181	E0041	234	E006914	227	E00955	229	E014	219
1871/2	181	E00411	234	E00692	227	E00956	229	E0141	219
1871/3	181	E00411316	234	E00693	227	E00971	229	E015	220
1871/4	181	E0041316	234	E006966	227	E00972	229	E016	220
1871/5	181	E0042	234	E006966316	227	E00973	229	E017	220
1871/6	181	E0042/10	234	E00697110	227	E00981	229	E0181	220
3005/1	260	E0042/10316	234	E006976	227	E00983	229	E0182	220
3005/2	260	E0042/2	234	E006977	227	E01	244	E0183	220
3005/26	259	E0042/2316	234	E006999	227	E010	233	E019	220
3005/33	261	E0042/4	234	E0069991	227	E0101	233	E019/38	220
3005/56	261	E0042/4316	234	E0069996	227	E0102	222	E0191	220
3005/65	260	E0042/904	234	E0069997	227	E0102316	222	E02	244
3005/70	258	E0042/904316	234	E0070	227	E0104	222	E020	220
3005/71	261	E00422	234	E00700	227	E0104316	222	E020/38	220
3005/73	261	E00422316	234	E00700316	227	E011	232	E02011	220
810B/19/ALL	181	E0042316	234	E0071	227	E0111	232	E0204	220
H100412PBC	133	E0043	234	E00710	227	E01111	232	E02050	228
H1004PBC	133	E0043316	234	E00710316	227	E01112	232	E02050316	228
H1005PBC	133	E0045	235	E00730	230	E0115	232	E02051	228
H1006PBC	133	E00450	234	E00731	230	E0115/38	232	E02051316	228
H1120412PBC	133	E004501	234	E00732	230	E01151	232	E02052316	228
H1120434PBC	133	E004501316	234	E0074	227	E01155	232	E0212	218
H1120512PBC	133	E00450316	234	E00840	231	E01158	232	E0213	218
H1120534PBC	133	E00451	234	E00840/C	231	E0117	232	E022/S	223
H1120612PBC	133	E00451316	234	E00840/R1	231	E0118	232	E022/S1	223
H1120634PBC	133	E00452	235	E00840/R2	231	E0119	232	E022/S1316	223
H2118434PBC	133	E00452316	235	E00840/R3	231	E0119/38	232	E02212	232
H2118534PBC	133	E0045316	235	E00840/R4	231	E01190	232	E0222	223
H2118634PBC	133	E0046	234	E00840/R5	231	E011931	224	E0223	223
NEW0009	23	E0046316	234	E00842	231	E011941	224	E0223/38	223
NEW0010	23	E0047	234	E00843	231	E011947	224	E02231	223
NEW0016	23	E0047316	234	E00845	231	E011948	224	E02231/38	223
MCRMTH	118	E005	218	E00850	230	E01196	232	E02231316	223
<b>INOX</b>		E0050	218	E00851	230	E01196/38	232	E0223316	223
E/PAN13	255	E0050/6000	218	E00860	230	E01196100	233	E0224	223
E/PAN14	255	E0051	218	E00871	230	E01197	224	E0224	253
E000463	245	E0051/6000	218	E00880	231	E01197/38	224	E0225	223
E000463316	245	E0052	218	E00881	231	E011971	224	E0226	223
E000465	245	E0052/6000	218	E00882316	231	E011976	224	E02316	244
E000465316	245	E00559	244	E00883316	231	E012	233	E024	225
E001	218	E00559316	244	E009	229	E0120	233	E0241	225
E001/38	218	E006	227	E009/38	229	E01212	232	E028/180	225
E001/38/6000	218	E006316	227	E0090	229	E01261	233	E028/30	225
E001/6000	218	E0066	227	E0091	229	E0127	233	E028/45	225
E0011	218	E00669	244	E00911	229	E0128	233	E028/60	225
E0011/6000	218	E00669316	244	E00912	229	E01281	233	E028/90	225
E0014	218	E0069	227	E00913	229	E0129	233	E0281/180	225
E0014/6000	218	E0069/38	227	E0092	229	E013	219	E0281/30	225

## INDEX

Items #	Page	Items #	Page	Items #	Page	Items #	Page	Items #	Page
E0281/45	225	E039300	222	E1999800	249	E40593	255	E461	233
E0281/60	225	E04	244	E1999810	249	E406	219	E465	233
E0281/90	225	E04316	244	E1999830	249	E40651	227	E468	233
E03	244	E05	244	E1999850	249	E40680	256	E469	233
E030	221	E05316	244	E1999860	249	E40685	256	E4701	228
E030/S	221	E064	220	E2000100	230	E40690	256	E4713	228
E030/S/316	221	E065	220	E2000100	230	E4072	220	E4723	228
E030/S/38	221	E0682	220	E2000200	230	E4072/38	220	E4733	228
E030/S/38/316	221	E0691	220	E2004	225	E4073	220	E4743	228
E030/S1	221	E0691/D	220	E2014	226	E4077	220	E4760	228
E030/S1316	221	E0696	220	E2015	226	E4090	232	E4801/38	218
E0301	221	E0696/D	220	E2020	226	E4091	232	E4801/38/6000	218
E031	221	E1000424	247	E203	225	E4100	232	E4801	218
E031/S	222	E1000483	247	E203/38	225	E4130	232	E4801/6000	218
E031/S1	221	E10204040	228	E2031	225	E4141	232	E4806/38	218
E031/S1316	221	E1020440	218	E20321	225	E41651	227	E4806/6000	218
E031/S2	221	E1100000	247	E2035	225	E4230	228	E481	233
E031/S38	221	E1100100	247	E20371	225	E4260	253	E4851	218
E031/S38/316	221	E1100110	247	E2045	225	E4265	253	E4851/6000	218
E031/S6	223	E1100424	247	E2054	224	E4308	233	E491	224
E0311	221	E1100483	247	E20621	226	E4309	233	E494	224
E032	255	E111	219	E2200300	230	E446	226	E500/424	221
E0321	255	E111/38	219	E2200300	230	E446/38	226	E510/424	221
E0322	255	E1114	219	E315	232	E4471	225	E5587	226
E0323	255	E112	219	E316	232	E4471/38	225	E600	253
E0325	255	E11420	219	E400	219	E4483	218	E600/D	254
E0330	255	E11440	219	E400/304	219	E4491	226	E600/D1	254
E0330/S	255	E11440	228	E401	219	E450	225	E600/T	254
E0330316	255	E116	219	E401/304	219	E450/38	225	E601	253
E03316	244	E1200100	247	E4019/38	220	E451	226	E602	253
E035	255	E1200110	247	E403	218	E451/38	226	E603	253
E0351	255	E1300100	247	E4032	231	E452	233	E604	253
E035300	223	E1300110	247	E4042	227	E453	225	E605	253
E035300316	223	E1400100	247	E404304	218	E453/38	225	E6080	253
E036	255	E1400110	247	E4051	256	E454	224	E690	253
E037200	228	E1500100	247	E40510	231	E4541	224	E690/3000	253
E037210	228	E1500110	247	E4052	256	E455	226	E690/3000/G	253
E037600	228	E1600100	249	E4052/D	256	E455/38	226	E690/G	253
E037610	228	E1600500	249	E4052/P	256	E455200	226	E692	253
E0381	255	E1600600	249	E4053	256	E456	218	E692/3000	253
E0382	255	E1600700	249	E4054	256	E456/38	218	E706	226
E0383	255	E1700200	249	E40560	231	E4561	219	E802	226
E0383316	255	E1700300	249	E40570	231	E4566	219	EA05	250
E0384	255	E1700500	249	E40580	255	E457	233	EB061	250
E0385	255	E1700600	249	E40581	231	E4572	233	EB061316	250
E038500	222	E1700700	249	E40583	231	E458	221	EB063	250
E03851	255	E1999100	247	E40590	255	E4581	221	EB063316	250
E0385316	255	E1999200	247	E40590M5	255	E4583	223	ED05	250
E0386	255	E1999300	247	E40590M6	255	E4583/424	223	ED05316	250
E0386316	255	E1999400	247	E40590M8	255	E4584/424	223	ED06	250
E038700	222	E1999500	247	E40591	255	E4586	253	ED06SX	250
E039100	222	E1999650	247	E40592	255	E459	223	ED07	250



INDEX

Items #	Page	Items #	Page	Items #	Page	Items #	Page	Items #	Page
EF7X1904	250	ER43302PDX	240	I006966	227	GD003	56	GD159/2	52
EF7X1905	250	ER43302PSX	240	I0070	227	GD0030	140	GD163/1	52
EF7X1906	250	ER43304P	240	I010	233	GD0031	140	GD163/2	52
EF7X704	250	ER44202PDX	240	I01112	232	GD0032	14	GD164/1	53
EF7X705	250	ER44202PSX	240	I0119	232	GD0032	59	GD164/2	53
EF7X706	250	ER44204P	240	I01196	232	GD0033	14	GD175/7	36
EK2421209	237	ESF051	251	I0182	220	GD0033	59	GD176/1	87
EK4421209	237	ESF061	251	I020	220	GD0034	14	GD176/3	87
EL2331209	237	EST041DX	251	I0223	223	GD0034	59	GD183/1	35
EL2421009	237	EST041SX	251	I028/90	225	GD0035	14	GD184/1	35
EL2421209	237	ET06	250	I030/S1	221	GD0035	59	GD184/2	35
EL4331209	237	ETF05DX	250	I031/S1	221	GD0036	39	GD192/3	87
EL4421009	237	ETF05SX	250	I2015	226	GD0037	39	GD193/1	87
EL4421209	237	ETF06DX	250	I446	226	GD0038	39	GD212/1	51
EM2331209	235	ETF06SX	250	I450	225	GD0039	37	GD222/2	53
EM233120990	236	ETFF05	252	I451	226	GD004	58	GD223/1	53
EM2421009	235	ETFF06	252	I453	225	GD0040	37	GD228/2	88
EM242100990	236	ETFM06DX	250	<b>GONZATO DESIGN</b>		GD0041	38	GD23/1	87
EM2421209	235	ETFM06SX	250	GD001	58	GD0042	38	GD245/1	36
EM242120990	236	ETFS06	252	GD0010	54	GD0043	39	GD245/2	36
EM4331209	235	ETFT05	252	GD0011	54	GD0044	39	GD25/1	87
EM433120990	236	ETM05DX	250	GD0012	56	GD0045	38	GD251/3	65
EM4421009	235	ETM05SX	250	GD0013	54	GD0046	38	GD251/4	65
EM442100990	236	ETM06DX	250	GD0014	54	GD0047	39	GD253/1	52
EM4421209	235	ETM06SX	250	GD0015	55	GD0048	8	GD253/1	52
EM442120990	236	ETMS06DX	252	GD0016	55	GD0049	8	GD255/1	52
EP23302P	240	ETMS06SX	252	GD0017	55	GD005	58	GD255/1	52
EP23304P	239	ETMT06DX	252	GD0018	55	GD0050	8	GD39/1	41
EP23304P90	239	ETMT06SX	252	GD0019	57	GD0051	8	GD39/2	41
EP24202P	240	ETSM10	252	GD002	58	GD006	57	GD39/3	41
EP24204P	239	ETTB05	251	GD0020	56	GD007	57	GD41/1	88
EP24204P90	239	ETTB06	251	GD0021/Q16	104	GD008	54	GD41/2	41
EP43302P	240	EW2421211F	238	GD0021/Q20	104	GD009	54	GD58/3/ALL	171
EP43304P	239	EW2421211S	238	GD0022/DX	14	GD106/1	77	GD59/2/ALL	171
EP43304P90	239	EW4421211F	238	GD0022/DX	59	GD106/2	77	GD61/1	51
EP44202P	240	EW4421211S	238	GD0022/SX	14	GD106/3	77	GD61/1/ALL	176
EP44204P	239	<b>STEELNOX</b>		GD0022/SX	59	GD106/4	77	GD76/1	34
EP44204P90	239	I001	218	GD0023/DX	14	GD106/5	77	GD76/2	34
EQ23002P	243	I001/6000	218	GD0023/DX	59	GD106/6	77	GD99/1	36
EQ2301209	243	I0040	241	GD0023/SX	14	GD106/7	77	<b>POWDER COAT</b>	
EQ24002P	243	I0041	241	GD0023/SX	59	GD106/8	77	PC 10/1	199
EQ2401209	243	I0042	241	GD0024	14	GD106/9	77	PC 10/2	199
EQ43002P	243	I00422	241	GD0024	59	GD150/2	34	PC 10/3	199
EQ4301209	243	I0043	241	GD0025	14	GD150/3	34	PC 10/4	199
EQ44002P	243	I00441	241	GD0025	59	GD151/1	34	PC 12/1	200
EQ4401209	243	I0045	242	GD0026	14	GD151/1	34	PC 16/1	200
ER23302PDX	240	I00450	241	GD0026	59	GD151/2	20	PC 16/2	200
ER23302PSX	240	I00451	241	GD0027	14	GD156/1	88	PC 18/1	200
ER23304P	240	I005	218	GD0027	59	GD156/2	88	PC 18/2	200
ER24202PDX	240	I005/6000	218	GD0028	14	GD158/1	88	PC 18/3	200
ER24202PSX	240	I006	227	GD0028	59	GD158/2	88	PC 19/1	201
ER24204P	240	I0069	227	GD0029	112	GD159/1	52	PC 19/2	201

INDEX

Items #	Page	Items #	Page	Items #	Page	Items #	Page
PC20/1	204	PC52/1	67	TMBB11C	187	TMBST25R	188
PC22/1	195	PC52/1	201	TMBB14B	190	TMBT40C	189
PC22/1	204	PC52/2	67	TMBB14B	190	TMBT695A	192
PC22/2	204	PC52/2	201	TMBB22C	190	TMBT695B	192
PC22/3	204	PC54/1	214	TMBB7C	187	TMBTB35M1	191
PC22/4	204	PC55/1	214	TMBC680A	192	TMBTB35M2	191
PC22/5	204	PC55/2	214	TMBC680B	192	TMBTS35G1	191
PC24/1	209	PC55/3	214	TMBC690A	192	TMBTS35G2	191
PC26/1	67	PC56/1	213	TMBC690B	192	TMBTS35H1	191
PC26/1	207	PC56/2	213	TMBCB215	189	TMBTS35H2	191
PC28/1	209	PC56/3	213	TMBCB24B	189	TMBTS35I1	191
PC28/2	197	PC57/1	213	TMBCB25B	188	TMBTS35I2	191
PC28/3	197	PC57/2	213	TMBCB35N1	191		
PC28/4	197	PC58/1	213	TMBCB35N2	191		
PC28/5	197	PC58/2	213	TMBCB40B	189		
PC28/6	197	PC58/3	213	TMBCB43B	187		
PC28/7	197	PC6/1	198	TMBCB235A	192		
PC30/1	210	PC6/2	198	TMBCB235A	192		
PC30/2	210	PC6/3	198	TMBCT43C	187		
PC32/1	207	PC6/4	198	TMBLT11I	188		
PC33/1	67	PC6/5	198	TMBLT22I	190		
PC33/1	207	PC6/6	198	TMBLT25I	188		
PC33/2	67	PC60/5	212	TMBN109A	187		
PC33/2	207	PC60/7	212	TMBN109B	187		
PC34/1	210	PC60/8	212	TMBN112A	189		
PC34/2	210	PC60/9	212	TMBN112B	189		
PC34/3	210	PC60/10	212	TMBN11A	187		
PC34/4	210	PC60/13	212	TMBN11B	187		
PC38/1	211	PC60/16	212	TMBN142A	187		
PC38/2	211	PC60/1/AL	212	TMBN142B	187		
PC38/3	211	PC60/3/AL	212	TMBN14A	190		
PC4/1	197	PC60/4/AL	212	TMBN15A	190		
PC4/2	197	PC60/6/AL	212	TMBN22A	190		
PC4/3	197	PC60/17/AL	212	TMBN22B	190		
PC4/4	197	PC8/1	197	TMBN24A	189		
PC4/5	197	PC8/2	197	TMBN25A	188		
PC4/6	197	PC8/3	197	TMBN35A	191		
PC40/1	211	PC8/4	197	TMBN35B	191		
PC42/1	211	PC8/5	197	TMBN40A	189		
PC42/2	211	PC8/6	197	TMBN43A	187		
PC44/1	211	<b>TORNEADOS MUNOZ</b>		TMBN45A	190		
PC44/2	211	TM745BR	188	TMBN7A	187		
PC45/1	203	TM745SR	188	TMBN7B	187		
PC45/2	203	TM751SR	188	TMBRC705A	192		
PC46/1	202	TMBA35J1	191	TMBRC705B	192		
PC47/1	67	TMBA35J2	191	TMBRT11D	188		
PC47/1	202	TMBA35K1	191	TMBRT22D	190		
PC48/1	67	TMBA35K2	191	TMBRT25D	188		
PC48/1	202	TMBA35L1	191	TMBSRC700A	192		
PC49/1	203	TMBA35L2	191	TMBSRC700B	192		
PC49/2	203	TMBB109C	187	TMBST11R	188		
PC50/1	202	TMBB112C	189	TMBST22R	190		

A series of horizontal dotted lines for writing notes.

***FOR STRUCTURAL STEEL AND  
OTHER METALS RELY ON...***



Located conveniently adjacent to Iron Age Architectural Metals, **Surplus Steel & Supply** has been serving East Central Florida since 1980. As a family owned and operated business, we provide excellent customer service with our quick quotes, helpful staff, and wide variety of metal products, including galvanized “B” deck, ornamental forgings, trailer parts, welding supplies, and primer paint.



Surplus Steel & Supply carries the largest selection of high-quality secondary steel in all the state of Florida. We also carry prime material with mill test reports upon request. If by chance we don't have what you need when you call, we generally can have it within 24-hours from our broad network of steel mill suppliers. We also supply most aluminum and stainless shapes.



We are manufacturers of heavy duty galvanized corrugated roofing for barns, boat docks, and small shops. Since you're dealing direct with the manufacturer, you'll be pleased with our low cost pricing structure. We are Metro-Orlando's largest stocking distributor of culvert for driveways and drainage pipe.

***Rely on Surplus Steel & Supply and Iron Age Architectural Metals as your  
“one-stop” metals supplier.***

**Surplus Steel & Supply, Inc.  
3015 Gamson Road  
Apopka, FL 32703  
Phone: 407.293.5788 or 800.299.5788  
Fax# 407-297-3972  
Email: [steve@ironagemetals.com](mailto:steve@ironagemetals.com)**



P.O. Box 607976  
Orlando, FL 32860-7976



Are you currently ordering ornamental iron components from an out-of-town supplier? Are you tired of paying high shipping costs?

Come to Iron Age! Our Warehouse has the largest inventory of ornamental iron in Central Florida and is the only showroom of this type in the state.

Our experienced staff can assist you with design, as well as telephone and special orders. Our large inventory allows us to fill your order on-site. Delivery is available throughout Central Florida.

We are conveniently located at 2401 Clark Street in Apopka adjacent to Surplus Steel and Supply. Showroom hours are Monday through Friday, 8:00 a.m. to 5:00 p.m.

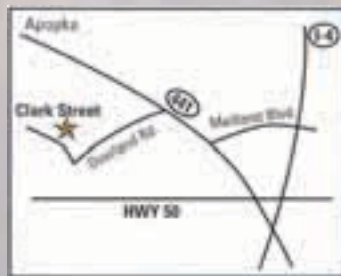

**407-293-5788 • 800-299-5788 • Fax: 407-295-6847**  
**2401 Clark Street • Apopka, FL 32703**  
**[www.ironagemetals.com](http://www.ironagemetals.com)**